

A.J.S. Motor Cycles

1926-1927
4.98 h.p. Models
CATALOGUE
OF
SPARE PARTS.

A. J. Stevens & Co. (1914) Ltd.

WOLVERHAMPTON,

ENGLAND.

TELEPHONE. 1731
(Five Lines.)

CODES:
A.B.C. 5th Edition.
A.B.C. 6th Edition.
Bentley's.

Marconi International.

TELEGRAMS.

"HOTT, Wolverhampton."
England.

Price 2/-

INDEX.

Pages on which Prices and Illustrations will be found.

Description of Part.

Price. Illustration.

Description of Part.	Price.	Illustration.
Instructions for tracing Parts in this } see page 6		
Catalogue ... } see page 7		
Instructions for Agents only ... } see page 7		
Instructions for ordering Sidecar } see page 49		
Chassis or Body Parts...		
Brake (Front Expanding)	22, 23	69
Brake (Rear Expanding)	24, 25	69
Carburettor (Binks) ...	36, 37	73, 76
Carrier ...	27	70, 72
Chains and Links ...	35	73
Chaincases and Chainguards ...	27	70, 72
Chaincase Fittings ...	28	68
Change Speed Parts ...	20	68
Clutch ...	19, 20	67
Control Cables (Carburettor and Clutch)	37	73
Control Cables (Front Brake and Magneto)	38	73
Control Cables (Valve Lifter)	38, 39	73
Control Cables (Separate Oil Tank)	44, 45	72
Control Levers (Carburettor and Clutch)	37	73
Control Levers (Front Brake, Magneto & Valve Lifter)	38	73
Control Levers (Combined Air and Magneto)	39	76
Control Levers (Separate Oil Tank)	44, 45	72
Engine ...	8 to 16	64 to 66
Engine Plates ...	15	66
Exhaust System ...	33, 34, 35	71
Footrests ...	25, 26	74
Footstarter ...	20	68
Forks (Front Springs) ...	30, 31	70
Frame and Fittings ...	31	70
Gearbox ...	16 to 19	67
Grease Gun ...	40	78
Handlebars ...	32	70
Hub (Front) ...	22	69
Hub (Rear) ...	23	69
Knee Grips ...	28	68
Lamps (Electric) ...	46	Not Illustrated
Lighting Sets (Acetylene) ...	47	" 72 "
Leg Shields ...	29, 30	" 72 "
Mudguards (Front) ...	26, 27	71, 72
Mudguards (Rear) ...	27	71
Magneto ...	32, 33	68, 75
Magdyno Lighting Sets and Parts	45, 43, 47	75
Number Plates ...	26, 27	71
Oil Tank (Separate) ...	44, 45	72
Oil Pump (Hand Type) ...	41, 42	77
Oil Pump (Mechanical) ...	42, 43	77
Oil Pump (Mechanical, Sight Feed)	48, 44	77

Description of Part.	Pages on which Prices and Illustrations will be found.	
	Price.	Illustration.
Pannier Tool Cases	27	78
Pipes (Petrol)	29	70
Pipes (Oil)	29	77
Saddles	29	78
Stands (Front and Rear)	31, 32	70
Seat Pillar		
Tank	28, 29	70
Tank Fittings	28, 29	68
Taps	28	68
Tyre Inflator	29	78
Front Roll and Tools	39, 40	78
Head Lamp Carburettor Control (A.J.S.)	40, 41	74
Head Lamp Carburettor Control (Binks)	41	74
Wheels (Front)	21, 22	71
Wheels (Rear)	23, 24	71
DECK, CHASSIS AND BODY SECTION.		
Fronts	61, 62	Not Illustrated
Ries	61	52, 53
Body Fittings	62	Not Illustrated
assis	54	50, 51
injections	57, 58, 59	50, 51
ings for Racing Chassis	59, 60	51
heel and Fittings	55, 56, 57	50, 51
ndscreens	61	Not Illustrated
heel Brake Parts	56, 57	51

4.98 h.p. Spare Parts Catalogue.

Rules to be observed:

(Important Instructions for tracing Parts will be found on Page 6).

- It will greatly facilitate prompt attention to clients' correspondence or requirements if letters or goods are addressed to the Company, and to the department concerned.
- The main departments are as follows:—

New Machines	-	Sales Department.
New Machines for Export	-	Export Sales Department.
Repairs, Overhauls, or Replacements of Parts under Guarantee	-	Repair Department.
Spare Parts	-	Spare Parts Department.
Spare Parts for Export	-	Export Spare Parts Dept.
Accounts	-	Accounts Department.
- Parts sent to us to be repaired, replaced or as pattern, should bear distinctly the sender's full name and address, and explicit instructions should follow by letter of advice stating specifically what is required.
- All goods sent as patterns or for repairs must be consigned **CARRIAGE PAID** or we cannot accept delivery of same. Full particulars should also be given as to how the goods are to be returned, whether crated, uncrated, passenger or goods train. This refers only to complete machines or bulky articles, such as engine, frame, wheels, etc.
- It is **IMPORTANT** that we should be instructed if old parts are required to be returned, as they cannot be held in reserve at our works beyond seven days from date of completion of repair.
- When forwarding a complete Motor Cycle, do not fail to remove all accessories, such as lamp, horn, tools, badges, etc., otherwise we cannot be held responsible for their safe return, although we take every possible precaution in this respect.
- When treasury notes or coin is remitted **do not fail to Register the Letter** as otherwise we do not accept responsibility for the correct amount reaching us.

8. Please do not enclose cheques or money of any kind in parcels sent to the Company. All payments should be made through separate post and the amount stated in letter. We accept no responsibility for loss if money is enclosed in Parcels.

9. If the amount remitted is in excess or insufficient, the matter will be adjusted but clients should advise us if any surplus is to be returned or placed to his credit.

10. If parts are urgently wanted and it is necessary to send us a telegram do not fail to include **FULL NAME and FULL ADDRESS** in the message. Unless this is done the Post Office do not give this information in the telegram. Orders or instructions received by telegram or over the 'Phone must be confirmed by letter enclosing remittance.

In the event of loss or damage to goods when in transit whether sent letter post, parcel post or rail, we hold no responsibility whatever, and any claim for compensation must be made by client.

Estimates.

When sending particulars by letter of work to be done to repairs, or when ordering replacements from our Spares Department, may we earnestly request clients not to mix such instructions with other matter. Tell us about your Motor Cycle on **ONE** sheet and give your instructions or Spares order on another, this may then be handed to the department concerned and your instruction will be executed more expeditiously.

We are sometimes asked by clients when sending their Engines or Motor Cycles etc., for repairs or overhauls to furnish an estimate for the necessary work. We are pleased to do this on the distinct understanding that we reserve the right to charge for any extra work or new parts found necessary to put such machine or engine, etc., in good running order, which it may have been impossible to detect when dismantling.

We prefer not to undertake a repair or overhaul (nor do we accept any responsibility) when the estimate for same has been curtailed by the owner.

If an estimate is not accepted after tender, a charge is made for taking down, re-assembling, and preparing the estimate.

All goods returned by us are consigned Carriage Forward.

All letters must be addressed to our Head Offices:

GRAISELEY HOUSE, WOLVERHAMPTON,
ENGLAND.

Packing Boxes, Crates, etc., are charged at Cost, and are strictly NON-RETURABLE.

Deposit Accounts.

Customers if they choose may open a deposit account with us, in which event goods to the value of the amount standing to their credit will be despatched when either 'phoned, wired, or ordered by post.

Should a client having a deposit account order Spare Parts from a temporary address, it is advisable to quote, besides his deposit a/c reference, his permanent address.

A statement of account will be rendered periodically to all clients having deposit accounts.

All previous Lists are cancelled.

Terms.

Our terms are strictly **NETT CASH** with order, or Cash against **PRO FORMA INVOICE**.

Cheques and Postal Orders to be made payable to **A. J. STEVENS & Co. (1914) LTD.** and Crossed.

A. J. STEVENS & CO. (1914) LTD.

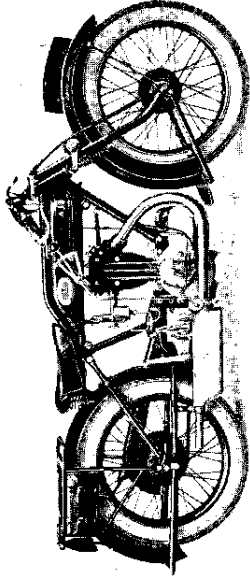

498 h.p. A.J.S. OVERHEAD VALVE MODEL.

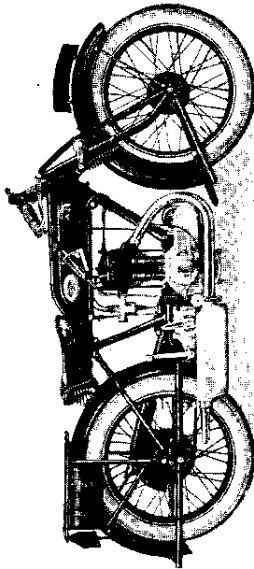

498 h.p. A.J.S. de LUXE TOURING MODEL.

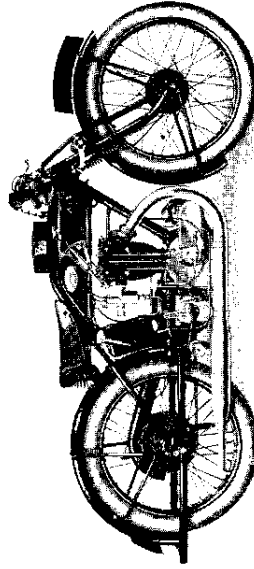

498 h.p. A.J.S. OVERHEAD VALVE RACING MODEL.

List of 498 h.p. Models, 1926-27.

1926	...	Model G8.	O.H.V. Machine.
		"	G10. O.H.V. Racing.
1927	...	Model H8.	O.H.V. Machine.
		"	H9. de Luxe Touring.
		"	H10. O.H.V. Racing.

IMPORTANT.

Spare Parts Orders.

Please read the following particulars carefully:

All parts in this List are illustrated, numbered, and the various models and years of manufacture shown.

Parts illustrated have one number only. If more than one number is used for any particular type of part, they will be found in numerical order on descriptive pages.

Stars (*) under the various models, in line with number and description, denote the actual model or models for which that part is suitable.

To trace, two courses are available. Firstly, by referring to illustration and noting number. Secondly, by referring to Index which shows section in List under which a certain part or parts are to be found, all similar type parts being grouped.

It is important, of course, that the model and year is known. As an example:—If a crankpin is required for an H9 1927 O.H.V. Machine, a star will be found in this column opposite to and in line with Part No. G4 on Page 8. It will also be noticed that the same Crankpin is used on all 4.98 h.p. Machines, both Side Valve and O.H.V., made during 1926 and 1927.

If replacements are required for Parts not fitted as standard, please give full particulars.

When ordering, give Part Number, Description of Part, Model and Year.

When the Model and Year is in doubt quote Engine Number stamped on Brass Plate on the driving side of crankcase. (See Page 7 for illustration).

Additional Particulars, for Agents only.

In addition to showing the interchangeability of parts with various models in this List, the interchangeability of any particular part with 3.49 h.p. model or models is indicated by **3.49 h.p. List Number** being shown in the **3.49 h.p. column** on the descriptive page.

For Example:—If Part No. G51 (which is a Magneto Engine Sprocket) is referred to, it will be found that it is suitable for all models in this List. Against this in the **3.49 h.p. column** the corresponding **3.49 h.p. List Number H289** is found, and if this number is referred to in both the 1921-24 and the 1925-27 3.49 h.p. Lists it will be noticed that it is suitable for all 3.49 h.p. machines. Therefore, Part No. G51 is interchangeable with all 4.98 h.p. and 3.49 h.p. models.

The same method is employed in other Lists.

Many small parts in this List are absolutely identical (i.e. Nuts, Washers, Screws, Pins, etc.) and are used more than once in the assembly of each machine. These same parts are specified in each of their respective sections, but the same number has been employed throughout. Where any such part is repeated the number (which should be quoted) is shown in brackets.

POSITION OF ENGINE NUMBER.

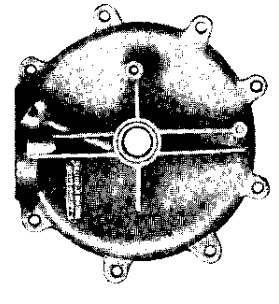

(See Page 7 for illustration).

Quote Part Number, Name of Part, Model, and Year, when Ordering. 4 98 h.p. 1926-27 A.J.S. Motor Cycles.

NOTE * Indicates models for which Part is suitable. For Agent's Use. 3-49 h.p. List No.

Part No.	1926 MODELS				1927 MODELS			
	G8 OHV	G10 OHV	H8 OHV	H9 SV	G8 OHV	G10 OHV	H8 OHV	H9 SV

Engine.

Part No.	DESCRIPTION OF PART.	G8 OHV	G10 OHV	H8 OHV	H9 SV
G1	Cylinder Head with Valve Guides ..	*	*	*	*
G1-1	Cylinder Head with Valve Guides ..	*	*	*	*
G1-2	Cylinder Head with Valve Guides ..	*	*	*	*
G1-3	Cylinder Head with Valve Guides ..	*	*	*	*
G1-4	Cylinder Head with Valve Guides (this part is interchangeable with G1-1)	*	*	*	*
G1-5	Cylinder Head with Valve Guides ..	*	*	*	*
G1-6	Cylinder Head with Valve Guides ..	*	*	*	*
G1-7	Cylinder Head with Valve Guides ..	*	*	*	*
G1-8	Cylinder Head with Valve Guides ..	*	*	*	*
G1-9	Cylinder Head with Valve Guides ..	*	*	*	*
G1-10	Cylinder Head with Valve Guides ..	*	*	*	*
G1-11	Cylinder Head with Valve Guides ..	*	*	*	*
G1-12	Cylinder Head with Valve Guides ..	*	*	*	*
G1-13	Cylinder Head with Valve Guides ..	*	*	*	*
G1-14	Cylinder Head with Valve Guides ..	*	*	*	*
G1-15	Cylinder Head with Valve Guides ..	*	*	*	*
G1-16	Cylinder Head with Valve Guides ..	*	*	*	*
G1-17	Cylinder Head with Valve Guides ..	*	*	*	*
G1-18	Cylinder Head with Valve Guides ..	*	*	*	*
G1-19	Cylinder Head with Valve Guides ..	*	*	*	*
G1-20	Cylinder Head with Valve Guides ..	*	*	*	*
G1-21	Cylinder Head with Valve Guides ..	*	*	*	*
G1-22	Cylinder Head with Valve Guides ..	*	*	*	*
G1-23	Cylinder Head with Valve Guides ..	*	*	*	*
G1-24	Cylinder Head with Valve Guides ..	*	*	*	*
G1-25	Cylinder Head with Valve Guides ..	*	*	*	*
G1-26	Cylinder Head with Valve Guides ..	*	*	*	*
G1-27	Cylinder Head with Valve Guides ..	*	*	*	*
G1-28	Cylinder Head with Valve Guides ..	*	*	*	*
G1-29	Cylinder Head with Valve Guides ..	*	*	*	*
G1-30	Cylinder Head with Valve Guides ..	*	*	*	*
G1-31	Cylinder Head with Valve Guides ..	*	*	*	*
G1-32	Cylinder Head with Valve Guides ..	*	*	*	*
G1-33	Cylinder Head with Valve Guides ..	*	*	*	*
G1-34	Cylinder Head with Valve Guides ..	*	*	*	*
G1-35	Cylinder Head with Valve Guides ..	*	*	*	*
G1-36	Cylinder Head with Valve Guides ..	*	*	*	*
G1-37	Cylinder Head with Valve Guides ..	*	*	*	*
G1-38	Cylinder Head with Valve Guides ..	*	*	*	*
G1-39	Cylinder Head with Valve Guides ..	*	*	*	*
G1-40	Cylinder Head with Valve Guides ..	*	*	*	*
G1-41	Cylinder Head with Valve Guides ..	*	*	*	*
G1-42	Cylinder Head with Valve Guides ..	*	*	*	*
G1-43	Cylinder Head with Valve Guides ..	*	*	*	*
G1-44	Cylinder Head with Valve Guides ..	*	*	*	*
G1-45	Cylinder Head with Valve Guides ..	*	*	*	*
G1-46	Cylinder Head with Valve Guides ..	*	*	*	*
G1-47	Cylinder Head with Valve Guides ..	*	*	*	*
G1-48	Cylinder Head with Valve Guides ..	*	*	*	*
G1-49	Cylinder Head with Valve Guides ..	*	*	*	*
G1-50	Cylinder Head with Valve Guides ..	*	*	*	*
G1-51	Cylinder Head with Valve Guides ..	*	*	*	*
G1-52	Cylinder Head with Valve Guides ..	*	*	*	*
G1-53	Cylinder Head with Valve Guides ..	*	*	*	*
G1-54	Cylinder Head with Valve Guides ..	*	*	*	*
G1-55	Cylinder Head with Valve Guides ..	*	*	*	*
G1-56	Cylinder Head with Valve Guides ..	*	*	*	*
G1-57	Cylinder Head with Valve Guides ..	*	*	*	*
G1-58	Cylinder Head with Valve Guides ..	*	*	*	*
G1-59	Cylinder Head with Valve Guides ..	*	*	*	*
G1-60	Cylinder Head with Valve Guides ..	*	*	*	*
G1-61	Cylinder Head with Valve Guides ..	*	*	*	*
G1-62	Cylinder Head with Valve Guides ..	*	*	*	*
G1-63	Cylinder Head with Valve Guides ..	*	*	*	*
G1-64	Cylinder Head with Valve Guides ..	*	*	*	*
G1-65	Cylinder Head with Valve Guides ..	*	*	*	*
G1-66	Cylinder Head with Valve Guides ..	*	*	*	*
G1-67	Cylinder Head with Valve Guides ..	*	*	*	*
G1-68	Cylinder Head with Valve Guides ..	*	*	*	*
G1-69	Cylinder Head with Valve Guides ..	*	*	*	*
G1-70	Cylinder Head with Valve Guides ..	*	*	*	*
G1-71	Cylinder Head with Valve Guides ..	*	*	*	*
G1-72	Cylinder Head with Valve Guides ..	*	*	*	*
G1-73	Cylinder Head with Valve Guides ..	*	*	*	*
G1-74	Cylinder Head with Valve Guides ..	*	*	*	*
G1-75	Cylinder Head with Valve Guides ..	*	*	*	*
G1-76	Cylinder Head with Valve Guides ..	*	*	*	*
G1-77	Cylinder Head with Valve Guides ..	*	*	*	*
G1-78	Cylinder Head with Valve Guides ..	*	*	*	*
G1-79	Cylinder Head with Valve Guides ..	*	*	*	*
G1-80	Cylinder Head with Valve Guides ..	*	*	*	*
G1-81	Cylinder Head with Valve Guides ..	*	*	*	*
G1-82	Cylinder Head with Valve Guides ..	*	*	*	*
G1-83	Cylinder Head with Valve Guides ..	*	*	*	*
G1-84	Cylinder Head with Valve Guides ..	*	*	*	*
G1-85	Cylinder Head with Valve Guides ..	*	*	*	*
G1-86	Cylinder Head with Valve Guides ..	*	*	*	*
G1-87	Cylinder Head with Valve Guides ..	*	*	*	*
G1-88	Cylinder Head with Valve Guides ..	*	*	*	*
G1-89	Cylinder Head with Valve Guides ..	*	*	*	*
G1-90	Cylinder Head with Valve Guides ..	*	*	*	*
G1-91	Cylinder Head with Valve Guides ..	*	*	*	*
G1-92	Cylinder Head with Valve Guides ..	*	*	*	*
G1-93	Cylinder Head with Valve Guides ..	*	*	*	*
G1-94	Cylinder Head with Valve Guides ..	*	*	*	*
G1-95	Cylinder Head with Valve Guides ..	*	*	*	*
G1-96	Cylinder Head with Valve Guides ..	*	*	*	*
G1-97	Cylinder Head with Valve Guides ..	*	*	*	*
G1-98	Cylinder Head with Valve Guides ..	*	*	*	*
G1-99	Cylinder Head with Valve Guides ..	*	*	*	*
G1-100	Cylinder Head with Valve Guides ..	*	*	*	*

*NOTE: When this part requires renewing it is necessary to send Connecting Rod to our Repairs Dept. to have same fitted.

Quote Part Number, Name of Part, Model, and Year, when Ordering. 4 98 h.p. 1926-27 A.J.S. Motor Cycles.

NOTE * Indicates models for which Part is suitable. For Agent's Use. 3-49 h.p. List No.

Part No.	1926 MODELS				1927 MODELS			
	G8 OHV	G10 OHV	H8 OHV	H9 SV	G8 OHV	G10 OHV	H8 OHV	H9 SV

Engine—Continued.

Part No.	DESCRIPTION OF PART.	G8 OHV	G10 OHV	H8 OHV	H9 SV
G14	Piston, complete with Rings, Gudgeon Pin &c. Low compression	*	*	*	*
G14-1	Piston, complete with Rings, Gudgeon Pin, &c. High compression	*	*	*	*
G14-2	Piston, complete with Rings, Gudgeon Pin, &c. Low compression	*	*	*	*
G14-3	Piston, complete with Rings, Gudgeon Pin, &c. High compression	*	*	*	*
G14-4	Piston, complete with Rings, Gudgeon Pin, &c.	*	*	*	*
G15	Piston Body only. Low compression	*	*	*	*
G15-1	Piston Body only. High compression	*	*	*	*
G15-2	Piston Body only. Low compression	*	*	*	*
G15-3	Piston Body only. High compression	*	*	*	*
G15-4	Piston Body only each.	*	*	*	*
G16	Piston Rings each.	*	*	*	*
G17	Valve, complete with Springs, &c. Inlet or Exhaust	*	*	*	*
G17-1	Valve, complete with Springs, &c. Inlet or Exhaust	*	*	*	*
G18	Valve Stem only. Inlet or Exhaust	*	*	*	*
G18-1	Valve Stem only. Inlet or Exhaust	*	*	*	*
G19	Valve Spring complete	*	*	*	*
G19-1	Valve Spring	*	*	*	*
G20	Outer Valve Spring	*	*	*	*
G21	Inner Valve Spring	*	*	*	*
G22	Valve Guide	*	*	*	*
G22-1	Valve Guide	*	*	*	*
G22-2	Inlet valve Cap	*	*	*	*
G22-3	Exhaust Valve Cap	*	*	*	*
G22-4	Valve Cap Washer	*	*	*	*
G22-5	Compression Tap	*	*	*	*
G22-6	Compression Tap Washer	*	*	*	*
G23	Valve Spring Dish	*	*	*	*

*NOTE: When this part requires renewing it is necessary to send Connecting Rod to our Repairs Dept. to have same fitted.

Quote Part Number, Name of Part, Model, and Year, when Ordering. 4-98 h.p. 1926-27 A J.S. Motor Cycles.

NOTE * Indicates models for which Part is suitable. For Agent's Use 1926 MODELS 1927 MODELS

Part No.	DESCRIPTION OF PART.	For Agent's Use	1926 MODELS	1927 MODELS	Part No.	DESCRIPTION OF PART.	For Agent's Use	1926 MODELS	1927 MODELS		
		3-49 h.p. List No.	G8 OHV	G10 OHV	H9 OHV	H10 OHV		G8 OHV	G10 OHV	H9 OHV	H10 OHV
G23-1	Valve Spring Dish or Cup		*	*	*	*	H112	*	*	*	*
G24	Valve Spring Cone without Split collar		*	*	*	*	H111	*	*	*	*
G24-1	Valve Spring Cone		*	*	*	*	H109	*	*	*	*
G25	Valve Spring Comp. Split Collar		*	*	*	*	H117	*	*	*	*
G26-1	Valve Control		*	*	*	*	H115	*	*	*	*
G26-2	Valve Control Lever		*	*	*	*	H123	*	*	*	*
G27	Valve Control Spring		*	*	*	*	H132	*	*	*	*
G27-1	Valve Control Spring (Comp. 24 Lbs)		*	*	*	*	H133	*	*	*	*
G27-2	Valve Washer for above (1 in.)		*	*	*	*	H134	*	*	*	*
G28	Inlet Tappet Rod only		*	*	*	*	H135	*	*	*	*
G28-1	Inlet Tappet Rod only		*	*	*	*	H143	*	*	*	*
G28-2	Inlet Tappet Rod only		*	*	*	*		*	*	*	*
G28-3	Inlet Tappet Rod only		*	*	*	*		*	*	*	*
G29	Exhaust Tappet Rod only		*	*	*	*		*	*	*	*
G29-1	Exhaust Tappet Rod only		*	*	*	*		*	*	*	*
G29-2	Exhaust Tappet Rod only		*	*	*	*	H139	*	*	*	*
G29-3	Exhaust Tappet Rod only		*	*	*	*		*	*	*	*
G30	Tappet Stands	each	*	*	*	*	H149	*	*	*	*
G31	Tappet Tops (Inlet or Exhaust)	each	*	*	*	*	H147	*	*	*	*
G31-1	Tappet Tops (Inlet or Exhaust)	each	*	*	*	*		*	*	*	*
G32	Tappet Lock Nuts (Inlet or Exhaust)	each	*	*	*	*	H144	*	*	*	*
G33	Tappet Guides (Inlet)		*	*	*	*	H150	*	*	*	*
G33-1	Tappet Guides (Inlet)		*	*	*	*	H151	*	*	*	*
G33-2	Tappet Guides (Inlet)		*	*	*	*		*	*	*	*
G34	Tappet Guides (Exhaust)		*	*	*	*		*	*	*	*
G34-1	Tappet Guides (Exhaust)		*	*	*	*	H152	*	*	*	*
G34-2	Tappet Guides (Exhaust)		*	*	*	*		*	*	*	*

Engine—Continued.

Engine—Continued.

Quote Part Number, Name of Part, Model, and Year, when Ordering. 4-98 h.p. 1926-27 A J.S. Motor Cycles.

NOTE * Indicates models for which Part is suitable. For Agent's Use 1926 MODELS 1927 MODELS

Part No.	DESCRIPTION OF PART.	For Agent's Use	1926 MODELS	1927 MODELS		
		3-49 h.p. List No.	G8 OHV	G10 OHV	H9 OHV	H10 OHV
H193	Mainshaft (Timing Side)		*	*	*	*
H194	Mainshaft (Timing Side)		*	*	*	*
H204	Mainshaft Nut (Timing Side) (as G5)		*	*	*	*
H205	Mainshaft Bush (Timing Side)		*	*	*	*
H206	Mainshaft Outer Race (Timing Side)		*	*	*	*
H207	Mainshaft Outer Race (Timing Side)		*	*	*	*
H208	Mainshaft (Driving Side)		*	*	*	*
H209	Mainshaft (Driving Side)		*	*	*	*
H210	Mainshaft (Driving Side)		*	*	*	*
H211	Woodruff Key for Mainshafts No. 6 (as G31-1)		*	*	*	*
H212	Mainshaft Nut (Driving Side) (as G5)		*	*	*	*
H213	Mainshaft Bush (Driving Side)		*	*	*	*
H214	Mainshaft Outer Race (Driving Side)		*	*	*	*
H215	Mainshaft Outer Race (Driving Side)		*	*	*	*
H216	Distance Piece for Mainshaft (Timing Side)		*	*	*	*
H217	Distance Piece for Mainshaft (Timing Side)		*	*	*	*
H218	Distance Piece for Mainshaft (Driving Side)		*	*	*	*
H219	Distance Piece for Mainshaft (Driving Side)		*	*	*	*
H220	Washers for Mainshafts		*	*	*	*
H221	Washers for Mainshafts		*	*	*	*
H222	Felt Washer for Mainshaft (Driving Side)		*	*	*	*
H223	Rollers for Mainshaft (5.16 x 5.16 in.) (Timing Side, set 11)		*	*	*	*
H224	Rollers for Mainshaft (5.16 x 5.16 in.) (Driving Side, set 22)		*	*	*	*
H225	Inlet Camwheel		*	*	*	*
H226	Inlet Camwheel		*	*	*	*
H227	Exhaust Camwheel		*	*	*	*

Where Part Number is given in brackets this number should be quoted.

Quote Part Number, Name of Part, Model, and Year, when Ordering. 4.98 h.p. 1926-27 A.J.S. Motor Cycles.

NOTE * Indicates models for which Part is suitable. For Agent's Use. 1926 MODELS: G8 OHV, G10 OHV, H9 SV, H10 OHV. 1927 MODELS: H8 OHV, H9 SV, H10 OHV. 3.49 h.p. List No.

Part No.	DESCRIPTION OF PART.	1926 MODELS	1927 MODELS	1928 MODELS
		G8 OHV	H9 SV	H10 OHV
G42-1	Exhaust Camwheel	*	*	*
G43	Timing Pinion only	*	*	*
G44	Timing Pinion Lock Nut	*	*	*
G45	Inlet Camshaft	*	*	*
G45-1	Inlet Camshaft	*	*	*
G46	Exhaust Camshaft	*	*	*
G46-1	Exhaust Camshaft	*	*	*
G47	Exhaust Camshaft Crankcase Bush	*	*	*
G48	Exhaust Camshaft Timing Cover Bush	*	*	*
G49	Inlet Camshaft Crankcase Bush	*	*	*
G50	Inlet Camshaft Timing Cover Blind Bush	*	*	*
G50-1	Ballraces for Camshafts	each	each	each
G51	Magneto Sprocket on Engine	*	*	*
G52	Magneto Sprocket Nut on Engine	*	*	*
G52-1	Keys for Exhaust Camshaft (Woodruffe No. 3, small)	*	*	*
G53	Inlet Rocker	*	*	*
G53-1	Inlet Rocker	*	*	*
G54	Exhaust Rocker	*	*	*
G54-1	Exhaust Rocker	*	*	*
G54-2	Grease Nipples for Rockers	each	each	each
G55	Rocker Ball-ended Stud	*	*	*
G55-1	Rocker Ball-ended Stud	*	*	*
G55-2	Locking Pin for above in Rocker Arm	*	*	*
G55-3	Nut for Locking Pin	*	*	*
G56	Rocker Bush (Not now used)	*	*	*

* In the early part of 1927 the Inlet and Exhaust Camshafts were altered. The centre part of the shaft on which the Cam fits is now plain, whereas the early type had a thin flange or collar at the back, similar to 1926 type. When ordering, state if plain or flanged.

Quote Part Number, Name of Part, Model, and Year, when Ordering. 4.98 h.p. 1926-27 A.J.S. Motor Cycles.

NOTE * Indicates models for which Part is suitable. For Agent's Use. 1926 MODELS: G8 OHV, G10 OHV, H9 SV, H10 OHV. 1927 MODELS: H8 OHV, H9 SV, H10 OHV. 3.49 h.p. List No.

Part No.	DESCRIPTION OF PART.	1926 MODELS	1927 MODELS	1928 MODELS
		G8 OHV	H9 SV	H10 OHV
H182	Rocker Spindle, less nuts	*	*	*
H183	Rocker Spindle Nut (3/16 in. 26 Tnd.)	*	*	*
H160	Rocker Spindle Washer (3/16 in.)	*	*	*
H175	Rocker Stud Valve End	*	*	*
H175-1	Tappet Tube complete	*	*	*
H175-2	Tappet Tube complete	*	*	*
H175-3	Tappet Tube complete	*	*	*
H189	Tappet Tube Rubbers	pair	pair	pair
H159	Rocker Plates	each	each	each
H162	Rocker Plates	each	each	each
H161	Rocker Plate Pin (3/16 in., 20 Tnd.)	*	*	*
H164	Rocker Plate Spindle Nuts (5/16 in., 26 Tnd.)	each	each	each
H306	Rocker Plate Spindle only	*	*	*
H307	Rocker Plate Distance Tube	*	*	*
H307-1	Turnbuckles	each	each	each
H307-2	Turnbuckle Stud	each	each	each
H307-3	Turnbuckle Stud Pin	each	each	each
H307-4	Crankcase only (Timing Side)	*	*	*
H307-5	Crankcase only with Races (Timing Side)	*	*	*
H307-6	Crankcase only (Timing side)	*	*	*
H307-7	Crankcase only (Timing Side)	*	*	*
H307-8	Crankcase only with Races (Timing Side)	*	*	*
H307-9	Crankcase only (Driving Side)	*	*	*
H307-10	Crankcase only (Driving Side)	*	*	*
H307-11	Crankcase only (Driving Side)	*	*	*
H307-12	Crankcase only (Driving Side)	*	*	*

* During the early part of 1927 the width of the four top lugs on the H8 and H10 Crankcases were altered from 2 to 2 1/2 in. When replacements are required for Crankcases, Engine Plates, Engine Bolts, and Magneto Platforms of either of the above models, state width of top lugs.

Quote Part Number, Name of Part, Model, and Year when Ordering. 4.98 h p 1926-27 A.J.S. Motor Cycles.

NOTE * Indicates models for which Part is suitable. For Agent's Use: 1926 MODELS 1927 MODELS 3-49 h.p. OHV, OHV, OHV, SV, OHV List No.

Part No.	DESCRIPTION OF PART.	1926 MODELS				1927 MODELS			
		G8	G10	H8	H9	G8	G10	H8	H9
		OHV	OHV	OHV	OHV	OHV	OHV	SV	OHV
G69-3	Crankcase only. Driving Side	*	*	*	*	*	*	*	*
G70	Timing Cover, fitted with Bushes	*	*	*	*	*	*	*	*
G70-1	Timing Cover, fitted with Ballraces	*	*	*	*	*	*	*	*
G70-2	Timing Cover, fitted with Bushes	*	*	*	*	*	*	*	*
G71	Magneto Chain Cover	*	*	*	*	*	*	*	*
G71-1	Magneto Chain Cover	*	*	*	*	*	*	*	*
G71-2	Magneto Chain Cover	*	*	*	*	*	*	*	*
G71-3	Magneto Chain Cover	*	*	*	*	*	*	*	*
G72	Oil Release Pipe, with Nut	*	*	*	*	*	*	*	*
G72-1	Union only for above, in Crankcase								
G73	Flywheel (Timing Side)...								
G73-1	Flywheel (Timing Side)...								
G73-2	Flywheel (Timing Side)...								
G73-3	Flywheel (Timing Side)...								
G74	Flywheel (Driving Side)								
G74-1	Flywheel (Driving Side)								
G74-2	Flywheel (Driving Side)								
G74-3	Flywheel (Driving Side)								
*G75	Engine Bolt only (3-5/16 x 3 in., 26 Thd.)	*	*	*	*	*	*	*	*
*G76	Engine Bolt only (3-11/16 x 3 in., 26 Thd.)	*	*	*	*	*	*	*	*
*G77	Engine Bolt only (4-1/8 x 3 in., 26 Thd.)	*	*	*	*	*	*	*	*
*G78	Engine Bolt only (4-1/8 x 3 in., 26 Thd.)	*	*	*	*	*	*	*	*
G79-1	3 in. Nuts for above (25 Thd.) (as G58) each								
G79	Washer for above (3 in.)								
*G80	Engine Bolt for Brake Pedal Plate, with Nut								

* During the early part of 1927 the width of the four top lugs on the H8 and H10 Crankcases were altered from 2 in. to 2 1/8 in. When replacements are required for Crankcases, Engine Plates, Engine Bolts, and Magneto Platforms of either of the above models state width of Top Lugs.

Where Part Number is given in brackets this number should be quoted.

Part Number, Name of Part, Model, and Year when Ordering. 4.98 h.p. 1926-27 A.J.S. Motor Cycles.

NOTE * Indicates models for which Part is suitable. For Agent's Use: 1926 MODELS 1927 MODELS 3-49 h.p. OHV, OHV, OHV, SV, OHV List No.

Part No.	DESCRIPTION OF PART.	1926 MODELS				1927 MODELS			
		G8	G10	H8	H9	G8	G10	H8	H9
		OHV	OHV	OHV	OHV	OHV	OHV	SV	OHV
G81	Engine Steady Rod (Driving Side)	*	*	*	*	*	*	*	*
G81-1	Engine Steady Rod (Driving Side)	*	*	*	*	*	*	*	*
G81-2	Engine Steady Rod (Timing Side)	*	*	*	*	*	*	*	*
G81-3	Engine Steady Rod (Timing Side)	*	*	*	*	*	*	*	*
G81-4	Engine Steady Rod	*	*	*	*	*	*	*	*
G81-5	Engine Steady Rod Clip...	*	*	*	*	*	*	*	*
G81-6	Engine Steady Rod Clip...	*	*	*	*	*	*	*	*
G81-7	Pin and Nut for above (5/16 x 1/2 in., 20 Thd.)								
G81-8	Engine Plates... per set of 4...								
G81-9	Engine Plates... per set of 4...								
G81-10	Engine Plates... per set of 4...								
G81-11	Engine Sprocket Cover								
G81-12	Engine Sprocket (State Number of Teeth)								
G81-13	Engine Sprocket (State Number of Teeth)...								
G81-14	Engine Sprocket Driving Dog								
G81-15	Engine Sprocket Sleeve								
G81-16	Engine Sprocket Sleeve Nut								
G81-17	Engine Shock Absorber Spring								
G81-18	Engine Shock Absorber Adjusting Nut								
G81-19	Engine Shock Absorber Spring Cotter								
G81-20	Magneto Platform								
G81-21	Magneto Platform Pins and Washers (3 x 3/4 in. in Thd.)								
G81-22	Magneto Shield Pin and Nut (1 x 3/4 in., 20 Thd.)								
G81-23	Magneto Chain Cover Pin (4 x 1 1/4 in., small hexagon head)								
G81-24	Timing Cover Pin (4 x 1 1/4 in., small hexagon head) (as G295)								

* During the early part of 1927 the width of the four top lugs on the H8 and H10 Crankcases were altered from 2 in. to 2 1/8 in. When replacements are required for Crankcases, Engine Plates, Engine Bolts, and Magneto Platforms of either of the above models state width of top lugs.

When Part Number is given in brackets this number should be quoted.

Quote Part Number, Name of Part, Model, and Year when Ordering. **4.98 h.p. 1926-27 A.J.S. Motor Cycles.**

Part No.	DESCRIPTION OF PART.	1926 MODELS			1927 MODELS		
		G8 OHV	G10 OHV	H8 OHV	H9 OHV	H10 SV	H11 OHV
G98	Crankcase Oil Plug	*	*	*	*	*	*
G99	Crankcase Oil Plug Washer (as G22-6)						
G100	Oil Pipe Union in Crankcase Driving Side	*	*	*	*	*	*
G101	Oil Pipe Union in Crankcase Timing Side	*	*	*	*	*	*
G101	Valve Lifter Spring	*	*	*	*	*	*
Gear Box.							
G102	Gearbox, complete with Clutch & Footstarter	*	*	*	*	*	*
G102-1	Gearbox, complete with Clutch only						
G102-2	Gearbox, complete with Clutch & Footstarter						
G102-3	Gearbox, complete with Clutch only						
G103	Gearbox Shell, with Cover, less Bearings	*	*	*	*	*	*
G103-1	Gearbox Shell, with Cover, less Bearings						
G103-2	Gearbox Shell, with Cover, less Bearings						
G103-3	Gearbox Shell, with Cover, less Bearings						
G104	Gearbox Shell, with Cover and Bearings	*	*	*	*	*	*
G104-1	Gearbox Shell, with Cover and Bearings						
G104-2	Gearbox Shell, with Cover and Bearings						
G104-3	Gearbox Shell, with Cover and Bearings						
G105	Gearbox Shell only, less Bearings	*	*	*	*	*	*
G105-1	Gearbox Shell only less Bearings						
G106	Gearbox Shell only, with Bearings	*	*	*	*	*	*
G106-1	Gearbox Shell only, with Bearings						
G106-2	Felt Washer for Gearbox Shell						
G107	Gearbox Cover only, less Bearings	*	*	*	*	*	*
G107-1	Gearbox Cover only, less Bearings						
G107-2	Gearbox Cover only, less Bearings						
G107-3	Gearbox Cover only, less Bearings						

Where Part Number is given in brackets this number should be quoted.

Part Number, Name of Part, Model, and Year when Ordering. **4.98 h.p. 1926-27 A.J.S. Motor Cycles.**

Part No.	DESCRIPTION OF PART.	1926 MODELS			1927 MODELS		
		G8 OHV	G10 OHV	H8 OHV	H9 OHV	H10 OHV	H11 OHV
Gear Box—Continued.							
H323	Gearbox Cover only with Bearings	*	*	*	*	*	*
H324	Gearbox Cover only with Bearings						
H381	Gearbox Cover only with Bearings	*	*	*	*	*	*
H382	Gearbox Cover only with Bearings						
H395	Gearbox Bearing, large (62m.m.)	*	*	*	*	*	*
H396	Gearbox Bearing (37m.m.)	*	*	*	*	*	*
H398	Gearbox Cover Pin (5 16 x 1 1/2 in., 20 Thd.) large head	*	*	*	*	*	*
H399	Gearbox Stud with Nut and Washer	*	*	*	*	*	*
H400	Nut only for Gearbox Studs	*	*	*	*	*	*
H401	Washer only for above (7 16 in., plain)	*	*	*	*	*	*
H402	Gearbox Sprocket	*	*	*	*	*	*
H403	Gearbox Sprocket						
H404	Gearbox Sprocket						
H411	High Speed Dog Lock Nut	*	*	*	*	*	*
H478	Pin for fixing Footstart Tube (1/4 x 1 1/2 in., 20 Thd., large head)	*	*	*	*	*	*
H423	Gearbox Adjusting Bolt	*	*	*	*	*	*
H402	Gearbox Adjusting Sleeve	*	*	*	*	*	*
H407	High Speed Dog with Bush (Wide Ratio) (Not supplied without Bush)	*	*	*	*	*	*
H412	High Speed Dog with Bush, (Close Ratio)	*	*	*	*	*	*
H413	Locking Device and Pin for High Speed Dog Lock Nut	*	*	*	*	*	*
H419	Pin only for above (3 16 x 1/2 in., 24 Thd.)	*	*	*	*	*	*
H421	Low Speed Dog, (Wide Ratio)	*	*	*	*	*	*
H421	Low Speed Dog (Close Ratio)	*	*	*	*	*	*
H421	Sliding Dog (Wide and Close Ratio)	*	*	*	*	*	*
H421	Sliding Dog (Close Ratio)	*	*	*	*	*	*
H421	Sliding Dog (Wide and Close Ratio)	*	*	*	*	*	*

NOTE * Indicates models for which Part is suitable.

For Agent's Use, 3-49h.p. List No.

Quote Part Number, Name of Part, Model, and Year when Ordering. 4.98 h.p. 1926-27 A.J.S. Motor Cycles.

Part No.	DESCRIPTION OF PART.	NOTE * Indicates models for which Part is suitable.			
		For Agent's Use.	1926 MODELS	1927 MODELS	1928 MODELS
		3-49 h.p. List No.	OHV OHV OHV	OHV SV OHV	H9 H9 SV OHV
G124-3	Sliding Dog (Close Ratio)		*	*	*
G125	Layshaft complete (Wide Ratio)		*	*	*
G126	Layshaft complete (Close Ratio)		*	*	*
G127	Large Layshaft Wheel (Wide Ratio)		*	*	*
G128	Medium Layshaft Wheel (Wide and Close Ratio)		*	*	*
G129	Small Layshaft Wheel (Wide Ratio)		*	*	*
G130	Large Layshaft Wheel (Close Ratio)		*	*	*
G131	Small Layshaft Wheel (Close Ratio)		*	*	*
G132	No. 6 Woodruffe Key for Layshaft Wheels (as G38-3)		*	*	*
G132-1	Layshaft Spindle		*	*	*
G133	Layshaft Spindle		*	*	*
G133	Gearbox Mainshaft		*	*	*
G133-1	Gearbox Mainshaft		*	*	*
G134	Gearbox Oil Level Lever		*	*	*
G135	Gearbox Oil Level Lever Pin		*	*	*
G135-1	Spring Washer for above		*	*	*
G136	Gearbox Oil Filler Plug		*	*	*
G137	Thrust Washer		*	*	*
G138	Thrust Washer Lock Nut		*	*	*
G139	Thrust Washer Cage		*	*	*
G140	Gearshifter Arch and Arm		*	*	*
G140-1	Gearshifter Arch and Arm		*	*	*
G140-2	Gear Shifter Arch only		*	*	*
G140-3	Gearshifter Arch only		*	*	*
G141	Gearshifter Bush		*	*	*
G141-1	Gearshifter Bush		*	*	*
G142	Washer (not now used)		*	*	*

Where Part Number is given in brackets this number should be quoted

Quote Part Number, Name of Part, Model, and Year when Ordering. 4.98 h.p. 1926-27 A.J.S. Motor Cycles.

Part No.	DESCRIPTION OF PART.	NOTE * Indicates models for which Part is suitable.			
		For Agent's Use.	1926 MODELS	1927 MODELS	1928 MODELS
		3-49 h.p. List No.	OHV OHV OHV	OHV SV OHV	H9 H9 SV OHV
G143	Gear Shifter Lever		*	*	*
G144	Pin for Split End of Gear Shifter Lever (1 1/2 in., 20 Tnd.)		*	*	*
G145	Clutch.		*	*	*
G145	Clutch Sprocket with Bearing		*	*	*
G145-1	Clutch Sprocket with Bearing		*	*	*
G145-2	Clutch Sprocket Bearing only		*	*	*
G146	Clutch Floating Plate		*	*	*
G147	Clutch Fixed Plate		*	*	*
G148	Clutch Sliding Plate		*	*	*
G149	Clutch Sliding Plate Key		*	*	*
G150	Inner Clutch Dished Plate		*	*	*
G151	Clutch Floating Plate Rollers		*	*	*
G152	Clutch Spring		*	*	*
G153	Clutch Spring		*	*	*
G154	Clutch Spring Disc		*	*	*
G155	Clutch Spring Disc		*	*	*
G156	Clutch Spring Nut		*	*	*
G157	Clutch Spring Nut		*	*	*
G158	Clutch Spring Washer		*	*	*
G159	Clutch Spring Washer		*	*	*
G160	Short Push Rod		*	*	*
G161	Clutch Adjusting Pin Lock Nut		*	*	*
G162	Clutch Adjusting Pin		*	*	*
G163	Long Push Rod		*	*	*
G164	Long Push Rod		*	*	*
G165	Clutch Fixed Plate Lock Nut		*	*	*
G166	Clutch Fixed Plate Spring		*	*	*

Quote Part Number, Name of Part, Model and Year, when Ordering. 4-98 h.p. 1926-27 A.J.S. Motor Cycles.

Part No. DESCRIPTION OF PART.

Clutch Continued.

G163	Clutch Operating Lever...	H591	*	*	*	*	*	*
G164	Hinge Pin with Washer and Cotter for Operating Lever	H592	*	*	*	*	*	*
G165	Clutch Plate Locking Pin and Washer		*	*	*	*	*	*
G166	Clutch Plate Locking Pin Spring		*	*	*	*	*	*
G167	Clutch Plate Pin		*	*	*	*	*	*
G168	Clutch Cap with Bush	H594	*	*	*	*	*	*
G169	Clutch Cap Bush only	H595	*	*	*	*	*	*
	Clutch Cap Pins (as G121-1)	H413	*	*	*	*	*	*

Footstarter.

G171	Footstarter Quadrant only		*	*	*	*	*	*
G172	Footstarter Quadrant Shaft only		*	*	*	*	*	*
G173	Footstarter Crank and Pedal		*	*	*	*	*	*
G174	Footstarter Tube		*	*	*	*	*	*
	Grease Nipple for above (as G54-2)	H180	*	*	*	*	*	*
G175	Footstarter Cotter Pin with Nut and Washer	H529	*	*	*	*	*	*
G176	Footstarter Coil Spring	H542	*	*	*	*	*	*
G177	Fixing Pin for above (3.16 x 1/4 in., 32 Thd)	H543	*	*	*	*	*	*
G178	Footstarter Ratchet Wheel	H538	*	*	*	*	*	*
G179	Footstarter Ratchet Plate	H539	*	*	*	*	*	*
G183	Footstarter Ratchet Spring	H540	*	*	*	*	*	*

Gate Change.

G181	Change Speed Gate only...		*	*	*	*	*	*
G181-1	Change Speed Quadrant...	H545	*	*	*	*	*	*
G182	Pin and Washer Securing Gate to Petrol Tank (1/4 in., 20 Thd., Plated)	H553	*	*	*	*	*	*
G183	Change Speed Lever, less Knob		*	*	*	*	*	*
G183-1	Change Speed Lever, less Knob		*	*	*	*	*	*
G184	Change Speed Lever Knob, with Pin and Washer	H555	*	*	*	*	*	*
G185	Pin and Washer for Knob		*	*	*	*	*	*

Where Part Number is given in brackets this number should be quoted.

Quote Part Number, Name of Part, Model and Year, when Ordering. 4-98 h.p. 1926-27 A.J.S. Motor Cycles.

Part No. DESCRIPTION OF PART.

Gate Change - Continued.

G185-1	Change Speed Lever Knob	H558	*	*	*	*	*	*
G186	Pin for Split End of Change Speed Lever (1/4 x 1/4 in., 20 Thd.)	H603	*	*	*	*	*	*
G186-1	Centre Pin for Change Speed Lever	H562	*	*	*	*	*	*
G186-2	Nut for above...	H564	*	*	*	*	*	*
G186-3	Spring Washer for above	H565	*	*	*	*	*	*
G187	Change Speed Bell Crank Lever		*	*	*	*	*	*
G188	Change Speed Gate Spindle		*	*	*	*	*	*
G189	Change Speed Gate Spindle Tube		*	*	*	*	*	*
G190	Short Change Speed Lever		*	*	*	*	*	*
G191	Bell Crank Lever Spindle		*	*	*	*	*	*
G192	Horizontal Change Speed Rod only		*	*	*	*	*	*
G193	Vertical Change Speed Rod only		*	*	*	*	*	*
G193-1	Vertical Change Speed Rod only	H567	*	*	*	*	*	*
G194	Change Speed Yoke Ends with Pins	H568	*	*	*	*	*	*
G194-1	Pins and Nuts only for above	H569	*	*	*	*	*	*
G195	Change Speed Ball Joint	H570	*	*	*	*	*	*
G195-1	Nut for Ball Joint (1/4 in., 20 Thd.)	H571	*	*	*	*	*	*
G195-2	Spring for Ball Joint	H572	*	*	*	*	*	*

Front Wheel.

G196	Front Wheel complete, with Expanding Brake complete (less Tyre and Tube)		*	*	*	*	*	*
G196-1	Front Wheel complete, with Expanding Brake complete (less Tyre and Tube)		*	*	*	*	*	*
G196-2	Front Wheel complete, with Expanding Brake complete (less Tyre and Tube)		*	*	*	*	*	*
G197	Front Wheel with Hub Shell only		*	*	*	*	*	*
G197-1	Front Wheel with Hub Shell only		*	*	*	*	*	*
G197-2	Front Wheel with Hub Shell only		*	*	*	*	*	*
G198	Front Wheel Rim only		*	*	*	*	*	*
G198-1	Front Wheel Rim only		*	*	*	*	*	*

NOTE * Indicates models for which Part is suitable. For Agent's Use. 4-98 h.p. List No. 1926 MODELS G8 OHV 1927 MODELS H8 OHV H9 SV H10 OHV

			G8	G10	H8	H9	H10
			OHV	OHV	OHV	SV	OHV
			*	*	*	*	*

Quote Part Number, Name of Part, Model, and Year, when Ordering. 4.98 h.p. 1926-27 A.J.S. Motor Cycles.

NOTE * Indicates models for which Part is suitable. For Agent's Use. 1926 MODELS 1927 MODELS H8 H9 H10 OHV SV OHV

Part No.	DESCRIPTION OF PART.	G8	G10	H8	H9	H10
		OHV	OHV	OHV	SV	OHV
G198-2	Front Wheel Rim only	*	*	*	*	*
G199	Spokes with Nipples, short (single spoke) (per set 20)	*	*	*	*	*
G199-1	Spokes with Nipples, short (single spoke) (per set 20)	*	*	*	*	*
G199-2	Spokes with Nipples, short (single spoke) (per set 20)	*	*	*	*	*
G200	Spokes with Nipples, long (single spoke) (per set 20)	*	*	*	*	*
G200-1	Spokes with Nipples, long (single spoke) (per set 20)	*	*	*	*	*
G200-2	Spokes with Nipples, long (single spoke) (per set 20)	*	*	*	*	*
G200-3	Nipples for Spokes (single Nipple) (per set 40)	*	*	*	*	*
G201	Wheel Bearings (5 to in.) (per set 22)	*	*	*	*	*
G202	Solid Spindle	*	*	*	*	*
G203	Hub Shell only with Fixed Cup and Lubricator	*	*	*	*	*
G204	Fixed Cup (same as rear)	*	*	*	*	*
G205	Adjustable Cup (same as rear)	*	*	*	*	*
G206	Felt Washer for Adjustable Cup	*	*	*	*	*
G207	Hub Lock Ring (same as rear)	*	*	*	*	*
Expanding Front Brake Parts.						
G208	Brake Shoes with Linings and Springs fitted	*	*	*	*	*
G208-1	Top Front Brake Shoe with Lining	*	*	*	*	*
G208-2	Bottom Front Brake Shoe with Lining	*	*	*	*	*
G209	Brake Linings with Screws (rivets not used)	*	*	*	*	*
G209-1	Screws for Brake Linings (set)	*	*	*	*	*
G210	Anchor Plate	*	*	*	*	*
G211	Expander Spindle with Nut and Washer	*	*	*	*	*
G212	Expander Spindle Nut (5.16 in., 20Tpd.)	*	*	*	*	*
G213	Expander Spindle Washer (5.16 in. springs)	*	*	*	*	*
G214	Brake Operating Lever	*	*	*	*	*
G215	Operating Lever Return Spring	*	*	*	*	*

Front Wheel—Continued

Quote Part Number, Name of Part, Model, and Year when Ordering. 4.98 h.p. 1926-27 A.J.S. Motor Cycles.

NOTE * Indicates models for which Part is suitable. For Agent's Use. 1926 MODELS 1927 MODELS H8 H9 H10 OHV SV OHV

Part No.	DESCRIPTION OF PART.	G8	G10	H8	H9	H10
		OHV	OHV	OHV	SV	OHV
Expanding Front Brake Parts						
H052	Anchor Plate Pin (7/16 x 16 in., 26 Tpd.) (Continued.)	*	*	*	*	*
H053	Felt Washer (not now used)	*	*	*	*	*
H050	Brake Shoe Springs	*	*	*	*	*
H019	Hub Lubricator	*	*	*	*	*
G220	Spindle Lock Nuts (1/2 in., 24 Tpd., Blind)	*	*	*	*	*
Rear Wheel.						
G221	Rear Wheel, complete with Sprocket and Sleeve Bolts only (less Tyre)	*	*	*	*	*
G221-1	Rear Wheel, complete with Sprocket and Bolts only (less Tyre)	*	*	*	*	*
G221-2	Rear Wheel, complete with Sprocket and Sleeve Bolts only (less Tyre)	*	*	*	*	*
G222	Rear Wheel, fitted with Hub Shell only	*	*	*	*	*
G222-1	Rear Wheel, fitted with Hub Shell only	*	*	*	*	*
G222-2	Rear Wheel, fitted with Hub Shell only	*	*	*	*	*
G223	Rear Hub Shell only, with Fixed Cup and Lubricator	*	*	*	*	*
G223-1	Rear Hub Shell only, with Fixed Cup and Lubricator	*	*	*	*	*
	Hub Lubricator (as G219)	*	*	*	*	*
	Rear Wheel Rim (as G198)	*	*	*	*	*
	Rear Wheel Rim (as G198-1)	*	*	*	*	*
	Rear Wheel Rim (as G198-2)	*	*	*	*	*
G225	Spokes. Set 40. Single Spoke	*	*	*	*	*
G225-1	Spokes. Set 40. Single Spoke	*	*	*	*	*
G225-2	Spokes. Set 40. Single Spoke	*	*	*	*	*
G225-3	Nipples for Spokes. Set 40. Single Nipple	*	*	*	*	*
	Wheel Bearings. (5.16 in.) Set 22 (as G201)	*	*	*	*	*
G227	Solid Centre Spindle	*	*	*	*	*
G227-1	Rear Spindle only	*	*	*	*	*
G227-2	Nuts for above (1/2 in., 24 Tpd.) each	*	*	*	*	*
G228	Hub Hollow Spindle	*	*	*	*	*

Where Part Number is given in brackets this number should be quoted.

Quote Part Number, Name of Part, Model, and Year, when Ordering. 4.98 h.p. 1926-27 A.J.S. Motor Cycles.

NOTE * Indicates models for which Part is suitable. For Agent's Use. 1926 MODELS 1927 MODELS

3-49 h.p. List No. G8 OHV G9 OHV H8 OHV H9 OHV H10 OHV

Part No.	DESCRIPTION OF PART.	G8	G9	H8	H9	H10
Rear Wheel—Continued.						
	Fixed Cup (as G204) ..	*	*	*	*	*
	Adjustable Cup (as G205) ..	*	*	*	*	*
	Hub Lock Ring (as G207) ..	*	*	*	*	*
Rear Brake Drum & Expanding Brake Parts.						
G232	Brake Shoes, with Linings and Screws (pair) ..	*	*	*	*	*
G232-1	Top Half Brake Shoe, with Lining ..	*	*	*	*	*
G232-2	Bottom Half Brake Shoe, with Lining ..	*	*	*	*	*
G233	Brake Linings, with Screws .. (set) ..	*	*	*	*	*
	Screws for Brake Linings (as G209-1) ..	*	*	*	*	*
G234	Anchor Plate ..	*	*	*	*	*
G235	Expander Spindle, with Nut and Washer ..	*	*	*	*	*
G236	Brake Operating Lever ..	*	*	*	*	*
	Nut for Expander Spindle (as G58) ..	*	*	*	*	*
G238	Washer for Expander Spindle ..	*	*	*	*	*
G239	Anchor Plate Pin (4 x 1/4 in., 24Thd.) ..	*	*	*	*	*
G240	Operating Lever Return Spring ..	*	*	*	*	*
G241	Brake Drum, with Centre Fitted ..	*	*	*	*	*
G241-1	Brake Drum only ..	*	*	*	*	*
G242	Brake Drum Centre only ..	*	*	*	*	*
	Screws for above (as G121-1) ..	*	*	*	*	*
G242-2	Bolts for Rear Sprocket (3/8 x 13 16, 26Thd.) ..	*	*	*	*	*
	Nuts only for above (3/8 in., 26Thd.) (as G58) ..	*	*	*	*	*
G243	Driving Studs, screwed ..	*	*	*	*	*
G244	Driving Studs, plain ..	*	*	*	*	*
G245	Drum Centre Dummy Spindle only ..	*	*	*	*	*
G246	Nut only for Dummy Spindle (3/8 in., 24Thd., thin) ..	*	*	*	*	*
G247	Inside Distance Piece, plain ..	*	*	*	*	*

Where Part Number is given in brackets this number should be quoted.

Quote Part Number, Name of Part, Model, and Year, when Ordering. 4.98 h.p. 1926-27 A.J.S. Motor Cycles.

NOTE * Indicates models for which Part is suitable. For Agent's Use. 1926 MODELS 1927 MODELS

3-49 h.p. List No. G8 OHV G9 OHV H8 OHV H9 OHV H10 OHV

Part No.	DESCRIPTION OF PART.	G8	G9	H8	H9	H10
Rear Brake Drum & Expanding Brake Parts—Continued.						
G248	Outside Distance Piece, Shaped ..	*	*	*	*	*
G249	Distance Piece Washer ..	*	*	*	*	*
G250	Sleeve Bolts .. each ..	*	*	*	*	*
	Spindle Lock Nuts (3/4 in., 24Thd., blind) (as G220) ..	*	*	*	*	*
G252	Expander Spindle Lubricator (Grease Nipple) ..	*	*	*	*	*
Footrests.						
G253	Footrests, complete, with Brake Pedal, Pedal Plates, and Footrest Plates ..	*	*	*	*	*
G253-1	Footrests, complete with Brake Pedals, Spindle and Bracket ..	*	*	*	*	*
G254	Footrest Rod, with Nuts and Washers ..	*	*	*	*	*
G254-1	Footrest Rod, with Nuts and Washers ..	*	*	*	*	*
G254-2	Footrest Rod Nuts .. each ..	*	*	*	*	*
G254-3	Washers for above .. each ..	*	*	*	*	*
G255	Footrest Distance Tube, centre ..	*	*	*	*	*
G256	Footrest Distance Tube (outside right hand) ..	*	*	*	*	*
G257	Footrest Distance Tube (outside left hand) short) ..	*	*	*	*	*
G258	Footrest Distance Tube (outside left hand) long) ..	*	*	*	*	*
G259	Footrest Plate (right hand) ..	*	*	*	*	*
G260	Inside Brake Pedal Plate ..	*	*	*	*	*
G261	Outside Brake Pedal Plate ..	*	*	*	*	*
G262	Footrest Support Bracket ..	*	*	*	*	*
G262-1	Fixing Plate for above ..	*	*	*	*	*
	Pins for above (as G54) ..	*	*	*	*	*
G263	Not now used ..	*	*	*	*	*
G264	Not now used ..	*	*	*	*	*
G265	Rear Brake Pedal only ..	*	*	*	*	*
G265-1	Rear Brake Pedal only (left hand) ..	*	*	*	*	*
G265-2	Oil Pump Pedal (right hand) ..	*	*	*	*	*

Where Part Number is given in brackets this number should be quoted.

Quote Part Number, Name of Part, Model, and Year, when Ordering. 4-98 h.p. 1926-27 A.J.S. Motor Cycles.

NOTE * Indicates models for which Part is suitable.

For Agent's Use. 1926 MODELS: C8, C10, OHV, OHV SV. 1927 MODEL: H8, H9, OHV, SV, OHV.

Part No. DESCRIPTION OF PART.

Footrests—Continued.

G266	Rear Brake Pedal Spindle and Nut	*	*	*	*	*	*	*	*
G266-1	Nut only for above (3 in., 20 Thd.)	*	*	*	*	*	*	*	*
G266-2	Rear Brake and Oil Pump Pedal Spindle (less Nuts)	*	*	*	*	*	*	*	*
G266-4	Nuts only for above (as G58)	*	*	*	*	*	*	*	*
G267	Washers only for above (3/8 in., Plain)	*	*	*	*	*	*	*	*
G268	Footrest Rubbers	*	*	*	*	*	*	*	*
G269	Outer Washer for Footrest	*	*	*	*	*	*	*	*
G270	Inner Washer for Footrest	*	*	*	*	*	*	*	*
G271	Pin for Outer Washer (5/16 x 3/8 in., 20 Thd.)	*	*	*	*	*	*	*	*
G271-1	Footrest Arms only	*	*	*	*	*	*	*	*
G272	Footrest Arms only	*	*	*	*	*	*	*	*
G272-1	Brake Operating Rod only	*	*	*	*	*	*	*	*
G273	Brake Operating Rod only	*	*	*	*	*	*	*	*
G273-1	Yoke ends for above, with Pins and Cotters	*	*	*	*	*	*	*	*
G274	Pins and Cotters only for Yoke Ends	*	*	*	*	*	*	*	*
G274-1	Front Mudguard, with Splasher (less Stays)	*	*	*	*	*	*	*	*
G275	Front Mudguard (less Stays)	*	*	*	*	*	*	*	*
G276	Front Mudguard Splasher	*	*	*	*	*	*	*	*
G276-1	Pins, Nuts and Washers for Splasher (1 x 1/2 in., 20 Thd.) (as G185)	*	*	*	*	*	*	*	*
G276-2	Front Mudguard Stays	*	*	*	*	*	*	*	*
G276-4	Front Mudguard Stay	*	*	*	*	*	*	*	*
G276-5	Pins, Nuts and Washers for Mudguard Stays (5/16 x 1 in., 20 Thd.)	*	*	*	*	*	*	*	*
G277	Bolt, for fixing guard to Forks (as G186)	*	*	*	*	*	*	*	*
G277-1	Domed Nut for above	*	*	*	*	*	*	*	*
G277-2	Washer for above	*	*	*	*	*	*	*	*
G277-3	Front Number Plate	*	*	*	*	*	*	*	*

Where Part Number is given in brackets this number should be quoted.

Quote Part Number, Name of Part, Model, and Year, when Ordering. 4-98 h.p. 1926-27 A.J.S. Motor Cycles.

NOTE * Indicates models for which Part is suitable.

For Agent's Use. 1926 MODELS: C8, C10, OHV, OHV SV. 1927 MODEL: H8, H9, OHV, SV, OHV.

Part No. DESCRIPTION OF PART.

Front Mudguard
(continued)

G278	Number Plate Clips, with Pins and Nuts, pair.	*	*	*	*	*	*	*	*
G278-1	Pins and Nuts only for above (3/16 x 3/16 in., 24 Thd.)	*	*	*	*	*	*	*	*
G278-2	Bridge Plates for Front Mudguard, pair.	*	*	*	*	*	*	*	*
G279	Pins, Nuts and Washers for above (as G95)	*	*	*	*	*	*	*	*
G279-1	Rear Mudguard only	*	*	*	*	*	*	*	*
G279-2	Rear Mudguard only	*	*	*	*	*	*	*	*
G279-3	Rear Mudguard Stays	*	*	*	*	*	*	*	*
G279-4	Pins, Nuts and Washers for above (as G95)	*	*	*	*	*	*	*	*
G280	Bridge Clip, with Pins and Nuts for Rear Mudguard	*	*	*	*	*	*	*	*
G280-1	Pins and Nuts for Bridge Clips (as G186)	*	*	*	*	*	*	*	*
G281	Rear Number Plate	*	*	*	*	*	*	*	*
G281-1	Rear Number Plate (Electric)	*	*	*	*	*	*	*	*
G281-2	Pins, Nuts and Washers, for Rear Number Plate (as G186)	*	*	*	*	*	*	*	*
G281-3	Rear Carrier complete with Strap	*	*	*	*	*	*	*	*
G282	Pins and Washers for fixing Rear Carrier to Frame (as G62)	*	*	*	*	*	*	*	*
G283	Special Tubular Stay to replace Standard Carrier	*	*	*	*	*	*	*	*
G283-1	Bridge Piece only for Rear Guard, for use with above	*	*	*	*	*	*	*	*
G284	Pannier Tool Cases, with fittings.	*	*	*	*	*	*	*	*
G285	Fittings for Pannier Tool Case on Carrier per set	*	*	*	*	*	*	*	*
G285-1	Fittings for Pannier Tool Case on Tubular Stay	*	*	*	*	*	*	*	*
G286	Chaincase & Chainguard	*	*	*	*	*	*	*	*
G286-1	Chaincase complete with fittings	*	*	*	*	*	*	*	*
G286-2	Chainguard complete with fittings	*	*	*	*	*	*	*	*
G286-3	Chaincase Distance Spool	*	*	*	*	*	*	*	*
G286-4	Chaincase Distance Pin and Nut (3 x 3/16 in., 20 Thd.)	*	*	*	*	*	*	*	*
G286-5	Nut for above (3/16 in., 20 Thd.) (as G58)	*	*	*	*	*	*	*	*

Where Part Number is given in brackets this number should be quoted.

Quote Part Number, Name of Part, Model, and Year, when Ordering. 4.98 h p. 1926-27 A.J.S. Motor Cycles.

NOTE * Indicates models for which Part is suitable. For Agent's Use. 1926 MODELS 1927 MODELS

Chaincase & Chainguard
(continued).

Part No.	DESCRIPTION OF PART.	G8 OHV	G10 OHV	H8 OHV	H9 OHV	H10 SV	H110 OHV
G286-2	Washer for Chaincase Distance Pin and Nut, plain	*	*	*	*	*	*
G287	Rear Portion of Chaincase	*	*	*	*	*	*
G287-1	Rear Portion of Chaincase	*	*	*	*	*	*
G287-2	Pins and Washers for Rear Portion of Chaincase (4 x 1/2 In., 20Tud)	*	*	*	*	*	*
G287A	Top Half Front Portion of Chaincase	*	*	*	*	*	*
G288	Clutch and Kickstart Inspection Cover	*	*	*	*	*	*
G283-1	Pins for fixing above	*	*	*	*	*	*
G285-2	Front Portion of Chaincase	*	*	*	*	*	*
G288A	Bottom Half of Front Portion of Chaincase	*	*	*	*	*	*
G288A-1	Pin and Nut for Fixing Top and Bottom Halves of Chaincase (4 in.)	*	*	*	*	*	*
G289	Chaincase Oil Cap	*	*	*	*	*	*

Tank & Fittings.

G290	Petrol Tank without Fittings	*	*	*	*	*	*
G290-1	Petrol Tank without Fittings	*	*	*	*	*	*
G290A	Not used	*	*	*	*	*	*
	Pin for Tank (as G180)	*	*	*	*	*	*
	Spring Washer for above (as G276-5)	*	*	*	*	*	*
G290B-2	Felt Pads for Tank	*	*	*	*	*	*
G291	Knee Grips	*	*	*	*	*	*
G291-1	Screws for Kneet Grips	*	*	*	*	*	*
G291-2	Oval Flange for Knee Grips	*	*	*	*	*	*
G292	Petrol or Oil Filler Caps	*	*	*	*	*	*
G292-1	Anti-Splasher Disc for above	*	*	*	*	*	*
G292-2	Leather Washer for above	*	*	*	*	*	*
G293	Petrol Tap (Non-Filter Type)	*	*	*	*	*	*
G293-1	Oil Tap	*	*	*	*	*	*
G293-2	Injection Tap, with Pipe and Nut	*	*	*	*	*	*

Where Part Number is given in brackets this number should be quoted.

Quote Part Number, Name of Part, Model, and Year, when Ordering. 4.98 h p. 1926-27 A.J.S. Motor Cycles.

NOTE * Indicates models for which Part is suitable. For Agent's Use. 1926 MODELS 1927 MODELS

Tank & Fittings
(Continued).

Part No.	DESCRIPTION OF PART.	G8 OHV	G10 OHV	H8 OHV	H9 SV	H10 OHV
G293-3	Pipe only for Injection Tap	*	*	*	*	*
G293-4	Nut only for Injection Tap	*	*	*	*	*
G294	C. and A. Washers for Taps (as G225-6)	*	*	*	*	*
G294-1	Petrol Pipe, with Unions	*	*	*	*	*
G294-2	Nipple and Nut for Petrol Pipe, Tank end	*	*	*	*	*
G294-3	Nipple and Nut for Petrol Pipe, Carburettor end	*	*	*	*	*
G295	Oil Pipe for Hand Pump	*	*	*	*	*
G295-1	Nipple and Nut for Oil Pipe	*	*	*	*	*
G296	Mechanical Pump Delivery Pipe	*	*	*	*	*
G297	Mechanical Pump Suction Pipe	*	*	*	*	*
G297-1	(Oil Pipe Connections in Tank and Crankcase each	*	*	*	*	*
	C. and A. Washers for above (as G22-6)	*	*	*	*	*

Saddles & Inflator.

G298	Terry's Spring Seat Saddle, No. 2	*	*	*	*	*
G298A	Terry's Spring Seat Saddle, No. 1	*	*	*	*	*
G298A-1	Saddle Clip for Seat Pillar	*	*	*	*	*
G298A-2	Serrated Side Plates for above each	*	*	*	*	*
G298A-3	Square Centre Bolt only	*	*	*	*	*
G298A-4	Nut for above	*	*	*	*	*
G298A-5	Plain Washer for above	*	*	*	*	*
G299	Tyre Inflator (Apex)	*	*	*	*	*
G300	Cork Washers for Petrol and Oil Taps doz.	*	*	*	*	*

Legshields & Fittings.

G301	Legshields, complete with Fittings	*	*	*	*	*
G301-1	Legshield only, Right-hand	*	*	*	*	*
G301-2	Legshield only, Left-hand	*	*	*	*	*

Where Part Number is given in brackets this number should be quoted.

Quote Part Number, Name of Part, Model and Year, when Ordering. 4.98 h.p. 1926-27 A.J.S. Motor Cycles.

NOTE * Indicates models for which Part is suitable. For Agent's Use. 1926 MODELS 1927 MODELS

Part No.	DESCRIPTION OF PART.	G8 OHV	G10 OHV	H8 OHV	H9 SV	H10 OHV
G301-3	Support Rod, complete with Frame Clip and Nut	*	*	*	*	*
G301-4	Frame Half Clip only	*	*	*	*	*
G301-5	Nut only for Frame Clip	*	*	*	*	*
G301-6	Clip complete for fixing Legshield to Support Rod	*	*	*	*	*
G301-7	Aluminium Portion only of above	*	*	*	*	*
G301-8	Outside Latch only	*	*	*	*	*
G301-9	Pins only	*	*	*	*	*
G301-10	Washers only for above	*	*	*	*	*
G301-11	Hexagon Nut	*	*	*	*	*
G301-12	Wing Nut	*	*	*	*	*
Spring Forks.						
G302	Front Spring Forks complete	*	*	*	*	*
G303	Spring Fork Girder only	*	*	*	*	*
G304	Fork Springs	each	*	*	*	*
G304-1	Bottom Pin, Nut and Washer for Fork Spring (5.16 x 1.7-16 in., 20 Tbd.)	*	*	*	*	*
G305	Steering Crown and Column	*	*	*	*	*
G306	Top Link, plain	*	*	*	*	*
G307	Top Link, tapped	*	*	*	*	*
G308	Bottom Link, plain	*	*	*	*	*
G309	Bottom Link, tapped	*	*	*	*	*
G310	Top Spindles, less Nuts	each	*	*	*	*
G311	Bottom Spindles, less Nuts	each	*	*	*	*
G312	Spindle Lock Nuts (7/16 in., 26 Tbd.) plated	each	*	*	*	*
G313	Friction Discs	pair	*	*	*	*
G314	Spring Washer for Friction Discs		*	*	*	*
G315	Grease Nipple for Forks (as G34-2)		*	*	*	*
	Ball Head Race, top or bottom	*	*	*	*	*

Where Part Number is given in bracket; this number should be quoted.

Quote Part Number, Name of Part, Model and Year, when Ordering. 4.98 h.p. 1926-27 A.J.S. Motor Cycles.

NOTE * Indicates models for which Part is suitable. For Agent's Use. 1926 MODELS 1927 MODELS

Part No.	DESCRIPTION OF PART.	G8 OHV	G10 OHV	H8 OHV	H9 SV	H10 OHV
Spring Forks - Continued.						
G316	Fork Stem Race, Bottom	*	*	*	*	*
G317	Steering Head Lock Nut	*	*	*	*	*
G318	Square Headed Pin and Washer for Fork Spring, top (5.16 x 1.1-16 in.)	*	*	*	*	*
G319	Steel Balls for Head Races. Set 56	*	*	*	*	*
G319-1	Lubricator for Frame Head (1 in.)	*	*	*	*	*
G320	Steering Collar and Race (Race not supplied separately)	*	*	*	*	*
G321	Steering Head Clip	*	*	*	*	*
G322	Bolt and Nut for Head Clip (5/8 x 1 1/2 in., 20 Tbd.)	*	*	*	*	*
Frame.						
G323	Seat Pillar	*	*	*	*	*
G324	Seat Pillar Bolt, with Nut and Washer (1/2 x 3/8 in., 24 Tbd.)	*	*	*	*	*
G324-1	Expander Bolt for Seat Pillar	*	*	*	*	*
G324-2	Expander Bolt Cone	*	*	*	*	*
G325	Nut and Washer only for above (as G227-2)	*	*	*	*	*
G325-1	Frame complete	*	*	*	*	*
G326	Adjusting Pin and Nut for Rear Wheel	*	*	*	*	*
Front and Rear Stands.						
G327	Front Wheel Stand only	*	*	*	*	*
G328	Front Stand Support Bolt and Nuts	*	*	*	*	*
G329	Nuts only for above (as G212)	*	*	*	*	*
G330	Front Stand Bolts and Nuts (as G276-2)	*	*	*	*	*
G331	Nuts only for above (as G212)	*	*	*	*	*
G332	Rear Wheel Stand only	*	*	*	*	*
G333	Rear Stand Clip, complete (Inner & Outer Straps)	*	*	*	*	*
G334	Rear Stand Clip (Outer Strap only)	*	*	*	*	*
G335	Rear Stand Clip (Inner Strap only)	*	*	*	*	*
G335-1	Rear Stand Clip, complete (Racing Type)	*	*	*	*	*

Where Part Number is given in brackets this number should be quoted.

Quote Part Number, Name of Part, Model, and Year, when Ordering. 4.98 h.p. 1926-27 A.J.S. Motor Cycles.

NOTE * Indicates models for which Part is suitable.

Part No.	DESCRIPTION OF PART.	1926 MODELS			1927 MODELS		
		G8 OHV	G70 OHV	H4 OHV	H3 OHV	H9 SV	H10 OHV
Front and Rear Stands (continued).							
G333-2	Pin, Nut and Washer, for Rear Stand Clip (as G287-2)	*	*	*	*	*	*
G333-3	Spiral Spring for Rear Stand Clip ..	*	*	*	*	*	*
G333-4	Nut for Spiral Spring Stud (3 16in., 20Thd.) ..	*	*	*	*	*	*
G334	Plain Washer for above ..	*	*	*	*	*	*
G334-1	Rear Stand Pin and Nut (9 16 x 1-3 16in., 20 Thd.) ..	*	*	*	*	*	*
G334-1	Nut only for above (9 16 in., 20 Thd.) ..	*	*	*	*	*	*
Handlebars.							
G335	Handlebars only, less Rubber Grips	*	*	*	*	*	*
G335-1	Handlebars only, less Rubber Grips	*	*	*	*	*	*
G335-2	Handlebars only, less Rubber Grips	*	*	*	*	*	*
G335	Handlebar Expander Bolt with Cone	*	*	*	*	*	*
G335-1	Cone only for above ..	*	*	*	*	*	*
G337	Rear Wheel Setting Piece, with Clip	*	*	*	*	*	*
G337-1	Clip only for above ..	*	*	*	*	*	*
G337-2	Rear Wheel Setting Piece only ..	*	*	*	*	*	*
G337-3	Rear Wheel Setting Piece only ..	*	*	*	*	*	*
G338	Not used ..						
Magneto.							
G339	Magneto only, less Sprocket II.T. Wire, &c. (Type K.L.L.)	*	*	*	*	*	*
G339-1	Magneto Armature, with Bearings	*	*	*	*	*	*
G339-2	Slip Ring only ..	*	*	*	*	*	*
G340	Magneto Sprocket ..	*	*	*	*	*	*
G341	Magneto Sprocket Sleeve ..	*	*	*	*	*	*
G342	Magneto Sprocket Peg Washer ..	*	*	*	*	*	*
G343	Magneto Sprocket Sleeve Lock Nut ..	*	*	*	*	*	*
G343-1	Cover for Contact Breaker ..	*	*	*	*	*	*
G343-2	Stud and Retaining Spring for Contact Breaker Cover	*	*	*	*	*	*
G343-3	Contact Breaker complete ..	*	*	*	*	*	*

Where Part Number is given in brackets this number should be quoted.

Quote Part Number, Name of Part, Model, and Year, when Ordering. 4.98-h.p. 1926-27 A.J.S. Motor Cycles.

NOTE * Indicates models for which Part is suitable.

Part No.	DESCRIPTION OF PART.	1926 MODELS			1927 MODELS		
		G8 OHV	G70 OHV	H4 OHV	H3 OHV	H9 SV	H10 OHV
Magneto—Continued.							
G343-4	Rocker Arm, with Platinum Point fitted ..	*	*	*	*	*	*
G343-5	Long Platinum Point, with Lock Nut ..	*	*	*	*	*	*
G343-6	Rocker Arm Return Spring ..	*	*	*	*	*	*
G343-7	Screw for above ..	*	*	*	*	*	*
G343-8	Tapered Centre Screw for Contact Breaker ..	*	*	*	*	*	*
G343-9	Earth Carbon Brush and Spring ..	*	*	*	*	*	*
G343-10	Cam Ring only ..	*	*	*	*	*	*
G343-11	Carbon Brush Holder only ..	*	*	*	*	*	*
G343-12	H.T. Carbon Brush, with Spring ..	*	*	*	*	*	*
G343-13	Stud and Retaining Spring for Brush Holder ..	*	*	*	*	*	*
G343-14	Bowlken Control Slide for Contact Breaker ..	*	*	*	*	*	*
G343-15	Return Spring for above ..	*	*	*	*	*	*
G343-16	Top Plate only for Control Slide ..	*	*	*	*	*	*
G343-17	Countersunk Screw for Top Plate ..	*	*	*	*	*	*
G343-18	Bowden Adjuster for Control Slide ..	*	*	*	*	*	*
G343-19	Retaining Screw at Base of Control Slide ..	*	*	*	*	*	*
G344	Magneto Shield ..	*	*	*	*	*	*
G345	Pin Nut and Washer for fixing Magneto Shield (as G95) ..	*	*	*	*	*	*
G346	High Tension Wire, with Terminal ..	*	*	*	*	*	*
G346-1	Spark Plug, Lodge H.I. ..	*	*	*	*	*	*
G347	C. and A. Washer for above ..	*	*	*	*	*	*
* For Magdyno and fittings: see page 45.							
Exhaust System.							
G347-1	Exhaust System, complete with Lock Ring and Clips	*	*	*	*	*	*
G347-2	Exhaust System, complete with Lock Ring and Clips	*	*	*	*	*	*
G347-3	Exhaust System, complete with Lock Ring and Clips	*	*	*	*	*	*
G347-4	Exhaust System, complete with Lock Ring and Clips	*	*	*	*	*	*

Where Part Number is given in brackets this number should be quoted.

Quote Part Number, Name of Part, Model, and Year, when Ordering. 4.98 h.p. 1926-27 A.J.S. Motor Cycles.

Part No.	DESCRIPTION OF PART.	For Agent's Use		1026 MODELS		1927 MODELS	
		4.9 h.p. List No.	G8 OHV	G10 OHV	H8 OHV	H9 SV	H10 OHV
Exhaust System Continued.							
G348	Exhaust Pipe only		*				
G348-1	Exhaust Pipe only		*				
G348-2	Exhaust Pipe only						
G348-3	Exhaust Pipe only				*		
G348-4	Exhaust Pipe only					*	
G349	Lock Ring for Exhaust Pipe						
G349-1	Lock Ring for Exhaust Pipe	H1251	*			*	
G349-2	Lock Ring for Exhaust Pipe (Finned) Interchangeable with G349-1	H1262		*			
*G350	Expansion Chamber only		*			*	
*G359-1	Expansion Chamber only			*			
G350-2	Expansion Chamber only						
G351	Fish Tail for Expansion Chamber (old type)						
G351-1	Tail Pipe for Expansion Chamber		*			*	
G351-2	Tail Pipe for Expansion Chamber		*			*	
G351-3	Tail Pipe for Expansion Chamber						
G351-4	Front Extension Pipe only	H1225	*		*	*	
G352	Expansion Chamber Clip, front	H1230	*		*	*	
G352-1	Expansion Chamber Clip, front	H1232	*		*	*	
G352-2	Expansion Chamber Clip, front		*		*	*	
G353	Expansion Chamber Clip, rear		*		*	*	
G353-1	Expansion Chamber Clip, rear		*		*	*	
G354	Pins, Nuts and Washers for Expansion Chamber Clips (as G270)	H1537	*		*	*	
G355	Frame Clip only for Supporting Strap		*		*	*	
G355	Pin, Nut and Washer for above (as G276)	H1537	*		*	*	
G356	Supporting Strap only		*		*	*	
G356	Extension Pipe, with Fish Tail and Clip, &c., to convert to Straight-through Exhaust supplied. 1927 type now fitted	H1268	*		*	*	

Where Part Number is given in brackets this number should be quoted.

Quote Part Number, Name of Part, Model, and Year, when Ordering. 4.98 h.p. 1926-27 A.J.S. Motor Cycles.

Part No.	DESCRIPTION OF PART.	For Agent's Use		1026 MODELS		1927 MODELS	
		4.9 h.p. List No.	G8 OHV	G10 OHV	H8 OHV	H9 SV	H10 OHV
Exhaust System							
G355-1	Extension Pipe, with Fishtail and Clip to convert to "Straight-through" Exhaust	H1270	*		*	*	
G355-2	Fishtail only for above	H1274	*		*	*	
G355-3	Fishtail only for above	H1276	*		*	*	
G355-4	Straight-through Extension Pipe only	H1271	*		*	*	
G355-5	Straight-through Extension Pipe only	H1273	*		*	*	
G355-6	Long Clip for Fishtail	H1277	*		*	*	
G355-7	Long Clip for Fishtail	H1278	*		*	*	
	Pins, Nuts and Washers for above (as G270)	H1537	*		*	*	
Driving Chains.							
G357	Front Driving Chain		*		*	*	
G357-1	Front Driving Chain		*		*	*	
G358	Rear Driving Chain		*		*	*	
G358-1	Rear Driving Chain		*		*	*	
G359	Magneto Driving Chain		*		*	*	
G359-1	Magneto Driving Chain		*		*	*	
G360	Driving Chain Two Link Piece		*		*	*	
G360-1	Driving Chain Two Link Piece	H1293	*		*	*	
G361	Driving Chain Spring Link		*		*	*	
G361-1	Driving Chain Spring Link	H1288	*		*	*	
G362	Spring Clip only for Spring Link		*		*	*	
G362-1	Spring Clip only for Spring Link	H1289	*		*	*	
G363	Magneto Chain Two Link Piece	H1294	*		*	*	
G364	Magneto Chain Spring Link	H1290	*		*	*	
G364-1	Spring Clip for Magnet Chain Spring Link	H1291	*		*	*	
G365	Chain Rivet Extractor (Pennant)	H1664	*		*	*	

Carburetter (Binks')

When ordering Spares for above it is absolutely necessary to quote actual year and model of machine and whether top or bottom feed type of Carburetter. This is necessary owing to the frequent changes that have been made in the design of Binks' Carburetter.

Where Part Number is given in brackets this number should be quoted.

Quote Part Number, Name of Part, Model, and Year, when Ordering. 4.98 h.p. 1926-27 A.J.S. Motor Cycles.

NOTE * Indicates models for which Part is suitable.

For Agent's Use. 3.49 h.p. Listing. 1926 MODELS G8 OHV G10 OHV 1927 MODELS H8 OHV H9 SV OHV

Carburettor (Binks')
(Continued.)

Part No.	DESCRIPTION OF PART.	G8 OHV	G10 OHV	H8 OHV	H9 SV OHV
G366	Binks' Two Jet Carburettor, complete with Air Lever and Cables, suitable for Twist Grip Control				
G366-1	Carburettor Body Jet Seat and Choke				
G367	Throttle				
G368	Throttle Spring				
G369	Air Plunger				
G370	Air Plunger Spring				
G371	Carburettor Body Top Plate				
G372	Spring and Rivet for Top Plate				
G372-1	Holding Attachment for Top Plate				
G373	Cable Adjusting Screw and Nut				
G374	Cylinder Lock Nut for Induction Pipe				
G375	Float Chamber complete				
G376	Float Chamber Lid complete				
G377	Needle only				
G378	Petrol Pipe Nipple, with Nut				
G379	Petrol Pipe Filter and Fibre Washer				
G379-1	Needle Valve Seat and Petrol Connection				
G379-2	Filter Cap Union				
G379-3	Filter Protector				
G380	Lock Spring and Rivet for Float Chamber Lid				
G381	Float and Bow				
G382	Pilot Jet (state size of Orifice)				
G383	Main Jet (state size of Orifice)				
G384	Jet Key				
G385	Washer for Float Chamber				
G385-1	Float Chamber Holding Screw				
G385-2	Washer for above				

Quote Part Number, Name of Part, Model, and Year, when Ordering. 4.98 h.p. 1926-27 A.J.S. Motor Cycles.

NOTE * Indicates models for which Part is suitable.

For Agent's Use. 3.49 h.p. Listing. 1926 MODELS G8 OHV G10 OHV 1927 MODELS H8 OHV H9 SV OHV

Carburettor (Binks')
(Continued.)

Part No.	DESCRIPTION OF PART.	G8 OHV	G10 OHV	H8 OHV	H9 SV OHV
G386	Air Lever Base only				
G387	Air Lever only				
G388	Bottom Clamp				
G389	Clamp Screws				
G389-1	Top Plate				
G389-2	Centre Pin				
G389-3	Spring				
NOTE—For Twist Grip Parts, see pages 40 & 41					
Control Levers & Cables.					
G390	Carburettor Air Control Lever and Cable	*	*	*	*
G391	Carburettor Air Control Lever, complete, less Cable	*	*	*	*
G392	Carburettor Air Control Cable complete	*	*	*	*
G393	Carburettor Throttle Control Cable complete	*	*	*	*
G393-1	Carburettor Throttle Control Cable complete	*	*	*	*
G394	Clutch Control Lever, with Clip and Cable	*	*	*	*
G394-1	Clutch Control Lever, complete less Cable	H1034	*	*	*
G395	Clutch Control Lever only less Clip	H1025	*	*	*
G395-1	Large Headed Pin for Clutch Lever	H1039	*	*	*
G395-2	"D" Washer for above	H1040	*	*	*
G396	Clutch Control Base, with Clip and Screws	H1036	*	*	*
G396-1	Half Clip only for above	H1037	*	*	*
G396-2	Clamp Screws for above	H1038	*	*	*
G397	Clutch Control Cable complete	H1125	*	*	*
G397-1	Clutch Cable Outer Casing	H1129	*	*	*
G397-2	Clutch Cable Inner Wire	H1127	*	*	*
G397-3	Bowden Adjuster for above	H1044	*	*	*
G397-4	Nipple for Clutch Inner Wire	H1130	*	*	*
G398	Front Brake Control Lever, with Cable		*	*	*

Quote Part Number, Name of Part, Model, and Year when Ordering. 4.98 h p. 1926-27 A.J.S. Motor Cycles.

NOTE * Indicates models for which Part is suitable. For Agent's use. 1926 MODELS 1927 MODELS

Part No.	DESCRIPTION OF PART.	G8 3-49 h.p. List No.	G10 OHV	H8 OHV	H9 SV	H10 OHV
H110-8	Front Brake Control Lever, without Cable	*	*	*	*	*
H1029	Inverted Lever only	*	*	*	*	*
H1030	Pin and Nut for above	*	*	*	*	*
H1031	Control Body only in Handlebar	*	*	*	*	*
H1032	Cable Stop in Handlebar	*	*	*	*	*
H1899	3.16 in. Screws for fixing Controls in Handlebars	*	*	*	*	*
H1119	Front Brake Control Cable only	*	*	*	*	*
H1123	Front Brake Cable Outer Casing	*	*	*	*	*
H1121	Front Brake Cable Inner Wire	*	*	*	*	*
G400-1	Shackles only for Front Brake Cable	*	*	*	*	*
G400-4	Pin and Split Cotter for above	*	*	*	*	*
G400-5	Nipple for Front Brake Inner Wire	*	*	*	*	*
G401	Magneto Control Lever, with Cable	*	*	*	*	*
G402	Magneto Control Lever, less Cable	*	*	*	*	*
G402-1	Base and Clip for above Control	*	*	*	*	*
G402-2	Clip Pin for above	*	*	*	*	*
G402-3	Centre Pin for above	*	*	*	*	*
G402-4	Top Plate	*	*	*	*	*
G402-5	Lever only	*	*	*	*	*
G402-6	Flat Spring Washer	*	*	*	*	*
G402-7	Fibre Friction Washer	*	*	*	*	*
G403	Magneto Cable complete	*	*	*	*	*
G403-1	Magneto Cable Outer Casing only	*	*	*	*	*
G403-2	Magneto Cable Inner Wire only	*	*	*	*	*
G401	Valve Lifter Control Lever, with Cable	*	*	*	*	*
G405	Valve Lifter Control Lever, without Cable (For detail of above see G339-1, etc.)	*	*	*	*	*
G406	Valve Lifter Cable complete	*	*	*	*	*

Control Levers & Cables
(Continued)

G399	Front Brake Control Lever, without Cable	*	*	*	*	*
G399-1	Inverted Lever only	*	*	*	*	*
G399-2	Pin and Nut for above	*	*	*	*	*
G399-3	Control Body only in Handlebar	*	*	*	*	*
G391-4	Cable Stop in Handlebar	*	*	*	*	*
G399-5	3.16 in. Screws for fixing Controls in Handlebars	*	*	*	*	*
G400	Front Brake Control Cable only	*	*	*	*	*
G400-1	Front Brake Cable Outer Casing	*	*	*	*	*
G400-2	Front Brake Cable Inner Wire	*	*	*	*	*
G400-3	Shackles only for Front Brake Cable	*	*	*	*	*
G400-4	Pin and Split Cotter for above	*	*	*	*	*
G400-5	Nipple for Front Brake Inner Wire	*	*	*	*	*
G401	Magneto Control Lever, with Cable	*	*	*	*	*
G402	Magneto Control Lever, less Cable	*	*	*	*	*
G402-1	Base and Clip for above Control	*	*	*	*	*
G402-2	Clip Pin for above	*	*	*	*	*
G402-3	Centre Pin for above	*	*	*	*	*
G402-4	Top Plate	*	*	*	*	*
G402-5	Lever only	*	*	*	*	*
G402-6	Flat Spring Washer	*	*	*	*	*
G402-7	Fibre Friction Washer	*	*	*	*	*
G403	Magneto Cable complete	*	*	*	*	*
G403-1	Magneto Cable Outer Casing only	*	*	*	*	*
G403-2	Magneto Cable Inner Wire only	*	*	*	*	*
G401	Valve Lifter Control Lever, with Cable	*	*	*	*	*
G405	Valve Lifter Control Lever, without Cable (For detail of above see G339-1, etc.)	*	*	*	*	*
G406	Valve Lifter Cable complete	*	*	*	*	*

Quote Part Number, Name of Part, Model, and Year when Ordering. 4.98 h p. 1926-27 A.J.S. Motor Cycles.

NOTE * Indicates models for which Part is suitable. For Agent's use. 1926 MODELS 1927 MODELS

Part No.	DESCRIPTION OF PART.	G8 3-49 h.p. List No.	G10 OHV	H8 OHV	H9 SV	H10 OHV
H1116	Valve Lifter Cable Outer Casing	*	*	*	*	*
H1114	Valve Lifter Cable Inner Wire	*	*	*	*	*
H1117	Valve Lifter Cable Nipple	*	*	*	*	*
G406-1	Combined Air and Magneto Controls (less Cables)	*	*	*	*	*
G406-5	Air Lever only (long)	*	*	*	*	*
G406-6	Magneto Control Lever only (short)	*	*	*	*	*
G406-7	Top Plate	*	*	*	*	*
G406-8	Spring	*	*	*	*	*
G406-9	Friction Washer	*	*	*	*	*
G406-10	Centre Pin	*	*	*	*	*
G406-11	Base only	*	*	*	*	*
G406-12	Base Clamp only	*	*	*	*	*
G406-13	Clamp Screws	*	*	*	*	*
G406-14	Cable complete for Separate Oil Tank Fuel Control	*	*	*	*	*
G406-15	Inner Wire for above	*	*	*	*	*
G406-16	Outer Casing for above	*	*	*	*	*
G406-17	Shackle with Cotter for above	*	*	*	*	*
G407	Tool Roll complete with Tools (Excluding Grease Gun, Valve Extractor and Wheel Setting Gauge)	*	*	*	*	*
G407-1	Tool Roll complete	*	*	*	*	*
G408	Toll Roll only	*	*	*	*	*
G409	Oil Can	*	*	*	*	*
G410	Pliers	*	*	*	*	*
G411	Small Pliers for Gudgeon Pin Ring	*	*	*	*	*
G412	Large Adjustable Spanner	*	*	*	*	*
G413	Large Open Ended Spanner	*	*	*	*	*
G414	Medium Open Ended Spanner	*	*	*	*	*

Control Levers & Cables
(Continued)

G406-1	Valve Lifter Cable Outer Casing	*	*	*	*	*
G406-2	Valve Lifter Cable Inner Wire	*	*	*	*	*
G406-3	Valve Lifter Cable Nipple	*	*	*	*	*
G406-4	Combined Air and Magneto Controls (less Cables)	*	*	*	*	*
G406-5	Air Lever only (long)	*	*	*	*	*
G406-6	Magneto Control Lever only (short)	*	*	*	*	*
G406-7	Top Plate	*	*	*	*	*
G406-8	Spring	*	*	*	*	*
G406-9	Friction Washer	*	*	*	*	*
G406-10	Centre Pin	*	*	*	*	*
G406-11	Base only	*	*	*	*	*
G406-12	Base Clamp only	*	*	*	*	*
G406-13	Clamp Screws	*	*	*	*	*
G406-14	Cable complete for Separate Oil Tank Fuel Control	*	*	*	*	*
G406-15	Inner Wire for above	*	*	*	*	*
G406-16	Outer Casing for above	*	*	*	*	*
G406-17	Shackle with Cotter for above	*	*	*	*	*
G407	Tool Roll complete with Tools (Excluding Grease Gun, Valve Extractor and Wheel Setting Gauge)	*	*	*	*	*
G407-1	Tool Roll complete	*	*	*	*	*
G408	Toll Roll only	*	*	*	*	*
G409	Oil Can	*	*	*	*	*
G410	Pliers	*	*	*	*	*
G411	Small Pliers for Gudgeon Pin Ring	*	*	*	*	*
G412	Large Adjustable Spanner	*	*	*	*	*
G413	Large Open Ended Spanner	*	*	*	*	*
G414	Medium Open Ended Spanner	*	*	*	*	*

Tools.

G407	Tool Roll complete with Tools (Excluding Grease Gun, Valve Extractor and Wheel Setting Gauge)	*	*	*	*	*
G407-1	Tool Roll complete	*	*	*	*	*
G408	Toll Roll only	*	*	*	*	*
G409	Oil Can	*	*	*	*	*
G410	Pliers	*	*	*	*	*
G411	Small Pliers for Gudgeon Pin Ring	*	*	*	*	*
G412	Large Adjustable Spanner	*	*	*	*	*
G413	Large Open Ended Spanner	*	*	*	*	*
G414	Medium Open Ended Spanner	*	*	*	*	*

Quote Part Number, Name of Part, Model, and Year, when Ordering. 4-98 h.p. 1926-27 A.J.S. Motor Cycles.

NOTE * Indicates models for which Part is suitable. For Agent's Use. 1926 MODELS G8 OHV, G10 OHV, G11 SV. 1927 MODELS H8 OHV, H9 SV, H10 OHV.

Part No.	DESCRIPTION OF PART.	G8 OHV	G10 OHV	G11 SV	H8 OHV	H9 SV	H10 OHV
G451-2	Screwed Plug for Ball Valve ..	*	*	*	*	*	*
G451-3	Spring for above ..	*	*	*	*	*	*
G451-4	Pump Tubular Stop ..	*	*	*	*	*	*
G452	Spring Seating and Gauge Holder..	*	*	*	*	*	*
G453	Large Packing Washer ..	*	*	*	*	*	*
G454	Oil Pump Collar Screw ..	*	*	*	*	*	*
Mechanical Oil Pump (NON-SIGHT FEED ONLY).							
G455	Mechanical Pump complete, less Pipes ..	*	*	*	*	*	*
G456	Pump Driving Washer ..	*	*	*	*	*	*
G457	Pump Carrier and Pin ..	*	*	*	*	*	*
G458	Pointer ..	*	*	*	*	*	*
G459	Indicator with Spring ..	*	*	*	*	*	*
G460	Back Cover Bush ..	*	*	*	*	*	*
G461	Oldham Float..	*	*	*	*	*	*
G462	Stroke Eccentric ..	*	*	*	*	*	*
G463	Countersunk Screw for Back Cover ..	*	*	*	*	*	*
G464	Oldham Wheel ..	*	*	*	*	*	*
G465	Adjuster Nut ..	*	*	*	*	*	*
G466	Nut for Locking Pointer ..	*	*	*	*	*	*
G467	Plunger for Stroke Eccentric ..	*	*	*	*	*	*
G468	Washer for above ..	*	*	*	*	*	*
G469	Indicator Cover Nut ..	*	*	*	*	*	*
G470	(as G463) ..	*	*	*	*	*	*
G471	Pump Drum ..	*	*	*	*	*	*
G472	Pump Body only ..	*	*	*	*	*	*
G473	Back Cover only ..	*	*	*	*	*	*
G474	Driving Eccentric ..	*	*	*	*	*	*

When Part Number is given in brackets this number should be quoted.

Quote Part Number, Name of Part, Model, and Year, when Ordering. 4-98 h.p. 1926-27 A.J.S. Motor Cycles.

NOTE * Indicates models for which Part is suitable. For Agent's Use. 1926 MODELS G8 OHV, G10 OHV, G11 SV. 1927 MODELS H8 OHV, H9 SV, H10 OHV.

Part No.	DESCRIPTION OF PART.	G8 OHV	G10 OHV	G11 SV	H8 OHV	H9 SV	H10 OHV
Mechanical Oil Pump (NON-SIGHT FEED ONLY) Continued.							
G475	Indicator Plug ..	*	*	*	*	*	*
G476	(as G463) ..	*	*	*	*	*	*
G476-1	Pin for fixing Pump to Timing Cover (as G121-1)	*	*	*	*	*	*
G476-2	Washer for above (3 16 in.) ..	*	*	*	*	*	*
G476-3	Union for Tank NOTE For Oil Pipes see G26, &c.	*	*	*	*	*	*
Mechanical Oil Pump (SIGHT FEED TYPE ONLY).							
G476-4	Oil Pump complete, without Pipes or Tap (Two-Hole fixing)	*	*	*	*	*	*
G476-5	Oil Pump complete, without Pipes or Tap (Three-Hole fixing)	*	*	*	*	*	*
G476-6	Pump Body (Two-Hole fixing) ..	*	*	*	*	*	*
G476-7	Pump Body (Three-Hole fixing) ..	*	*	*	*	*	*
G476-8	Fibre Washer for Control Spindle ..	*	*	*	*	*	*
G476-9	Steel Washer for Control Spindle ..	*	*	*	*	*	*
G476-10	Spring Washer for Control Spindle ..	*	*	*	*	*	*
G476-11	Control Spindle, with Knob ..	*	*	*	*	*	*
G476-12	Rotating Pump Plunger ..	*	*	*	*	*	*
G476-13	Long Extension for Oil Pipe from Tank ..	*	*	*	*	*	*
G476-14	Fibre Washer for Cam Plate ..	*	*	*	*	*	*
G476-15	End Cam Plate ..	*	*	*	*	*	*
G476-16	Screw for End Cam Plate and Plain End Plate ..	*	*	*	*	*	*
G476-17	Short Extension for Oil Pipe to Engine ..	*	*	*	*	*	*
G476-18	Driving Worm, with Shaft ..	*	*	*	*	*	*
G476-19	Plain End Plate (New Type) ..	*	*	*	*	*	*
G476-20	End Plug, screwed (For Early Type Pump) (for Locking Pin for above, see G476-16)	*	*	*	*	*	*
G476-21	Fibre Washer for above ..	*	*	*	*	*	*
G476-22	Spring for Rotating Pump Plunger ..	*	*	*	*	*	*
G476-23	Fibre Washer for Plain End Plate..	*	*	*	*	*	*
G476-24	Ratchet Peg only ..	*	*	*	*	*	*

Where Part Number is given in brackets this number should be quoted.

Quote Part Number, Name of Part, Model, and Year when Ordering.
4.98 h.p. 1926-27 A.J.S. Motor Cycles.

Part No.	DESCRIPTION OF PART.	1926 MODELS			1927 MODELS		
		G8 OHV	G10 OHV	H9 SV	H8 OHV	H9 SV	H10 OHV
Mechanical Oil Pump (SIGHT FEED TYPE ONLY)—Continued.							
G476-25	Ratchet Peg Spring	*	*	*	*	*	*
G476-26	Window Frame only	*	*	*	*	*	*
G476-27	Window only	*	*	*	*	*	*
G476-28	Window Frame Screw	*	*	*	*	*	*
G476-29	Screwed Bush for Driving Worm Shaft	*	*	*	*	*	*
G476-30	Pump Driving Member	*	*	*	*	*	*
G476-31	Suction Pipe (Tank to Pump)	*	*	*	*	*	*
G476-32	Delivery Pipe (Pump to Engine)	*	*	*	*	*	*
NOTE—The above Pump (with Pipes and Tap) may be fitted to 1926 Models, but it is necessary to quote G476-5. (Three hole fitting.)							
Separate Oil Tank & Fittings.							
G476-33	Separate Oil Tank, complete with Fittings, less Handlebar Control and Cable	*	*	*	*	*	*
G476-34	Separate Oil Tank, complete with Fittings, less Brake Pedal and Cable	*	*	*	*	*	*
G476-35	Clips for attaching Tank to Saddle Tube	*	*	*	*	*	*
G476-36	Clips for attaching Tank to Saddle Tube (to be brazed to Frame)	*	*	*	*	*	*
G476-37	Pins for above (5 16 x 1 in., 20 Pkd.)	*	*	*	*	*	*
G476-38	Spring Washers for above (as G213)	*	*	*	*	*	*
G476-39	Bottom Bracket for securing Tank to Bottom Frame Lug	*	*	*	*	*	*
G476-40	Nuts for Tank Studs (as G212)	*	*	*	*	*	*
G476-41	Washers for above (as G213)	*	*	*	*	*	*
G476-42	Handlebar Control, with Clip (less Cable Stop)	*	*	*	*	*	*
G476-43	Handlebar Control Lever only	*	*	*	*	*	*
G476-44	Pin for Control Lever	*	*	*	*	*	*
G476-45	Washer for Control Lever	*	*	*	*	*	*
G476-46	Base and Clip	*	*	*	*	*	*
G476-47	Half Clip only	*	*	*	*	*	*
G476-48	Pin for above	*	*	*	*	*	*
G476-49	Cable for Operating Pump, complete (Handle Control)	*	*	*	*	*	*

Where Part Number is given in brackets this number should be quoted.

Quote Part Number, Name of Part, Model, and Year when Ordering.
4.98 h.p. 1926-27 A.J.S. Motor Cycles.

Part No.	DESCRIPTION OF PART.	1926 MODELS			1927 MODELS		
		G8 OHV	G10 OHV	H9 SV	H8 OHV	H9 SV	H10 OHV
Separate Oil Tank & Fittings (Continued).							
G476-50	Outer Casing of Cable (Hand Control)	*	*	*	*	*	*
G476-51	Inner Wire (Hand Control)	*	*	*	*	*	*
G476-52	Shackle and Cotter (Hand Control)	*	*	*	*	*	*
G476-53	Cable Stop Clip on Handlebar with Pins	*	*	*	*	*	*
G476-54	Bowden Adjuster, in Oil Pump Top	*	*	*	*	*	*
G476-55	Oil Pump Body in separate Oil Tank	*	*	*	*	*	*
G476-56	Oil Pump Elbow	*	*	*	*	*	*
G476-57	Oil Pump Top	*	*	*	*	*	*
G476-58	Oil Pump Catch and Gland Nut	*	*	*	*	*	*
G476-59	Oil Pump Collar Washer	*	*	*	*	*	*
G476-60	Oil Pipe from Tank to Crankcase	*	*	*	*	*	*
G476-61	Union in Tank for above	*	*	*	*	*	*
G476-62	Oil Pipe from Pump, in separate Oil Tank to Crankcase	*	*	*	*	*	*
Accessories (LUCAS ACETYLENE and MAGDYNO LIGHTING SETS; ELECTRIC HORN, &C.)							
G477	Spring Fork Lamp Bracket	*	*	*	*	*	*
G478	Lucas Magdyno Lighting Set complete (Ammeter fitted to Head Lamp)	*	*	*	*	*	*
G479	Lucas Magdyno only	*	*	*	*	*	*
G479-1	Dynamo Armature only	*	*	*	*	*	*
G479-2	Ball Bearing complete (Commutator End)	*	*	*	*	*	*
G479-3	Ball Bearing complete (Driving End)	*	*	*	*	*	*
G479-4	End Cover only	*	*	*	*	*	*
G479-5	Nut and Washer for End Cover	*	*	*	*	*	*
G479-6	Dynamo End Casing, with "Cut-Out" complete	*	*	*	*	*	*
G479-7	"Cut-Out" only complete	*	*	*	*	*	*
G479-8	Main Brushes	*	*	*	*	*	*
G479-9	Control Brush	*	*	*	*	*	*
G479-10	Large Driving Gear Wheel	*	*	*	*	*	*

NOTE * Indicates models for which part is suitable.

For Agent's Use: 1926 MODELS: G8 OHV, G10 OHV, H9 SV, H10 OHV. 1927 MODELS: H8 OHV, H9 SV, H10 OHV.

Part No.	DESCRIPTION OF PART.	NOTE * Indicates models for which Part is suitable.					
		For Agent's Use.	1926 MODELS	1927 MODELS	1928 MODELS	1929 MODELS	1930 MODELS
		3-49 h.p. List No.	G8 OHV	G10 OHV	H8 OHV	H9 SV	H10 OHV
Accessories—Continued.							
G479-11	Small Gear Wheel		*	*	*	*	*
G479-12	Brass Lock Washer for Small Gear Wheel ..		*	*	*	*	*
G479-13	Locknut for above		*	*	*	*	*
G479-14	Locking Washer for Large Driving Gear Wheel		*	*	*	*	*
G479-15	Screw for above		*	*	*	*	*
G479-16	End Plate (Driving Side)		*	*	*	*	*
G479-17	Countersunk Screws for above .. each..		*	*	*	*	*
G479-18	Paper Washer for End Plate		*	*	*	*	*
G480	Lucas 6-Volt Solo Accumulator, less fittings (Moulded Ebonite)		*	*	*	*	*
G480-1	Solo Battery Carrier complete		*	*	*	*	*
G480-2	Knurled Nuts for above.. .. .		*	*	*	*	*
G480-3	6-Volt Solo Accumulator, in Metal Case ..		*	*	*	*	*
G480-4	Metal Case only for above		*	*	*	*	*
G480-5	6-Volt Sidecar Moulded Ebonite Accumulator less fittings		*	*	*	*	*
G480-6	Fittings only for above		*	*	*	*	*
G480-7	Porcelain Vent Plugs for Accumulators each..		*	*	*	*	*
G480-8	Lead Terminal Pieces each..		*	*	*	*	*
G480-9	Hexagon Nuts for Terminals		*	*	*	*	*
G481	Electric Head Lamp, with Bulb (Lucas type R.S.45, with Switch and Ammeter fitted)		*	*	*	*	*
G481-1	Front, with Glass for R.S.45 Head Lamp ..		*	*	*	*	*
G481-2	Glass only for above		*	*	*	*	*
G482	Electric Tail Lamp		*	*	*	*	*
G482-1	Back Portion of Tail Lamp, less Bulb		*	*	*	*	*
G482-2	Front Portion of Tail Lamp		*	*	*	*	*
G482-3	Electric Sidecar Lamp		*	*	*	*	*
G482-4	Front, with Glass for Electric Sidecar Lamp..		*	*	*	*	*
G482-5	Glass only for above		*	*	*	*	*

Part No.	DESCRIPTION OF PART.	NOTE * Indicates models for which Part is suitable.					
		For Agent's Use.	1926 MODELS	1927 MODELS	1928 MODELS	1929 MODELS	1930 MODELS
		3-49 h.p. List No.	G8 OHV	G10 OHV	H8 OHV	H9 SV	H10 OHV
Accessories—Continued.							
G483	Electric Horn, Lucas No. 3	H1614	*	*	*	*	*
G484	Electric Horn, Benjamin	H1616	*	*	*	*	*
G484-1	Switch for Lucas Electric Horn	H1615	*	*	*	*	*
G484-2	Switch for Benjamin Electric Horn	H1617	*	*	*	*	*
G485	Head Lamp Bulb only	H1619	*	*	*	*	*
G486	Sidecar or Tail Lamp Bulb	H1618	*	*	*	*	*
G486-1	Case for Bulbs, with Clip (less Bulbs)	H1620	*	*	*	*	*
G487	Ammeter for Head Lamp	H1627	*	*	*	*	*
G488	5 m.m. Rubber-covered Cable .. per yard	H1630	*	*	*	*	*
G489	Acetylene Projector Set, Lucas No. 4(2b), with Bracket	H1632	*	*	*	*	*
G490	Acetylene Projector Set, Lucas No. 3(2b), with Bracket	H1634	*	*	*	*	*
G490-1	Acetylene Lamp Set for Sidecar, Lucas No. 354		*	*	*	*	*
G491	Not now supplied		*	*	*	*	*
G492	Acetylene Tail Lamp Set, Lucas No. 344	H1635	*	*	*	*	*
G493	Bulb Horn, Lucas No. 69	H1636	*	*	*	*	*
G494	Bulb Horn, Lucas No. 63	H1637	*	*	*	*	*

4.98 h.p. A.J.S. Sidecar Chassis and Body Section.

SPECIAL NOTE.

As several types of Bodies are fitted to different types of Chassis, it has been found necessary, to facilitate the tracing of any particular part, to designate Chassis and Bodies separately as shown on illustrations and on descriptive pages.

If illustrations are referred to, it will be noticed that two types of Chassis are shown, also each type of Body that has been fitted as standard.

Underneath illustrations is given year or years of manufacture and the designation by which each type is known, therefore, a client should carefully compare his Chassis or Body with the illustration and description to arrive at the correct type which is fitted to his machine.

All Chassis and Bodies are now being stamped with the type and number as illustrated below, and this information together with the year of manufacture should in all cases be quoted.

Chassis Type
and Number stamped
here.

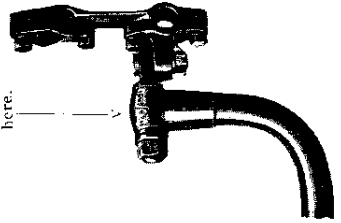

Body Type
and Number stamped
here.

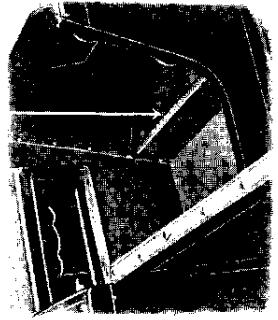

A.J.S. 4.98 h.p. Standard Chassis (Type H2C.)

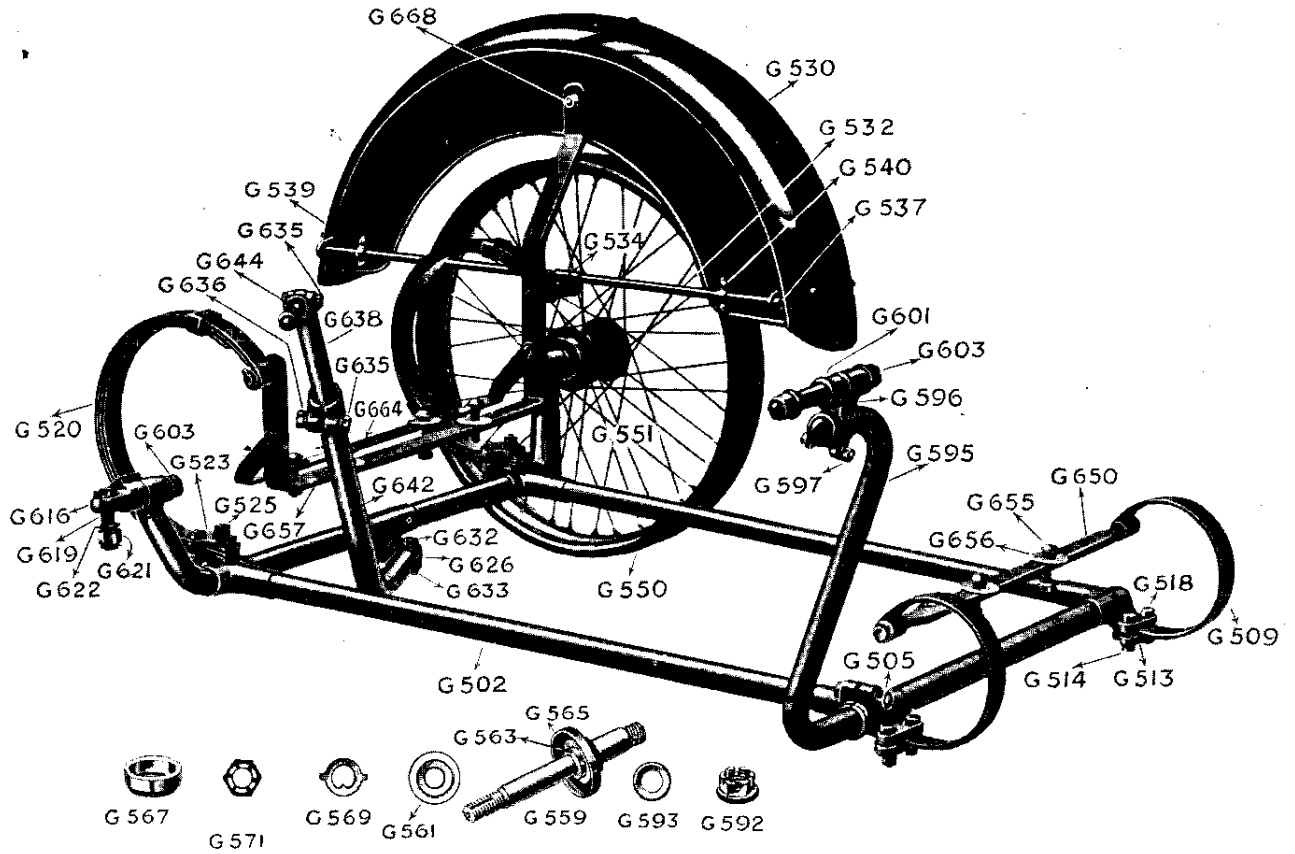

A.J.S. 4.98 h.p. Special Racing Chassis and Expanding Brake Parts. (Type H2D.)

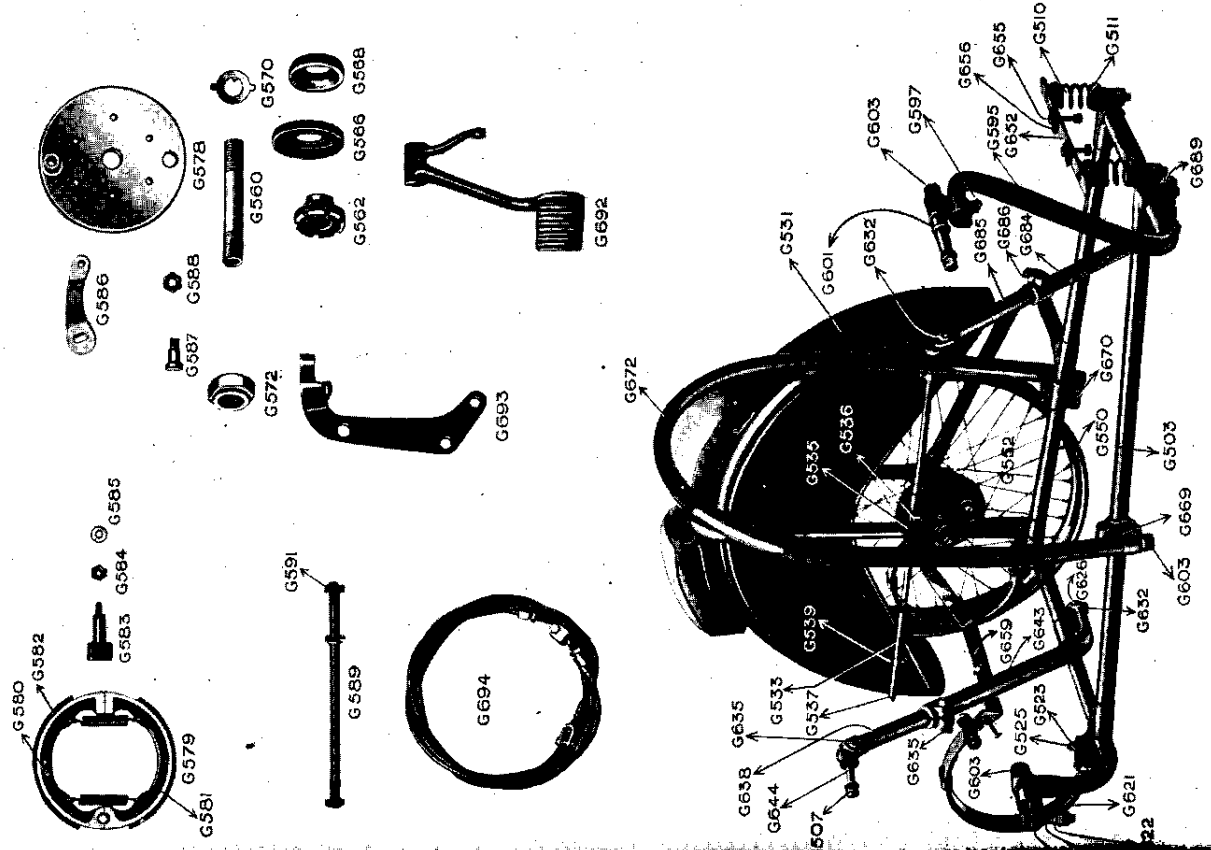

4.98 h.p. 1926-27 A.J.S. Sidecar Bodies.

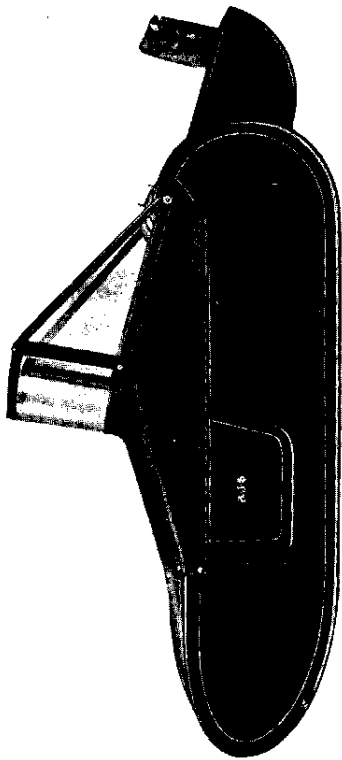

Touring Body, with Child's Seat.
(Type HF 2.)

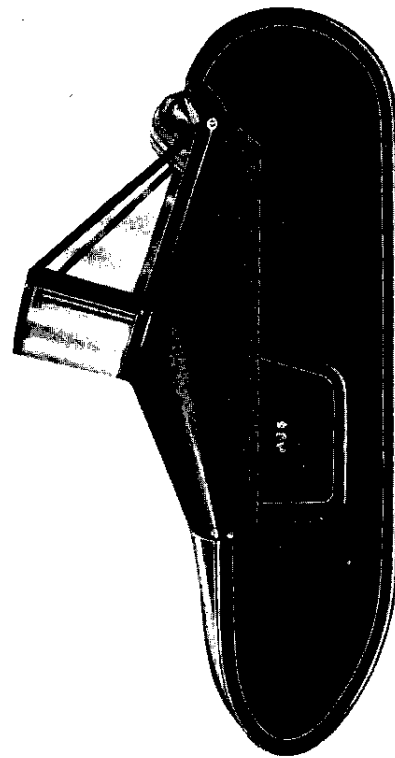

Standard Touring Body.
(Type HE 2.)

4.98 h.p. 1926-27 A.J.S. Sidecar Bodies.

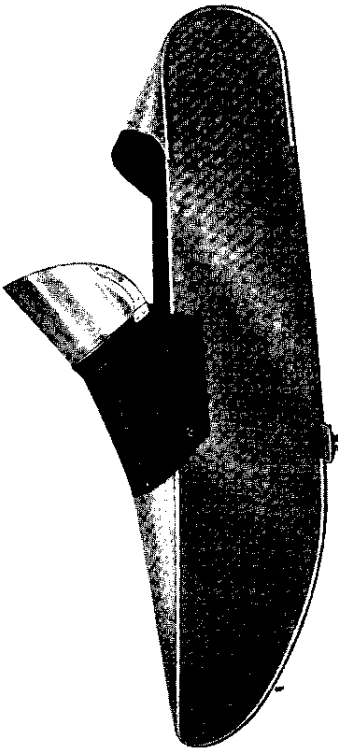

Standard Aluminium Sports Body.
(Type HB 2.)

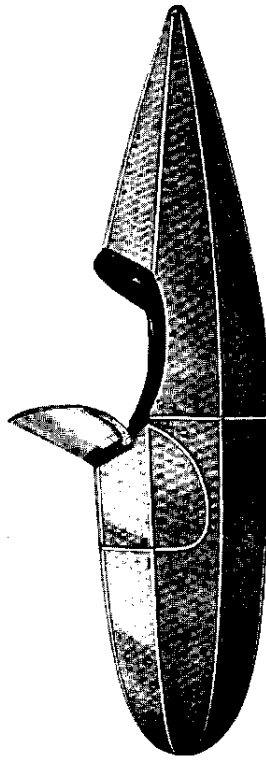

Super Sports Body.
(Type HC 2.)

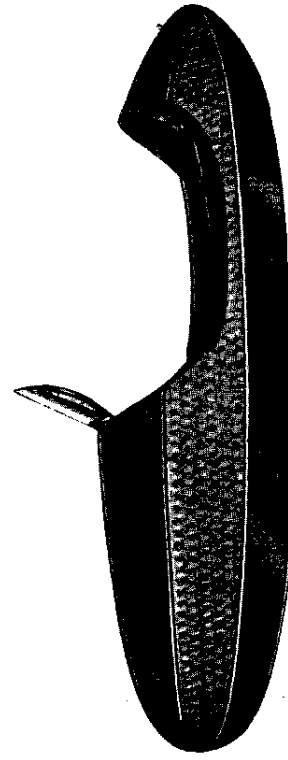

Special Racing Body.
(Type HD 2.)

Quote Part Number, Name of Part, Model, and Year, when Ordering. 4.98 h.p. 1926-27 A.J.S. Sidecar Chassis and Bodies.

NOTE: * Indicates models for which Part is suitable. For Agent's Use. H2C H2D 3.49 h.p. List No.

Part No.	DESCRIPTION OF PART.	H2C	H2D
G500	Chassis, complete with Wheel and Connections, less Tyre	*	*
G501	Chassis, complete with Wheel and Connections, less Tyre	*	*
G502	Chassis Frame only	*	*
G503	Chassis Frame only	*	*
G504	Plug for Front Chassis Tube	H1603	*
G505	Bolt only for Clamping Front Arm in Chassis (½ in., 20 Thd.)	*	*
G506	Bolt only for Clamping Front Arm in Chassis (¼ in., 20 Thd.)	H1694	*
G507	Nut for above (½ in., 20 Thd., ½ in. thick)	H1695	*
G508	Spring Washer for above (½ in.)	H1695	*
G509	Front "C" Springs, Single Leaf		pair..
G510	Front Coil Springs	H1700	pair..
G511	Cups only for Front Coil Springs, top or bottom	H1701	pair..
G512	Spring Clip for Oil Hole	H1714	*
G513	Clamp Plates for Front "C" Springs		each..
G514	Bolts for Clamp Plates		each..
G515	Bolt for Front Coil Springs, top (5/16 x 1½ in., 20 Thd.)	H1702	*
G516	Bolt for Front Coil Springs, bottom (5/16 in.)	H1705	*
G517	Nuts for Spring Bolts (5/16 in., 20 Thd.)	H1707	*
G518	Nuts for Spring Bolts (¼ in., 20 Thd.)	H1706	*
G519	Spring Washer for above (½ in.)	H1720	*
G520	Rear "C" Springs, 3-Leaf		each.
G521	Rear "C" Springs, 3-Leaf	H1713	each..
G523	Spring Clip for Oil Hole (as G512)	H1714	*
G525	Clamp Plate for Rear Springs	H1716	each..
G525	Bolts for Rear Springs	H1718	each..
G525	Nut for above (½ in., 20 Thd.) (as G518)	H1706	*
G525	Spring Washer for above (½ in.) (as G519)	H1720	*

Before ordering Sidecar Chassis or Body Parts see Special Note on page 49. Where Part Number is given in brackets this number should be quoted.

Quote Part Number, Name of Part, Model, and Year, when Ordering. 4.98 h.p. 1926-27 A.J.S. Sidecar Chassis and Bodies.

NOTE: * Indicates models for which Part is suitable. For Agent's Use. H2C H2D 3.49 h.p. List No.

Part No.	DESCRIPTION OF PART.	H2C	H2D
G528	Sidecar Mudguard, with fittings	H1723	*
G529	Sidecar Mudguard, with fittings	H1723	*
G530	Mudguard Blade only	*	*
G531	Mudguard Blade only	H1725	*
G532	Mudguard Cross Stay	H1726	*
G533	Mudguard Cross Stay	H1726-1	*
G534	Mudguard Stay Clip	*	*
G535	Mudguard Stay Strap only	H1728	*
G536	Bolts for Cross Stay Strap	H1729	*
G537	End Bolts for Cross Stay	H1720	*
G538	Plain Washer for above (5/16 x ½ in. x 16G)	H1731	*
G539	Valence Clip for Guard Stay	H1732	*
G540	Pins, Nuts and Washers for above (3/16 Whit. x ½ in. long)	H1733	*
G541	Centre Strap for Mudguard	*	*
G542	Side Strap for Mudguard (Front)	*	*
G543	Side Strap for Mudguard (Rear)	*	*
G544	Side Strap for Mudguard (Front or Rear)	H1735	*
G545	Pins, Nuts and Washers for Straps	H1736	*
G546	Inside Plate for Top Mudguard Attachment	H1737	*
G547	Pin, Nut and Washer for above (5/16 x ½ in., 20 Thd.)	H1738	*
Wheel and Fittings.			
G548	Wheel, complete with Spindle, less Tyre	*	*
G549	Wheel, complete with Spindle and Expanding Brake, less Tyre	*	*
G550	Wheel Rim only	*	*
G551	Wheel Spokes only	set 40	*
G552	Wheel Spokes only, long	set 20	*
G553	Wheel Spokes only, short	set 20	*

Before ordering Sidecar Chassis or Body Parts see Special Note on page 49.

Quote Part Number, Name of Part, Model, and Year, when Ordering. 4.98 h.p. 1926-27 A.J.S. Sidecar Chassis and Bodies.

NOTE * Indicates models for which Part is suitable. For Agent's Use. Chassis

Part No.	DESCRIPTION OF PART.	H2C	H2D
Wheel and Fittings— Continued.			
G554	Single Spoke only	*	*
G555	Nipples for Spokes	*	*
G556	Nipples for Spokes		per set.
G557	Single Nipple only	*	*
G558	Stub Axle, complete with Cones		each.
G559	Stub Axle only	*	*
G560	Hub Hollow Spindle	*	*
G561	Adjustable Cone	*	*
G562	Adjustable Cone	*	*
G563	Fixed Cone	*	*
G564	Hub Dust Cap (Outer)	*	*
G565	Hub Dust Cover (Inner)	*	*
G566	Hub Dust Cover (Inner)	*	*
G567	Hub Cups	*	pair.
G568	Hub Cups	*	pair.
G569	Locking Washer for Cone	*	*
G570	Locking Washer for Cones	*	*
G571	Locknut for Adjustable Cone	*	*
G572	Locknut for Adjustable Cones	*	*
G573	Cutter for above	*	*
G574	Wheel Bearings (1 in.)	*	per set.
G575	Wheel Bearings 5/16 in.	*	per set.
G576	Hub Shell only	*	*
G577	Hub Shell only	*	*
G578	Anchor Plate	*	*
G579	Brake Shoes, with Linings and Springs	*	*
G580	Top Brake Shoe, with Linings	*	*

Before ordering Sidecar Chassis or Body Parts see Special Note on page 49.

Quote Part Number, Name of Part, Model, and Year, when Ordering. 4.98 h.p. 1926-27 A.J.S. Sidecar Chassis and Bodies.

NOTE * Indicates models for which Part is suitable. For Agent's Use. Chassis

Part No.	DESCRIPTION OF PART.	H2C	H2D
Wheel and Fittings— Continued.			
G581	Bottom Brake Shoe, with Lining	H1774	*
G582	Brake Linings, with Rivets	H1775	*
G583	Brake Expander Spindle	H1776	*
G584	Nut for above (1/2 in., 20Thd.)	H1777	*
G585	Washer for above (1/2 in., plain)	H1778	*
G586	Lever for Expander Spindle	H1779	*
G587	Fulcrum Pin for Brake Shoes	H1780	*
G588	Nut for above (1/2 in., 20Thd.)	H1781	*
G589	Solid Centre Spindle	H1782	*
G590	Distance Piece for above	H1783	*
G591	Locknut for Centre Spindle	H1784	*
G592	Nut for Locking Stub Axle to Chassis (3/4 in., 20Thd.)	H1785	*
G593	Large Washer for above (3/4 in., plain)	H1786	*
G594	Cutter for Locknut	H1787	*
Connections.			
G595	Front Bent Arm, with Adjusting Clip		*
G596	Adjusting Clip only for above	H1790	*
G597	Bolt only for Adjusting Clip	H1791	*
	Nut only for above (as G548)		*
G599	Plain Washer for above (3/4 in.)	H1768	*
G601	Main Front Connection Bolt only		*
G603	Large Nuts for above (3/4 in., 20Thd.)	H1794	*
G604	Large Spring Washer for above (3/4 in.)	H1795	*
G616	Rear Connection Eyebolt only	H1806	*
	Nuts for above (3/4 in., 20Thd.) (as G603)	H1794	*
	Spring Washer for above (as G604)	H1795	*
G619	Bolt for Eyebolt and Frame		*

Before ordering Sidecar Chassis or Body Parts see Special Note on page 49. Where Part Number is given in brackets this number should be quoted.

Quote Part Number, Name of Part, Model and Year, when Ordering. 4.98 h.p. 1926-27 A.J.S. Sidecar Chassis and Bodies.

NOTE * Indicates models for which Part is suitable. For Agent's Use. Chassis

NOTE * Indicates models for which Part is suitable. For Agent's Use. Chassis

Connections—Continued.

Connections—Continued.

Table with columns: Part No., DESCRIPTION OF PART., 3.40 h.p. List No., H2C, H2D. Rows include parts like G621 Nut only for above (Castellated, 1/2 in., 20 Thd.), G622 Washer for above (1/2 in. Spring), G623 Cotter for above, G624 Torque Rod complete, with Eye Bolt, G625 Torque Rod complete, with Eye Bolt, G626 Eye Bolt for Torque Tube on Chassis, G632 Bolt only for Yoke End of Torque Tube (Bottom), G633 Nut for above (1/2 in., 20 Thd., Thin), G634 Plain Washer (1/2 in.), G635 Bolt for Clip Lug on Torque Tube, G636 Nut for above (7/16 in., 20 Thd.), G637 Plain Washer for above (7/16 in.), G638 Telescopic Tube only, G642 Torque Tube only, G643 Torque Tube only, G644 Seat Pillar Eye Bolt only, G650 Plain Washer (1/2 in.) (as G634), G652 Front Bearer Bar only (State type of Body fitted), G654 Split Pins for Bearer Bar.

Table with columns: Part No., DESCRIPTION OF PART., 3.40 h.p. List No., H2C, H2D. Rows include parts like G655 Coach Bolts, complete with Nuts, G656 Large Square Hole Washers for above, G657 Rear Bearer Bar (State type of Body fitted), G659 Rear Bearer Bar (State type of Body fitted), G661 Plain Washer for above (1/2 in.) (as G634), G662 Split Cotter, G664 Support for Rear Bearer Bar, G665 Coach Bolts complete for above (1/2 in.), G666 Coach Bolts complete for above (1/2 in.), G668 Countersunk Screw and Nut for Top Mudguard Attachment, G669 Lug for Hand Rail Attachment, G670 Belts for above, G672 Hand Rail Tube, G675 Hand Grip Tube, G676 End Plug for above, G680 Attachment Lug for Hand Grip Tube, G681 Bolts for above (as G670).

Extra Fittings for H2D Chassis.

Before ordering Sidecar Chassis or Body Parts see Special Note on page 49. Where Part Number is given in brackets this number should be quoted.

Before ordering Sidecar Chassis or Body Parts see Special Note on Page 49. Where Part Number is given in brackets this number should be quoted.

Quote Part Number, Name of Part, Model, 4 98 h p. 1926-27 A.J.S. Sidecar and Year, when Ordering. Chassis and Bodies.

NOTE * Indicates models for which Part is suitable. For Agent's Use.

Chassis

Part No.	DESCRIPTION OF PART.	H1C	H21
Extra Fittings for H2D Chassis (Continued)			
G683	Spring Washers for Attachment Lug (as G519)		*
G684	Fourth Point Connection complete		*
G685	Fourth Point Tube only		*
G686	Telescopic Tube only		*
	Bolt only for Clip Lug on Tube (3 in., 20 Tpd.)		*
	Nut for above (as G518)		*
	Plain Washer for above (as G599)		*
G689	Fourth Point Eyebolt on Chassis		*
G690	Clamp Lug on Motor Cycle Down Tube		*
G691	Bolts for Clamp Lug		*
	Spring Washers for above (as G519)		*
	Bolts for Yoke Ends (as G532)		*
	Nuts for above (as G633)		*
	Plain Washer for above (as G634)		*
G692	Pedal for Sidecar Wheel Brake		*
G693	Combined Engine Plate and Cable Stop		*
G694	Cable complete		*

Before ordering Sidecar Chassis or Body Parts see Special Note on page 47. Where Part Number is given in brackets this number should be quoted.

Quote Part Number, Name of Part, Model, 4 98 h p. 1926-27 A.J.S. Sidecar and Year, when Ordering. Chassis and Bodies.

NOTE * Indicates models for which Part is suitable. For Agent's Use.

Bodies

Part No.	DESCRIPTION OF PART.	H1E2	H1E3	H1E4	H1E5	H1E6
Bodies.						
G700	Sidecar Body, complete with Screen and Apron	*				
G701	Sidecar Body, complete with Screen and Apron		*			
G703	Sidecar Body, complete with Screen and Apron	H1896		*		
G704	Sidecar Body, complete with Screen and Apron	H1897		*		
G705	Sidecar Body, complete with Screen and Apron	H1898		*		*
Windscreens & Fittings.						
G706	Windscreen, complete with fittings		*			
G707	Windscreens complete with fittings		*			
G709	Windscreen, complete with fittings	H1900		*		
G710	Windscreen, complete with fittings	H1901		*		*
G711	Windscreen, complete with fittings	H1902		*		*
G712	Windscreen Arm only (Left Hand)		*			
G714	Windscreen Arm only (Right Hand)	H1904		*		
G715	Windscreen Socket (Left Hand)	H1905		*		
G716	Windscreen Socket (Right Hand)	H1906		*		
G717	Windscreen Socket (Right or Left Hand)	H1907		*		*
G718	Plated Wood Screws for above per set.	H1908		*		*
G719	Bridge Strip for Windscreen		*			*
G721	Support Brackets for Windscreens	H1910		*		*
G722	Wood Screws for above doz.	H1911		*		*
G723	Turn Bitton and Eyelets for Screens doz.	H1910		*		*
G724	Peg Studs complete for Screens doz.	H1917		*		*
Aprons & Fittings.						
G725	Sidecar Apron, with fittings		*			*
G726	Sidecar Apron, with fittings		*			*
G728	Sidecar Apron, with fittings	H1913		*		*
G729	Sidecar Apron, with fittings	H1914		*		*
G730	Sidecar Apron, with fittings	H1915		*		*

Before ordering Sidecar Chassis or Body Parts see Special Note on page 49.

Quote Part Number, Name of Part, Model, 4.98 h.p. 1926-27 A.J.S. Sidecar and Year, when Ordering. Chassis and Bodies.

NOTE * Indicates models for which Part is suitable.

Bodies

Part No.	DESCRIPTION OF PART.	For Agent's Use.												
		3.49 h.p. Int. No.	HE2	HF2	HB2	HC2	HD2	HE2	HF2	HB2	HC2	HD2		
Aprons and Fittings (Continued)														
G733	Turn Buttons and Eyelets for Aprons (as G723)	doz...	H1916	*	*	*	*	*	*	*	*	*	*	*
G734	Peg Studs complete (as G724)	doz...	H1917	*	*	*	*	*	*	*	*	*	*	*
Body Fittings.														
G735	Door Hinge only	..	H1918	*	*	*	*	*	*	*	*	*	*	*
G736	Woodscrews for above	.. set..	H1921	*	*	*	*	*	*	*	*	*	*	*
G737	Door Lock complete	*	*	*	*	*	*	*	*	*	*	*
G738	Door Knob only	..	H1919	*	*	*	*	*	*	*	*	*	*	*
G739	Hinges for Rear Squab	.. pair..	H1922	*	*	*	*	*	*	*	*	*	*	*
G740	Hinges for Dickey Seat	.. pair..	..	*	*	*	*	*	*	*	*	*	*	*
G741	Woodscrews for above	.. set..	H1923	*	*	*	*	*	*	*	*	*	*	*
G742	Plunger, with Spring Clip and Plate for Rear Squab	..	H1934	*	*	*	*	*	*	*	*	*	*	*
G743	Plunger only	..	H1925	*	*	*	*	*	*	*	*	*	*	*
G744	Spring Clip only	..	H1925	*	*	*	*	*	*	*	*	*	*	*
G745	Base Plate only	..	H1927	*	*	*	*	*	*	*	*	*	*	*
G746	Screws for Base Plate	.. set..	H1928	*	*	*	*	*	*	*	*	*	*	*
G747	Screws for Plunger	.. set..	H1929	*	*	*	*	*	*	*	*	*	*	*
G748	Lock for Dickey Seat	*	*	*	*	*	*	*	*	*	*	*
G749	Key for above..	*	*	*	*	*	*	*	*	*	*	*
G750	Check for Dickey Seat, with Spring and Plate	.. pair	..	*	*	*	*	*	*	*	*	*	*	*
G751	Screws for above	.. set..	..	*	*	*	*	*	*	*	*	*	*	*
G752	Plunger only for Windscreen Flap..	..	H1930	*	*	*	*	*	*	*	*	*	*	*
G753	Plate for Spring Clip (Spring Clip and Screens same as for Squab)	..	H1931	*	*	*	*	*	*	*	*	*	*	*
G754	Hinges for Windscreen Flap	.. pair..	H1932	*	*	*	*	*	*	*	*	*	*	*
G755	Hinged Check for Windscreen Flap	..	H1933	*	*	*	*	*	*	*	*	*	*	*
G756	Plate only for above	..	H1934	*	*	*	*	*	*	*	*	*	*	*
G757	Wood Screws for above	.. set..	H1935	*	*	*	*	*	*	*	*	*	*	*

Before ordering Sidecar Chassis or Body Parts see Special Note on page 49. Where Part Number is given in brackets this number should be quoted.

Engine.

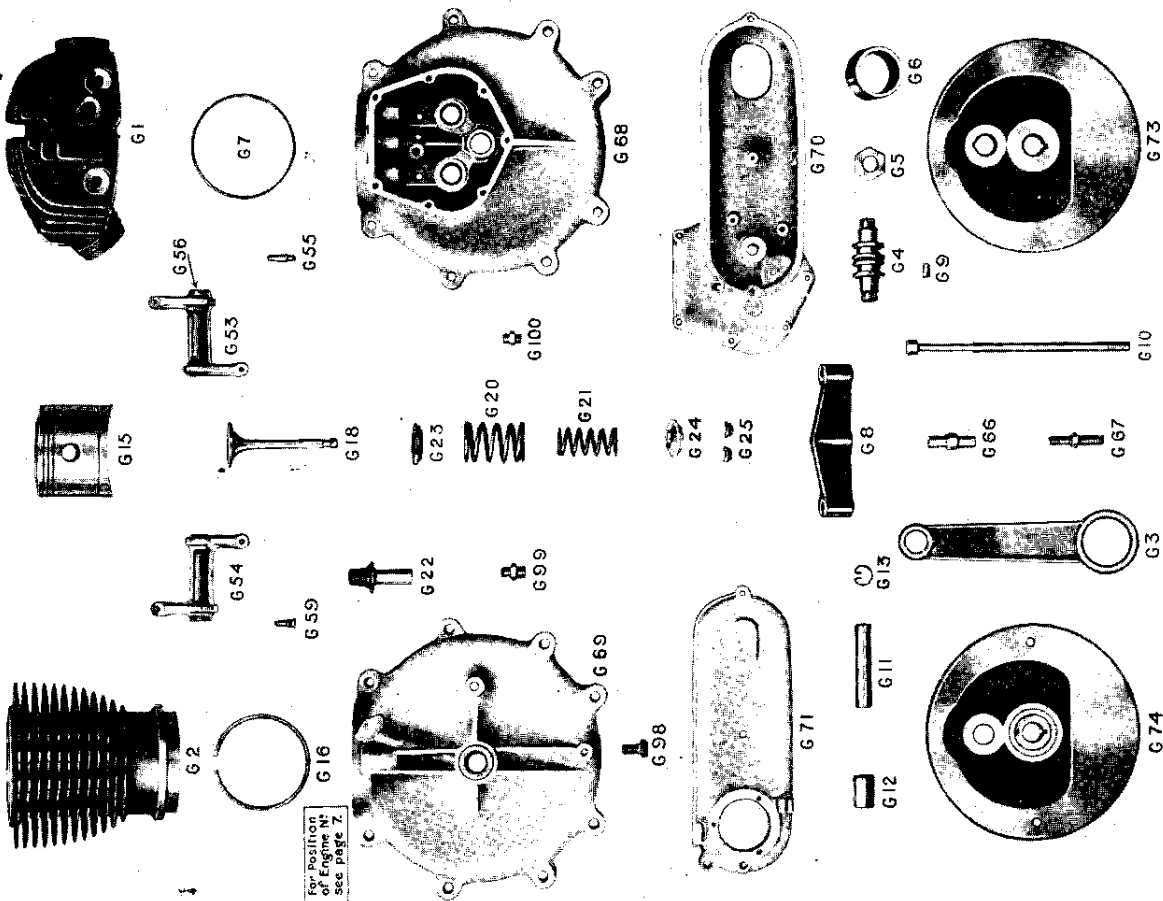

Engine Continued.

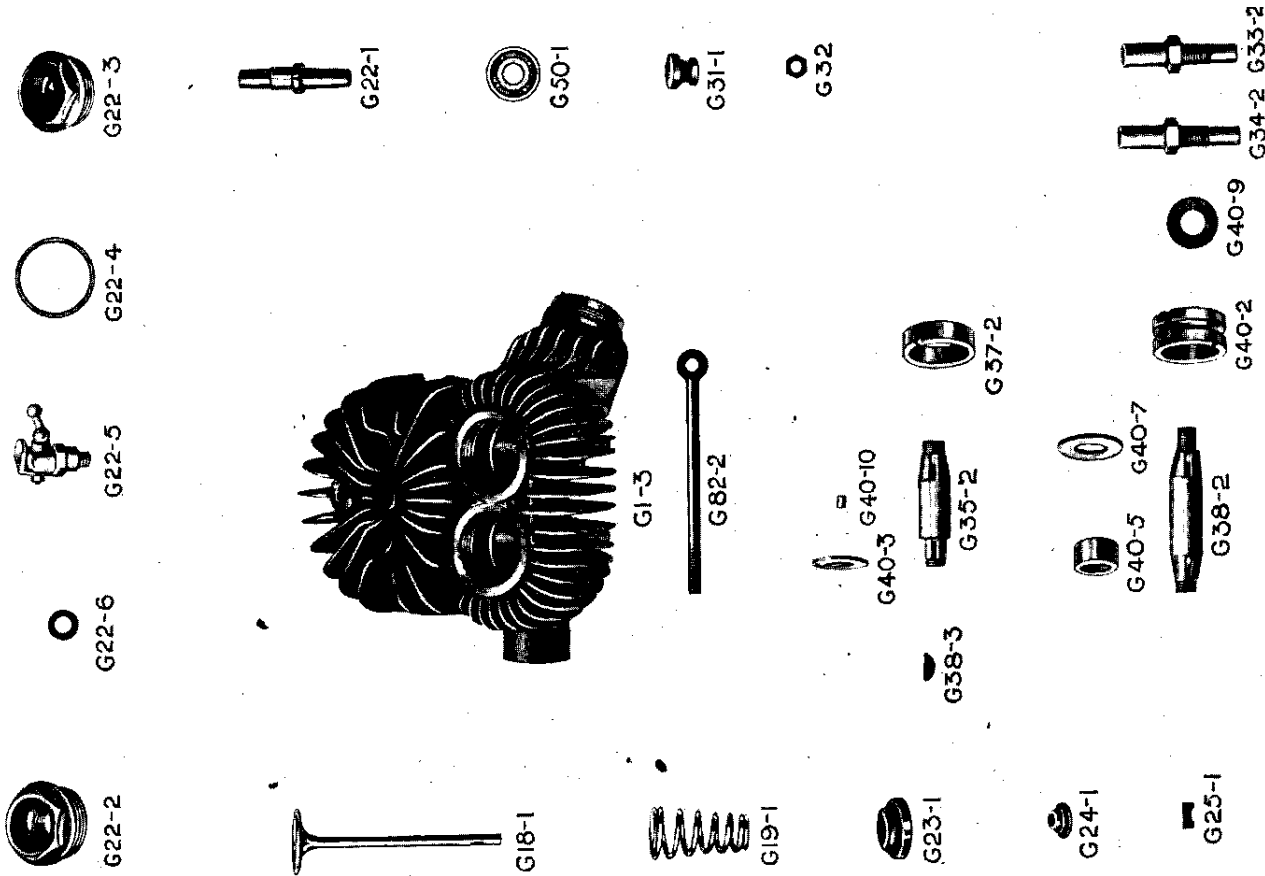

Engine—Continued.

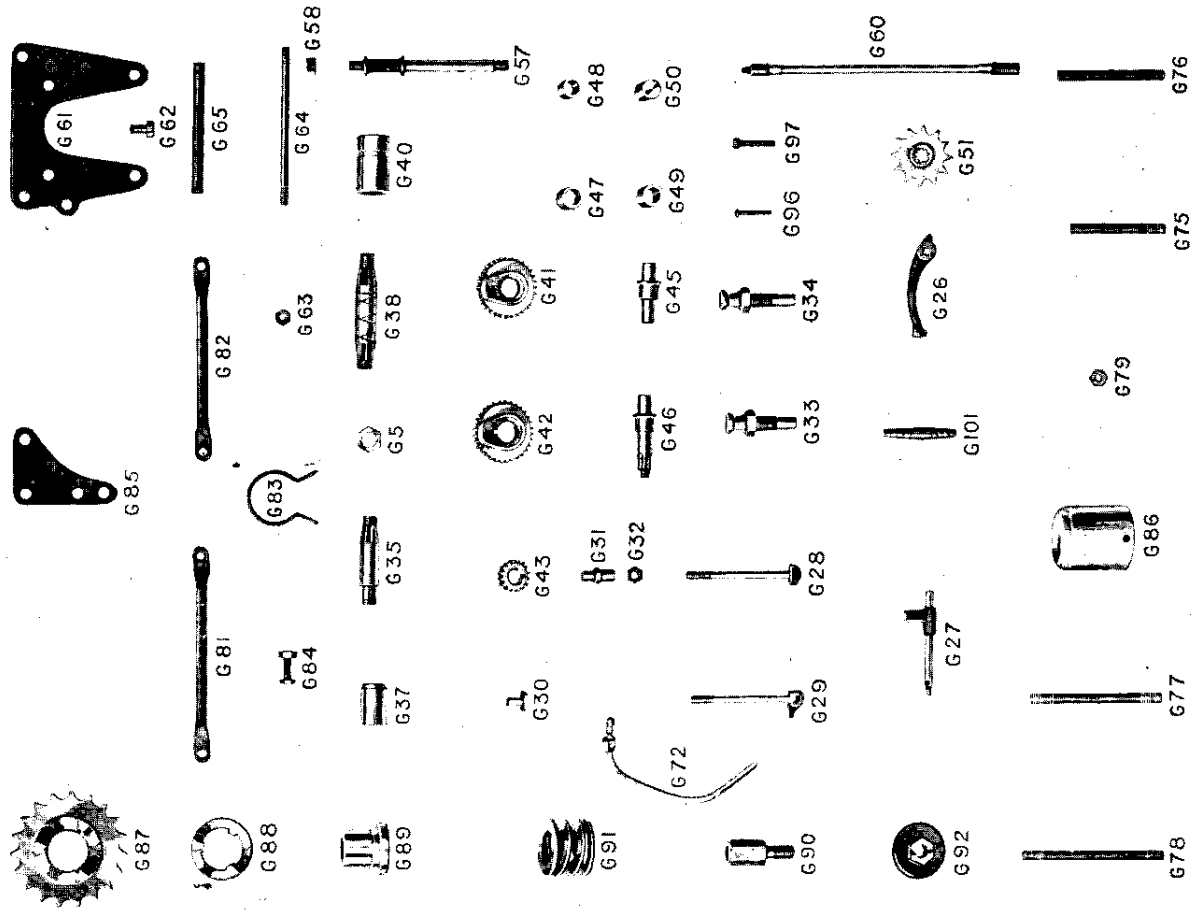

Gearbox and Clutch.

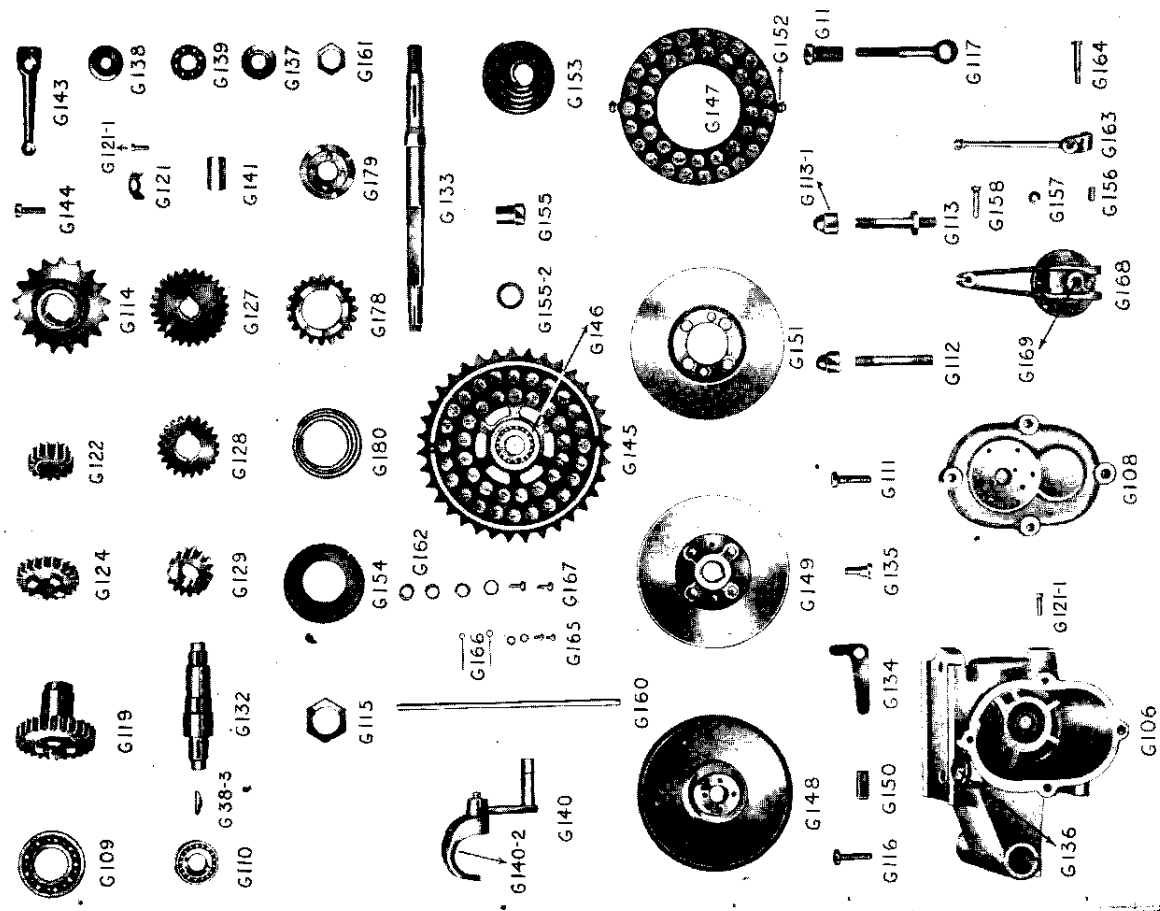

Footstart, Gate Change, Magneto and Shield, Tank and Chaincase Fittings.

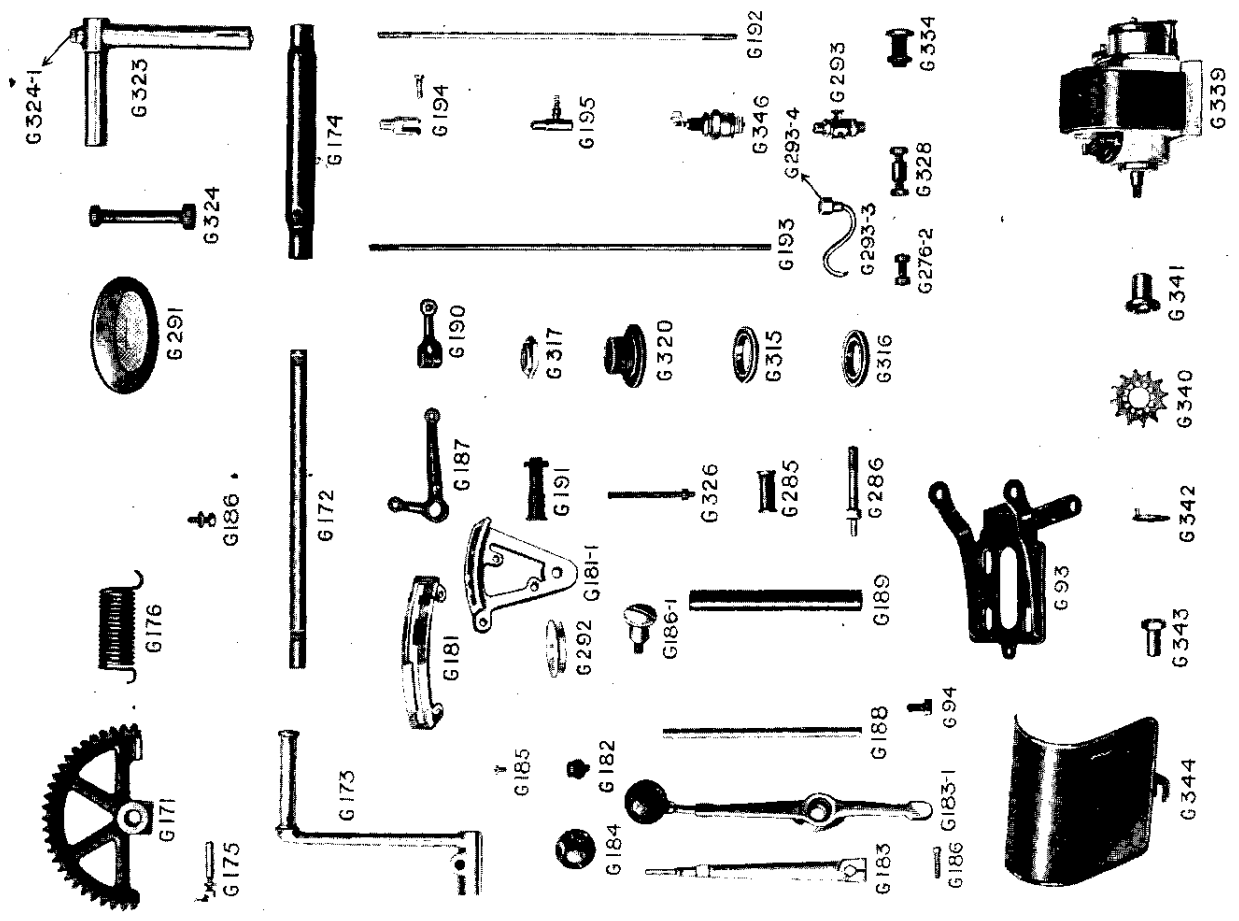

Front and Rear Expanding Brake and Hub.

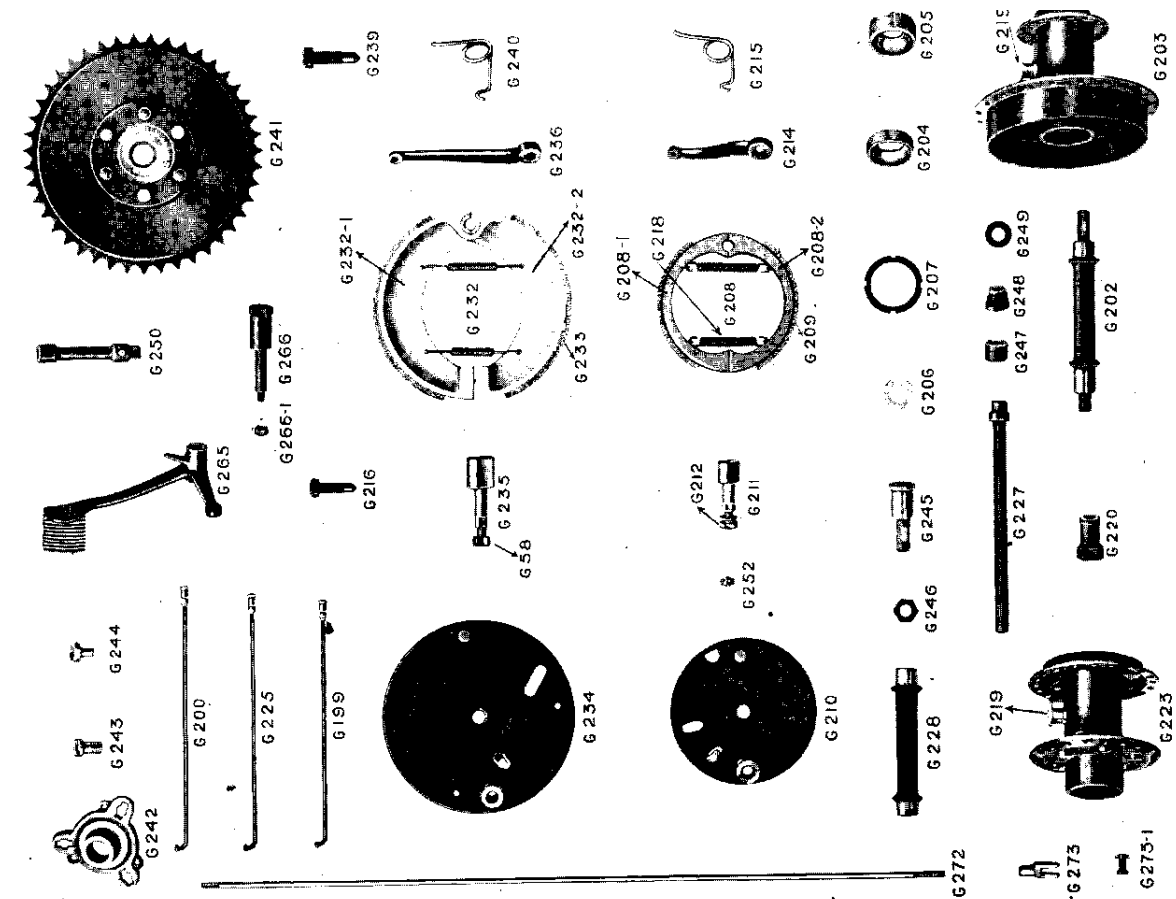

Spring Forks, Frame, Tank, Chaincases, etc.

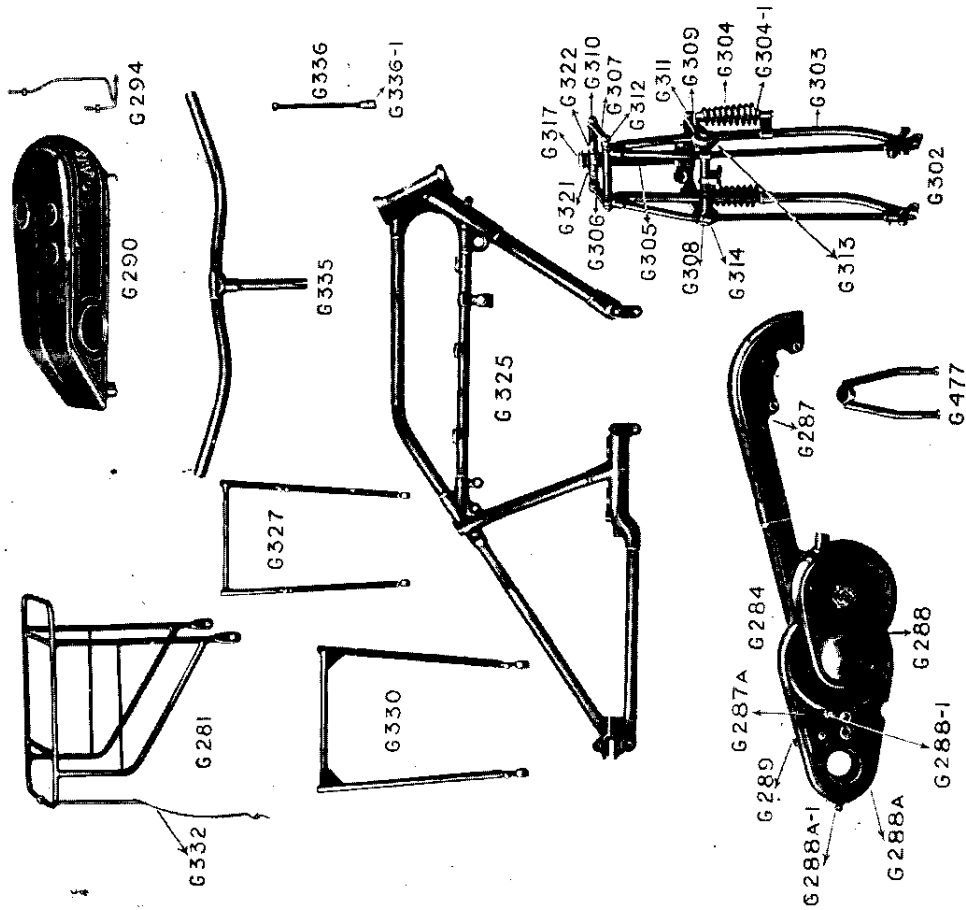

Mudguards, Exhaust System, Front & Rear Wheels, etc.

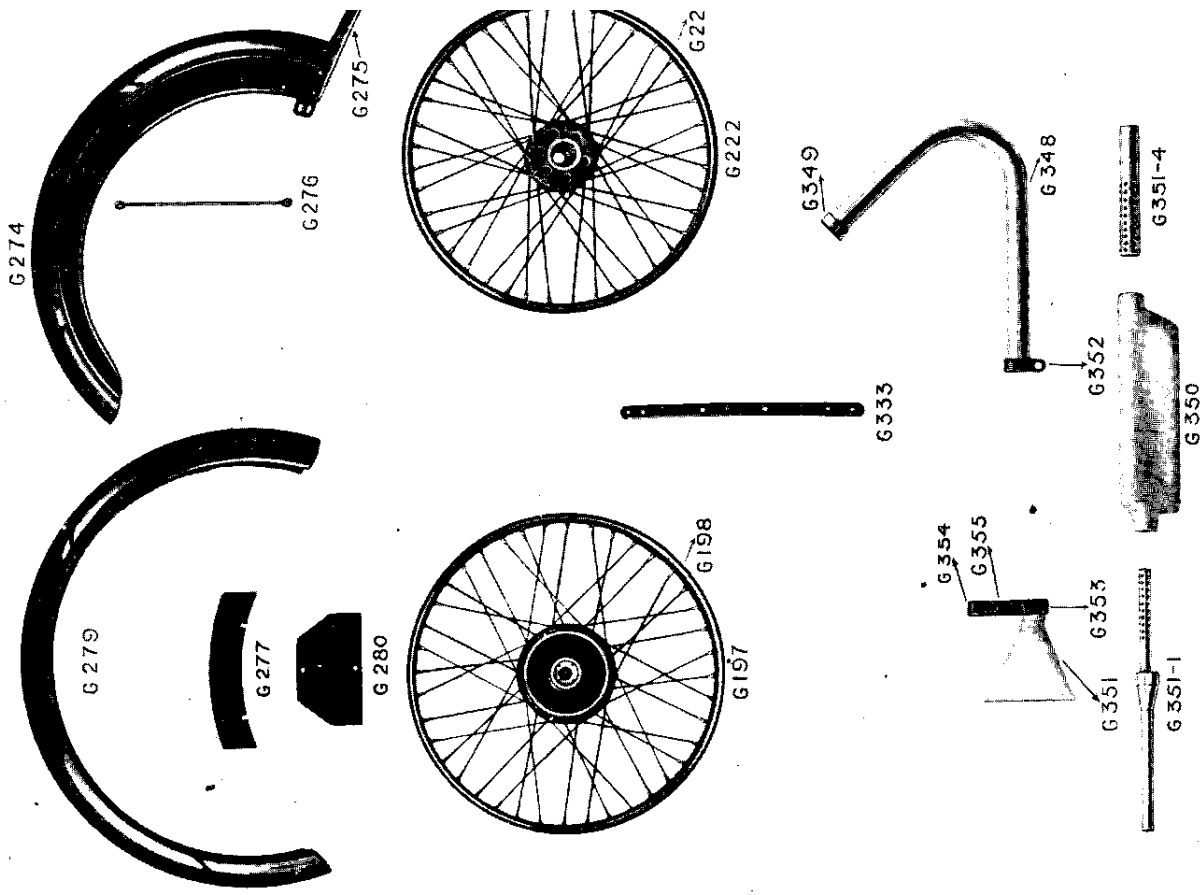

Legshields, Racing Front Guard and Stays, Chainguards and Separate Oil Tank.

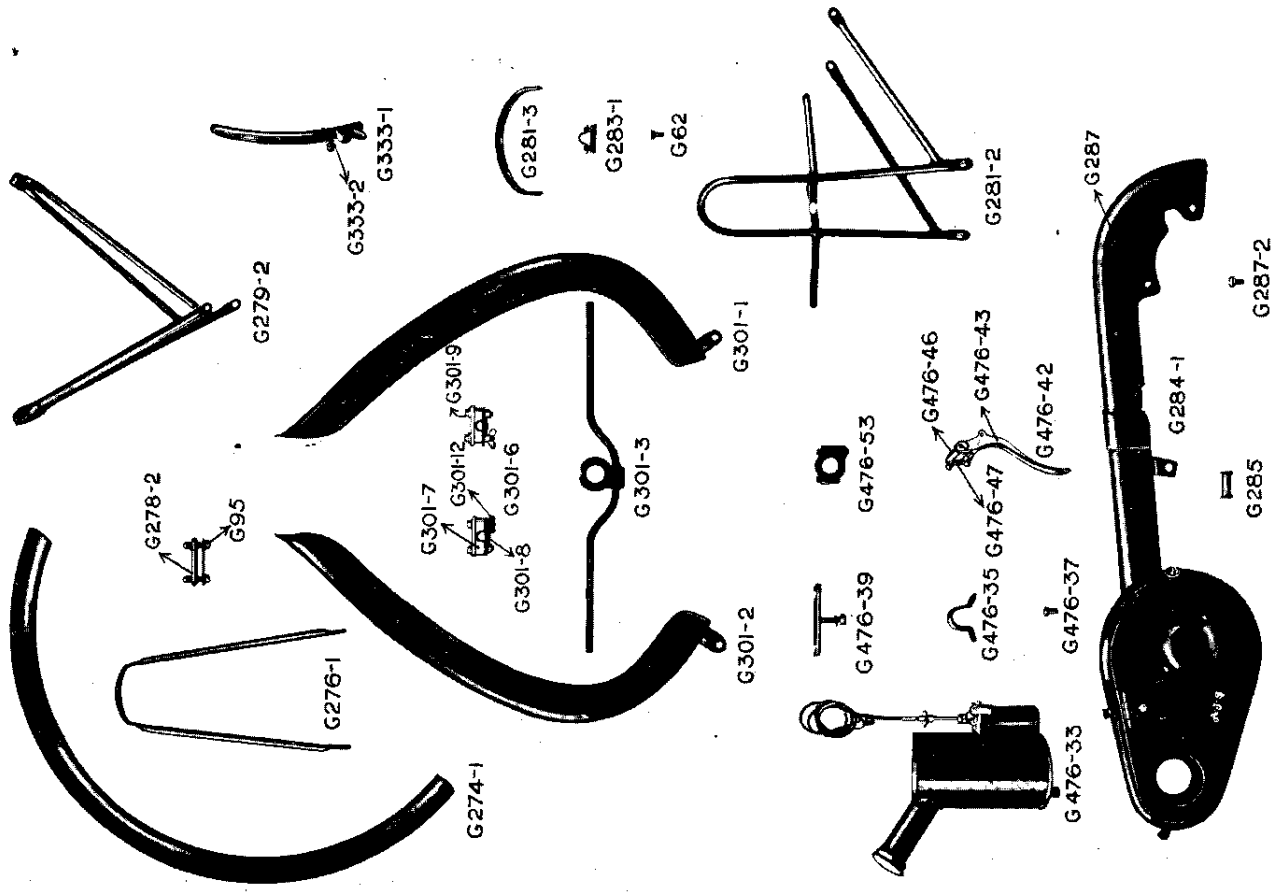

Driving Chains Carburettor, Control Levers & Cables.

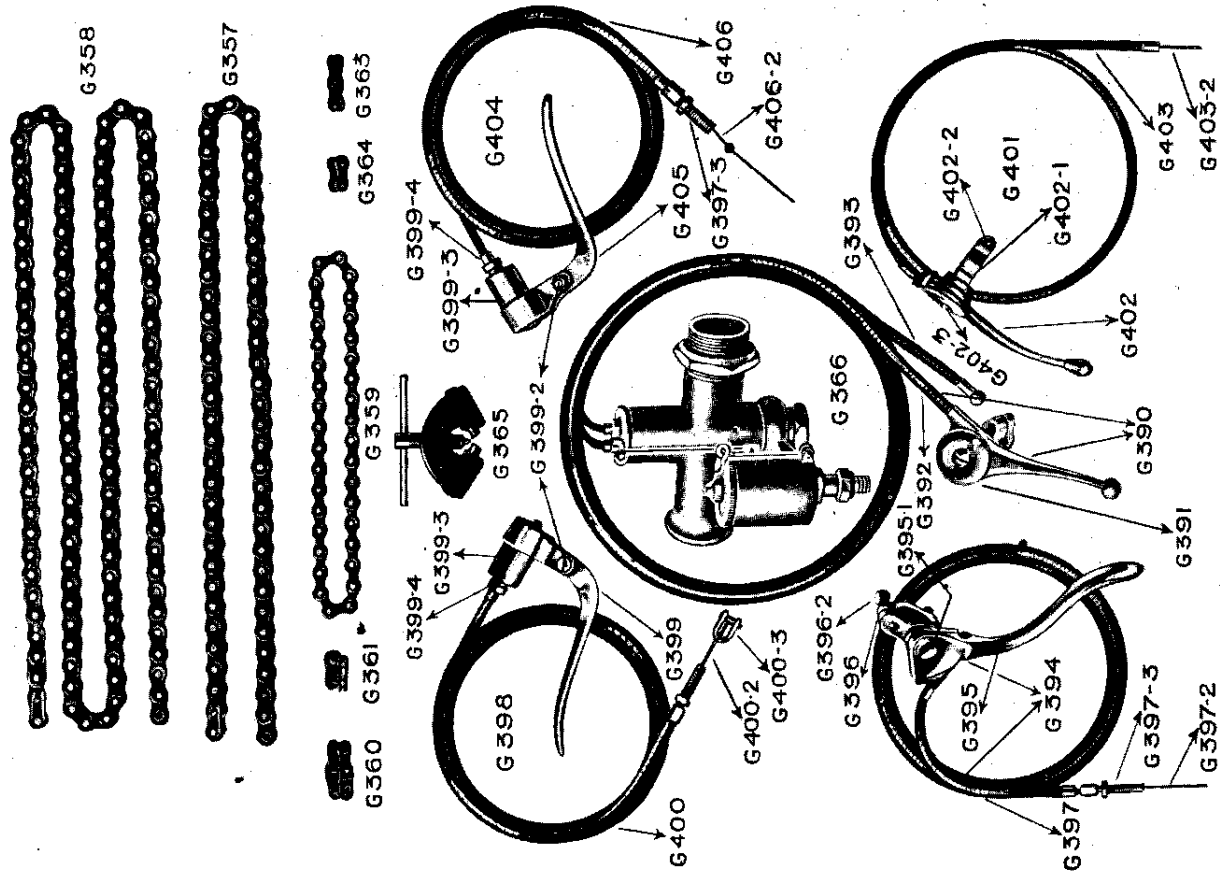

A.J.S. & Binks' Twist Grip Control Footrests, etc.

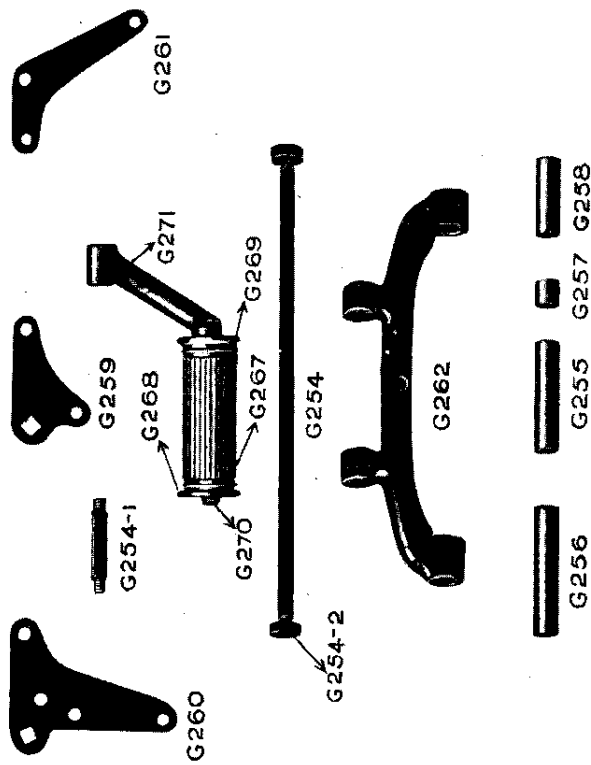
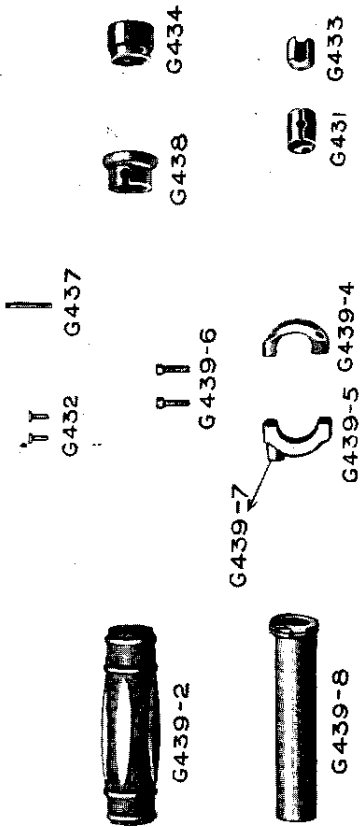
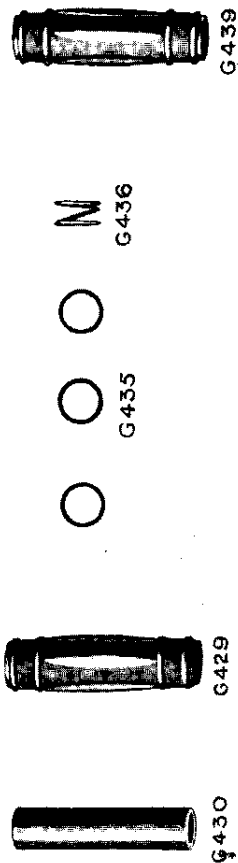

Magneto and Magdyno Parts.

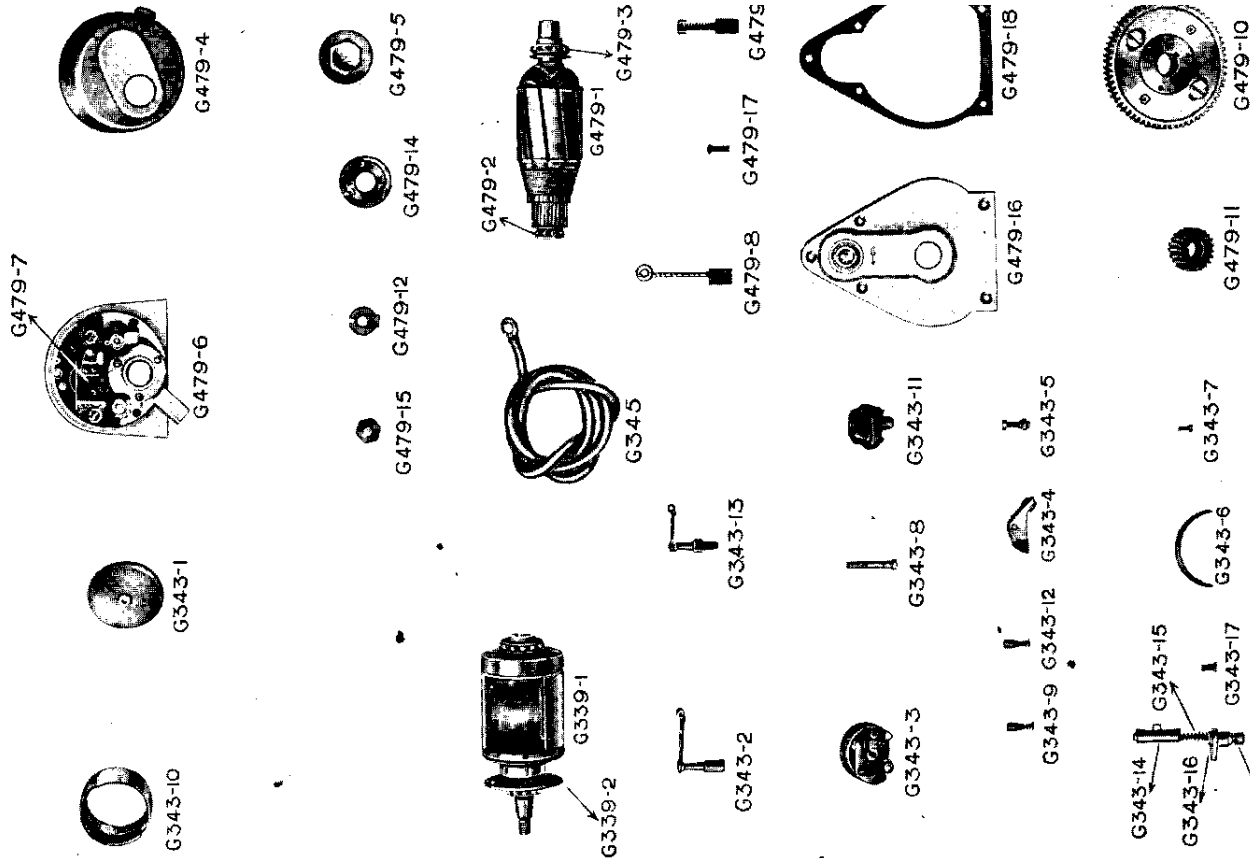

Binks' Carburettor.

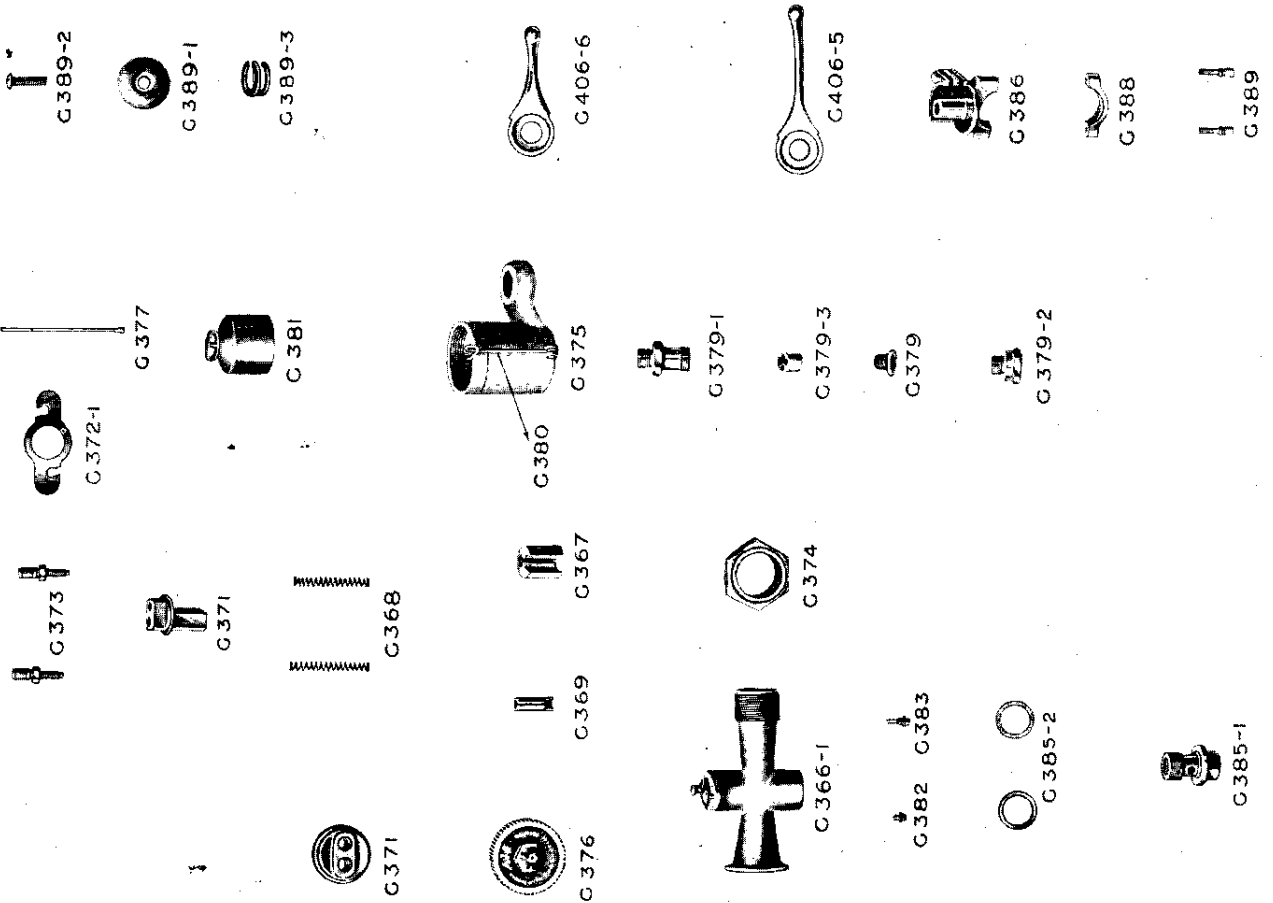

Oil Pumps Hand, Non-Sight Feed and Sight-Feed Typ

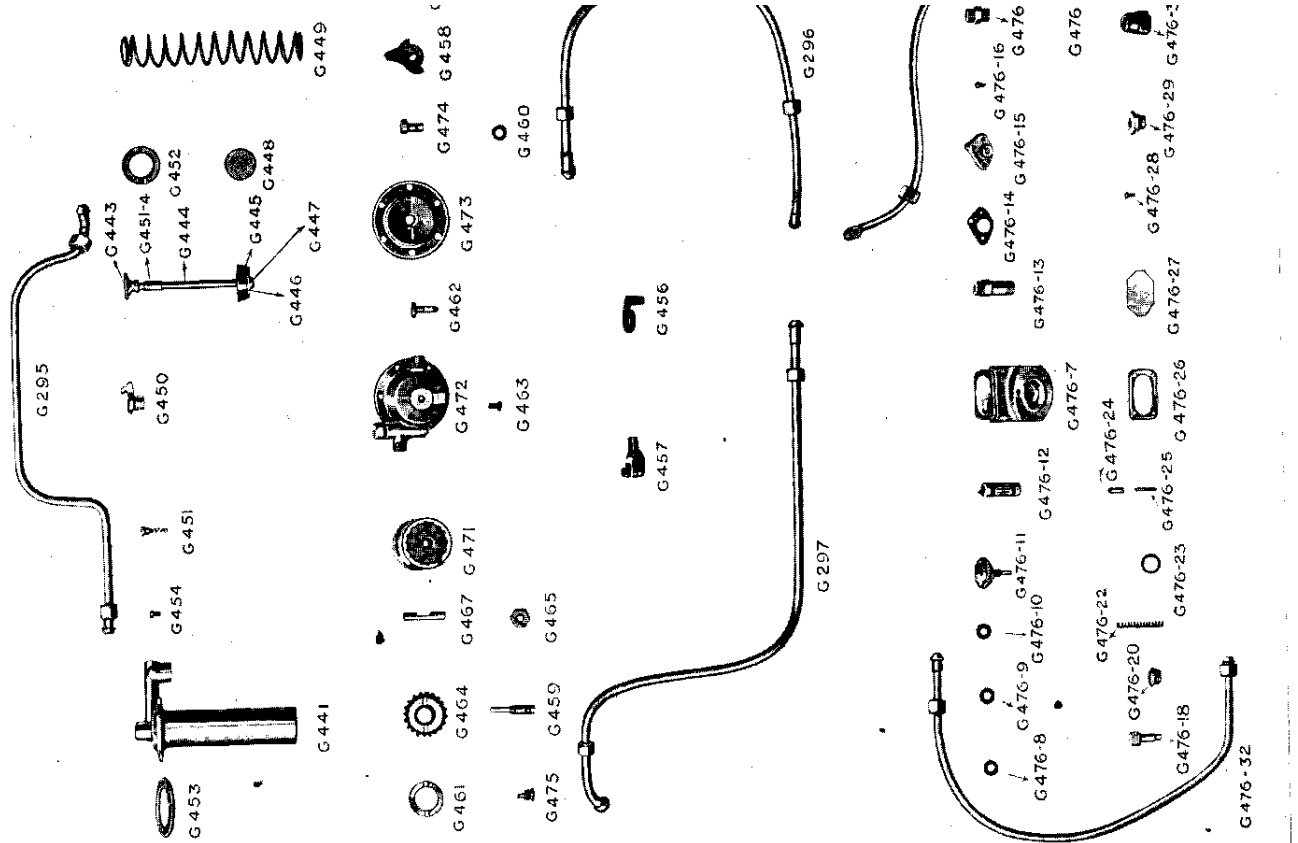

Tool Kit, Saddle, Tool Case, etc.

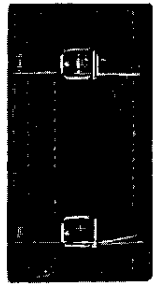

G 282

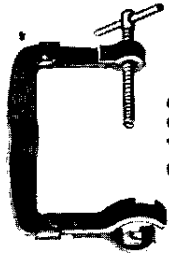

G 422



G 426



G 299



G 337



G 337-3

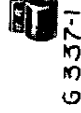

G 337-1

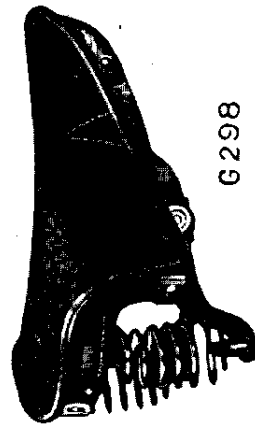

G 298

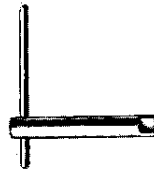

G 423



G 424

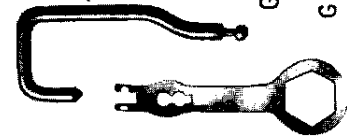

G 422-1



G 424-2

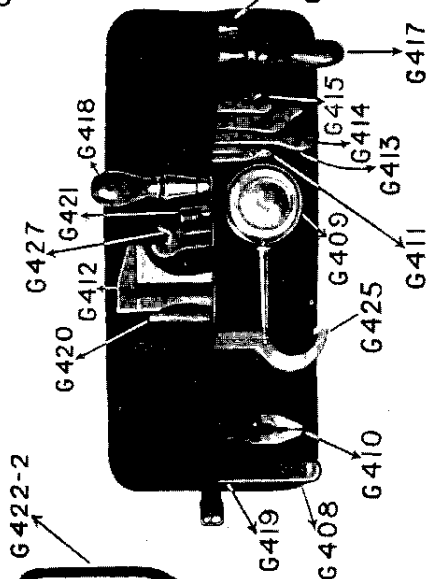

G 422-2

G 420
 G 412
 G 427
 G 421
 G 418
 G 419
 G 408
 G 425
 G 409
 G 415
 G 414
 G 413
 G 411
 G 417
 G 428