

LUCAS
GIRLING

**EQUIPMENT AND
SERVICE PARTS**

CE 825/66

**NORTON -
MATCHLESS**

Motor Cycles

1966





EQUIPMENT SPECIFICATIONS AND PAGE INDEX

NORTON MOTOR CYCLES

UNIT	See Page	249 c.c. 'Jubilee'		350 c.c. '50' Mk. II 500 c.c. 'ES2' Mk. II	
		Model	Part No.	Model	Part No.
ALTERNATOR	8	—	—	RM19	§54021027
Stator ...	8	—	—	—	47162A
Rotor ...	8	—	—	—	54213901
AMMETER	8	—	—	2AR	36296A
BATTERY	—	—	—	PUZ7E-11	24082087
CABLE HARNESS	5	—	—	—	54937260
COIL IGNITION	8	—	—	MA6	45152A/B
CONTACT BREAKER	8	—	—	4CA	‡47618A/B
				4CA	*47615A
					(54415296)
					(54416405)
HORN	9	8H	70163B	8H	70163A/B
HORN PUSH AND DIPPER SWITCH	9	—	—	25SA	31563D
LAMPS					
Head					
Home and Export ...	10	—	—	MCH61	59171A
Home and Export ...	10	—	—	MCH61	‡59252A
Export Europe, except France	10	—	—	MCH61	59172A
Export France	10	—	—	MCH61	59173B
Stop tail, number plate and reflex	11	564	53432D	564	53432B/D
MAGNETO	7	—	—	NI-4	‡42272B
RECTIFIER	8	—	—	2DS506	49072A
SWITCHES					
Lighting ...	9	—	—	88SA	§34289A
Knob (supplied separately)	9	—	—	—	54330934
Ignition ...	9	—	—	88SA	§34427B
Cover (supplied separately)	9	—	—	—	5433617B
Stop lamp ...	9	—	—	22B	31383A/B
Magneto cut-out ...	9	—	—	4A	76204D
Rubber pad ...	9	—	—	—	380459
REAR SUSPENSION UNIT (Serviced by Girling Ltd.)	—	—	3939(SB3)	—	4174

UNIT	See Page	497 c.c. '885S' 647 c.c. '650SS' 12 Volt		650 c.c. 'Manxman' (U.S.A. only) 750 c.c. 'Atlas' 12 Volt		750 c.c. 'N115CS' Export 750 c.c. 'N115' Home and Export	
		Model	Part No.	Model	Part No.	Model	Part No.
ALTERNATOR	8	RM19	§54021027	RM19	§54021027	RM19	§54021027
Stator ...	8	—	47162A	—	47162A	—	47162A
Rotor ...	8	—	54213901	—	54213901	—	54213901
AMMETER	8	2AR	36296A	2AR	36296A	2AR	36296A
BATTERY (2 off)	—	MKZ9E-2	54028050	MKZ9E-2	54028050	MKZ9E-2	54028050
CABLE HARNESS	5	—	*54932248	—	54935175	—	54935167
CABLE HARNESS (Export U.S.A.)	5	—	—	—	54939968	—	54939967
CABLE HARNESS (Europe)	5	—	*54934995	—	—	—	54935009
DIODE, ZENER	8	ZD715	49345A	ZD715	49345A	ZD715	49345A
HORN	9	6H	*70197A (70183)	6H	*70197A (70183)	6H	*70197A (70183)
HORN PUSH AND DIPPER SWITCH	9	25SA	31563D	25SA	31563D	25SA	31563D
LAMPS							
Head							
Home and Export, vertical dip	10 & 11	MCH61	59252A	SS700P	59281A	SS700P	59281A
Export Europe, except France	10	MCH61	59254A	—	—	MCH61	59254A
Export France	10	MCH61	59253A	—	—	—	—
Export U.S.A.	11	—	—	SS700P	59666A	SS700P	59666A
Stop tail, number plate and reflex	11	564	53454B/D	564	53454B/D	564	53454B/D
Stop tail, number plate and reflex, U.S.A.	11	—	—	679	53973A/B	679	53973A/B
MAIN BEAM WARNING LIGHT	11	—	—	WL15	§38189A	WL15	§38189A
MAGNETO	6	K2F	42453A	K2F	42453A	K2F	42453A
AUTO ADVANCE UNIT	6	—	47508D	—	47508D	—	47508D
RECTIFIER	8	2DS506	49072A	2DS506	49072A	2DS506	49072A
SWITCHES							
Lighting ...	9	88SA	§34289A	88SA	§34289A	88SA	§34289A
Knob (supplied separately)	9	—	54330934	—	54330934	—	54330934
Magneto cut-out ...	9	4A	76204D	4A	76204D	4A	76204D
Stop lamp ...	9	22B	31383B	22B	31383B	22B	31383B
Rubber pad ...	9	—	380459	—	380459	—	380459
REAR SUSPENSION UNIT (Serviced by Girling Ltd.)	—	—	4423(SB3)	—	4423(SB3)	—	—

§ For reference only, serviced by Rotor and Stator. ‡ 350 c.c. model only. † Optional. ‡‡ Optional when magneto is fitted. ° Europe and France. ** Home and Export
* When ordering, quote part number shown in brackets. † Part of headlamp.



EQUIPMENT SPECIFICATIONS AND PAGE INDEX

FRANCIS-BARNETT MOTOR CYCLES

UNIT	See Page	'Plover 96'		'Trials' and 'Scrambler'		'Cruiser 89' and 'Sports Cruiser 91'		Falcon '87'	
		Model	Part No.	Model	Part No.	Model	Part No.	Model	Part No.
BATTERY	—	PUZ5E-10	24082044	—	—	MLZ9E	54028263	MLZ9E	54028459
HORNS	9	—	—	—	—	8H	70163A/B	8H	70163A/B
SUPPRESSOR	9	WS11	78118A	WS11	78118A	WS11	78118A	WS11	78118A
SWITCHES									
Stop lamp	9	—	—	—	—	22B	**31511A/B	22B	31511A/B
REAR SUSPENSION UNIT (Serviced by Girling Ltd.)	—	—	3125	—	4555(SB'3)	—	4198(SC3-8)	—	3028(SB3)

JAMES MOTOR CYCLES

UNIT	See Page	'Comet' 'Commando' and 'Cotswold'		'Cadet M16'		'Captain L20' 'Sports Captain L20S' and 'Sports Superswift M25S'	
		Model	Part No.	Model	Part No.	Model	Part No.
BATTERY	9	—	—	PUZ5E-10	24082044	MLZ9E	54028459
HORN	9	—	—	—	—	8H	70163A/B
SUPPRESSOR	9	WS11	78118A	WS11	78118A	WS11	78118A
REAR SUSPENSION UNIT (Serviced by Girling Ltd.)	—	—	††3125	—	2135	—	4198(SC3.8)
	—	—	SB4/253A/D	—	—	—	†4258(SC3.8)

CABLE HARNESSES

Part No.	54932248	54932304	54934821	54934995	54935009	54935167	54935175	54937260	54939967	54939968
Eyelet flag (1/8")	—	—	—	—	187709	—	—	—	—	—
Eyelet flag (1/4")	187704	—	187704	187704	—	—	187704	187704	—	187704
Eyelet (1/8")	—	850406	850406	850401	850406	850406	850406	850406	850406	850406
Eyelet (1/4")	—	—	850405	—	—	—	—	—	—	—
Eyelet (1/8") short	—	—	187009	187009	—	—	—	187009	—	—
Eyelet (1/4")	900450	900450	—	900450	—	—	—	900450	—	900450
Eyelet (1/8")	187009	—	—	—	—	—	—	—	—	—
Eyelet	—	54940890	—	—	—	—	—	—	—	—
Nipple	900269	900269	900269	900269	900269	900269	900269	900269	900269	900269
Connector, Lucar (17.5 amp.)	54942078	54942078	54942078	54942078	54942078	54942078	54942078	54942078	54942078	54942078
Connector, Lucar (35 amp.)	—	—	54942079	54942079	54942079	54942079	54942079	—	54942079	54942079
Connector, Lucar, double (17.5 amp.)	54942747	54942747	54942747	54942747	54942747	54942747	54942747	—	54942747	54942747
Sleeve, Lucar (17.5 amp.)	54190042	54190042	54190042	54190042	54190042	54190042	54190042	54190042	54190042	54190042
Sleeve, Lucar (35 amp.)	—	—	54190043	54190043	54190043	54190043	54190043	—	—	54190043
Sleeve, Lucar, double (17.5 amp.)	54190119	54190119	54190119	54190119	54190119	54190119	54190119	54190119	54190119	54190119
Connector tube (2-way)	900288	900288	900288	900288	900288	900288	900288	900288	900288	900288
Connector tube (4-way)	—	—	850641	850641	850641	—	850641	850641	850641	850641
Connector tube (6-way)	—	—	850644	—	—	—	850644	850644	—	—
Connector tube (10-way)	—	—	—	—	—	—	850832	—	850832	850832
Socket	—	809795	—	—	—	—	—	—	—	—
Bulbholder	—	—	—	—	—	—	—	862847	54945043	945043
Bulb	—	—	—	—	—	—	990	281	281	281

** 'Cruiser 89' only

†† 'Comet' only.

† 'Sports Superswift M25S' only.



AUTO ADVANCE UNIT

Part No.	47508A/D
Model	K2F
Washer, cover clip	498131
Washer, disc cover	498339
Spring, set	498157/S
Nut, fixing	498303

MAGNETOS

Part No.	42264D	42453A
Model	K2F	K2F
Clip, pick up cover	455734	—
Cover, pick up (rubber)	458658	—
Pick up, right hand	458367	458367
Pick up, left hand	458368	458368
Brush and spring	451260	451260
Nut, moulded H.T. cable	410600	410600
Washer, pick up seating	458346	458346
Pin and spring securing cover	458613	—
Cover, contact breaker	458619	459269
Brush and contact	—	455190
Cap, breather or baffle	—	459266
Ring, rubber, C.B. cover sealing	—	457681
Screw, terminal, cut out cable securing	458622	—
Screw, contact breaker fixing	492856	492856
Contact breaker	492854	492854
Contacts et	54440888	54440888
Ring, lever retaining	154660	154660
Washer, ring insulating	161673	161673
Screw, spring bracket fixing	100614	100614
Washer, bracket screw insulating	161681	161681
Bush, spring bracket insulating	492853	492853
Bracket, spring supporting	493202	493202
Control parts, set	463107	—
Cover, rubber	454475	—
Plunger, controlling arm	454969	—
Spring, control	454472	—
Nipple, control	455788	—
Screw, adjusting	111591	—
Nut, adjusting screw	170124	—
Cam	458725	459130
Plate, housing contact breaker	458726	54440096
Cup, insulating breaker	451379	451379
Shim, .005" packing C.B. housing	458356	458356
Screw, cam fixing	463931	463931
Pin, cam timing screw	186060	186060
Washer, gear securing nut	140074	—
Nut, securing gear to shaft	170109	—
Armature	459004	459004
Slip ring	455361	455361
Bolt, through fixing	458514	458514
Condenser	458339	458339
Thrower, oil	463944	463944
Collar, bearing retaining	455340	455340
Collar, drive end spacing	455634	455634
Plate, end slip ring	459263	459263
Bearing, contact breaker, end	189291	189291
Bearing, driving end	189244	189244
Seal, oil, bearing	459002	459002
Cup, bearing insulating	459005	459005
Pin and spring, securing pick-up	458370	458370
Brush, spring and holder, earthing	455191	455191
Brush and spring, earthing	455190	455190
Sundry parts set	458675	458675

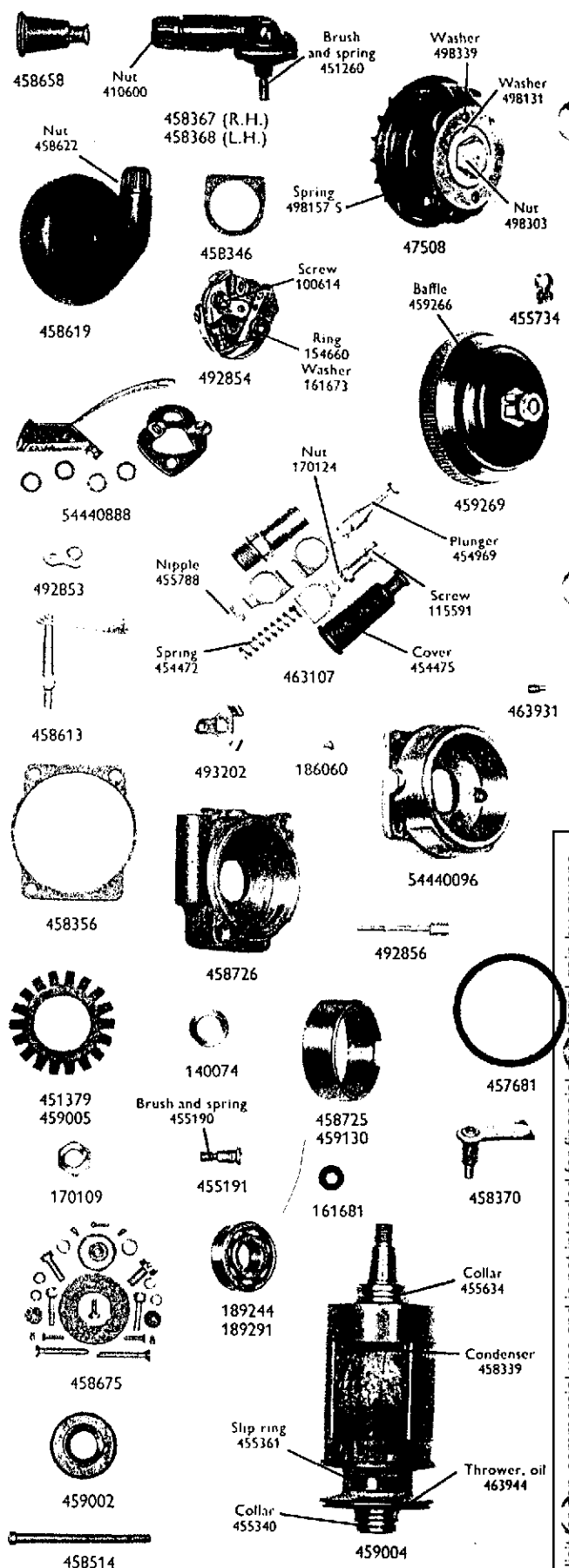

This scan is explicit for non-commercial use and is not intended for financial or material gain by anyone



MAGNETOS

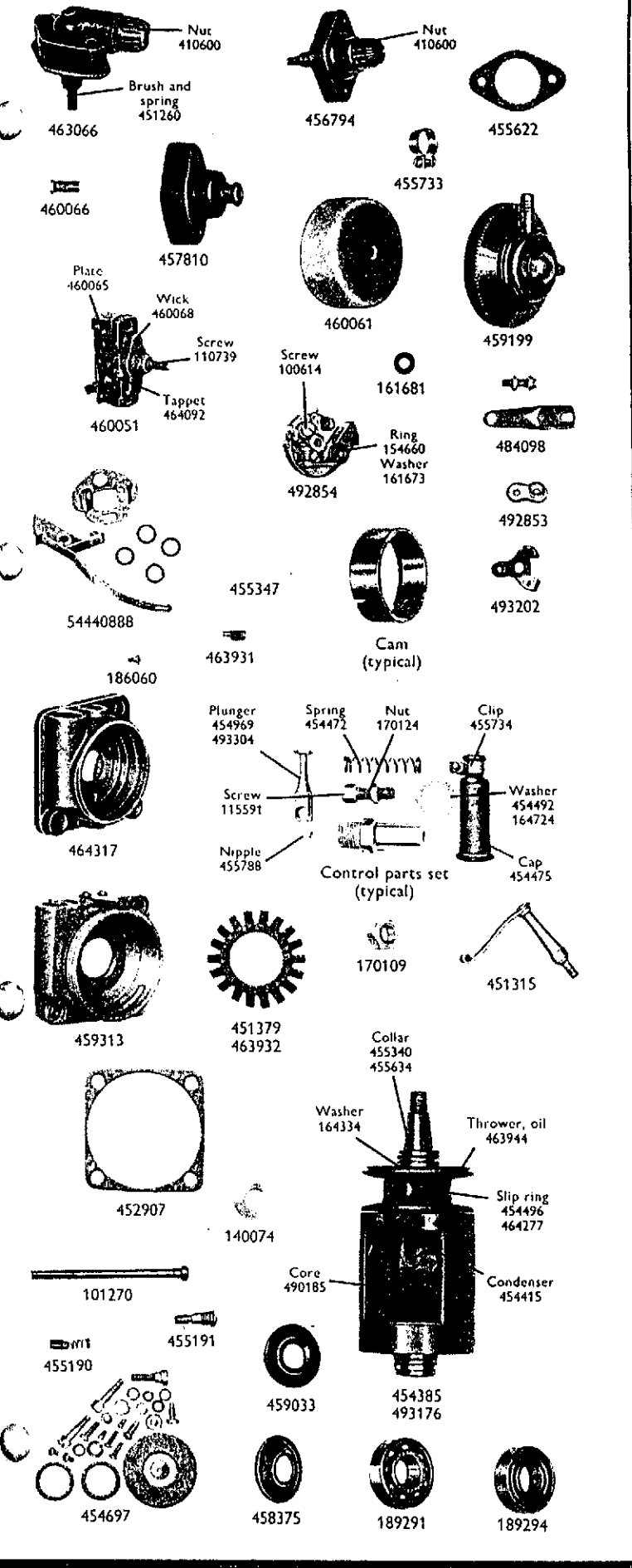

Part No. ... Model ...	42272A/B NI4	42347E NC1
Pick up ...	463066	456794
Brush and Spring ...	451260	451260
Nut, moulded H.T. cable ...	410600	410600
Washer, langite, pick up seating ...	455622	455622
Clip, pick up cover fixing ...	—	455733
Cover, pick up, rubber ...	—	457810
Cover, contact breaker ...	460061	459199
Contact breaker ...	460051	492854
Contact set ...	484098	54440888
Ring, lever retaining ...	—	154660
Washer, ring insulating ...	—	161673
Tappet, celeron ...	464092	—
Screw, hollow, carrier fixing ...	460067	—
Bush, insulating, carrier screw fixing ...	463983	—
Wick, felt, cam lubricating ...	460068	—
Bush, centre insulating ...	460066	—
Plate, carrier to base, insulating ...	460065	—
Screw, contact breaker fixing ...	110739	—
Washer, screw fixing ...	460052	—
Screw, spring bracket fixing ...	—	100614
Washer, screw insulating ...	—	161681
Bush, spring bracket insulating ...	—	492853
Bracket, springs supporting ...	—	493202
Ring, jump, cam fixing ...	455347	—
Cam ...	493178	459321
Screw, cam timing ...	493931	463921
Pin, cam timing screw ...	186060	186060
Control parts, set ...	463107	459005
Nut, cable stop, lock ...	170124	170124
Screw, cable stop ...	111591	111591
Spring, control ...	454472	454472
Washer, barrel locking ...	454494	164724
Barrel ...	454467	—
Plunger ...	454969	493304
Nipple, cable ...	455788	455788
Cap, rubber ...	454475	454475
Clip, cap securing ...	—	455734
Plate, housing contact breaker ...	464317	459313
Cup, insulating breaker ...	451379	463932
Nut, securing gear to shaft ...	170109	170109
Spring and pin ...	451315	—
Shim .005" packing C.B. housing ...	452907	452907
Washer, shaft nut ...	140074	140074
Screw, end plate, seal ...	454694	—
Armature ...	454385	493176
Slip ring ...	454496	464277
Bolt, through fixing ...	101270	101270
Core, wound ...	490185	490185
Drive end ...	456694/S	—
Condenser ...	454415	454415
Condenser box ...	464142/S	—
Thrower, oil ...	463944	463944
Washer, linen ...	164334	—
Collar, spacing ...	455634	455340
Plate and condenser ...	—	464143
Bearing, contact breaker, end ...	189291	189294
Bearing, driving end ...	189291	189294
Seal, oil, bearing ...	—	459033
Cup, bearing insulating ...	451379	463932
Washer, leather, oil excluding ...	458375	—
Brush, spring and holder, earthing ...	455191	455191
Brush and spring, earthing ...	455190	455190
Sundry parts set ...	454697	454697



ALTERNATOR

Part No.	54021027
Model	RM19
Stator	47162A
Clip, cable	54210167
Washer, cable clip	131023
Rotor	54213901

RECTIFIER

Part No.	49072A
Model	2DS506
Nut, fixing	156594

AMMETER

Part No.	36296A
Model	2AR
Nut, terminal	166043
Washer, terminal	185040

COILS, IGNITION

Part No.	45110A/D	45152B
Model	MA12	MA6
Grommet, rubber	421554	421554
Clip, cable contact	421863	421863
Nut, terminal	166043	166043
Washer, shakeproof, terminal	188330	188330
Washer, plain, terminal	131023	131023
Connector, Lucar	54190108	54190108

CONTACT BREAKER UNITS

Part No.	47615A	47617A/B	47618A/B
Model	4CA	4CA	4CA
Contact set	54415803	54415803	54415803
Nut, fixing condenser angle plate	169194	169194	169194
Plate, condenser terminal insulating	425382	425382	425382
Condenser	425377	425377	425377
Plate contact breaker base	425370	425370	425370
Cam	54440029	54441729	54440029
Springs, auto advance (set of 2)	54415640	54413020	54413020
Weights, auto advance	54440031	425359	54440031
Sleeve, and action plate	54415749	425354	54416205

* For reference only, serviced by Rotor and Stator.

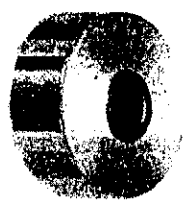

54213901



47162



49072

Nut 156594

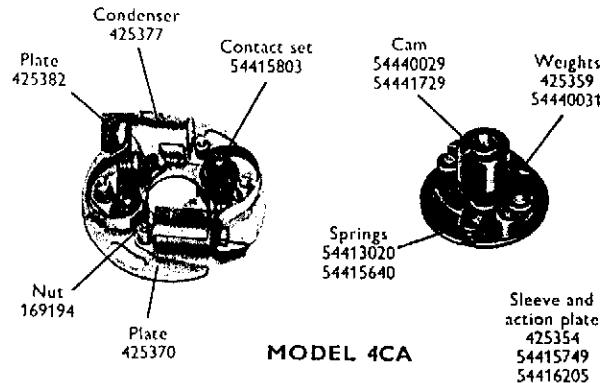

MODEL 4CA

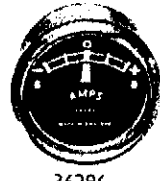

36296

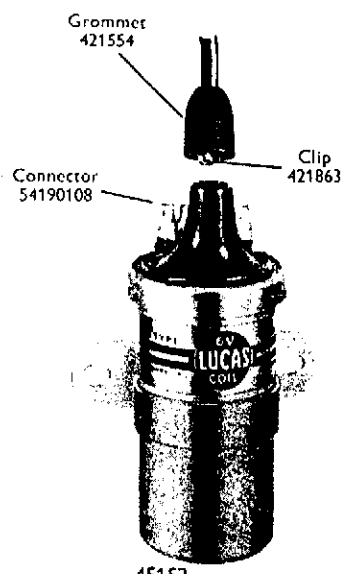

45152
45110 (12 volt)



49345

This scan is explicit non-commercial use and is not intended for financial or material gain by anyone

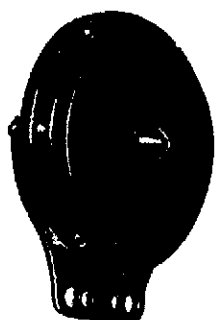

MODEL 6H

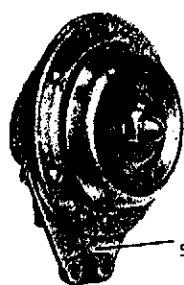

MODEL 8H

Bracket
54680850

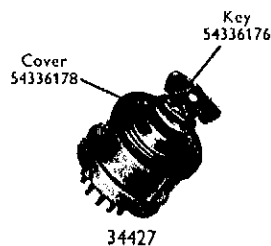
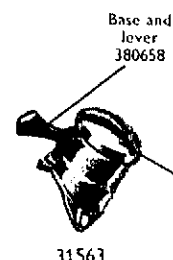
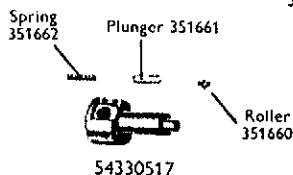
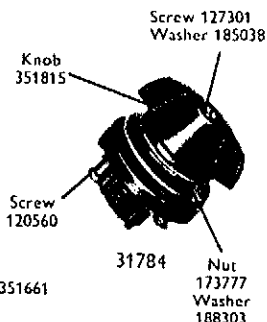
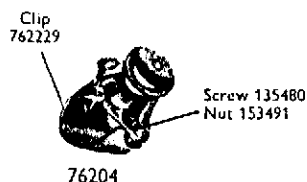

HORNS

Part No.	70159B/D	70197A	70163A/B 70164A/B 8H
Model	6H	6H	
Bracket	—	—	54680850

MAGNETO CUT-OUT SWITCH

Part No.	76204A/D 4A
Screw, terminal	119520
Clip, fixing	762229
Screw, fixing	135480
Nut, fixing	153491

LIGHTING SWITCHES

Part No.	31784A/D 41SA	34289A 88SA
Nut, fixing	173777	180316
Washer, nut fixing	188303	188350
Knob	351815	—
Screw, knob fixing	127301	—
Washer, knob screw fixing	185038	—
Plate, terminal pressure	351807	—
Washer, rubber	351806	—
Screw, terminal	120560	—
Shaft headpiece	54330517	—
Roller	351660	—
Plunger	351661	—
Spring	351662	—
Lever assy. contact	351528	—
Socket with cables	—	†54930007

HORN PUSH AND DIPPER SWITCH

Part No.	31563A 25SA
Button and cover assembly	380660
Base and lever assembly	380658
Screw, terminal	120610

IGNITION SWITCH

Part No.	34427A/B 88SA
Key	54336176
Nut, fixing	54336177
Socket with cables	†54930008

STOP LAMP SWITCHES

Part No.	31383A 22B	31384B 22B	34815A 118SA
Model			

†Order separately



HEADLAMPS

Model MCH61

Part No.	59171A	59172A	59237A 59252A
Model	MCH61	MCH61	MCH61
Rim or door	553248	553248	553248
Wire, light unit fixing	504665	504665	504665
Screw, rim fixing	144921	144921	144921
Plate, rim fixing	534296	534296	534296
Ammeter (see page 8 for details)	36296	36296	36296
Switch, lighting (see page 9 for details)	34289	34289	34289
Knob, with screw, switch	54330934	54330934	54330934
Screw, knob fixing	101371	101371	101371
Washer, dished, screw fixing	332529	332529	332529
Switch, ignition (see page 9 for details)	34427	34427	*34427
Key, ignition	54336176	54336176	*54336176
Cover, PVC	54336178	54336178	*54336178
Light unit	516798	555275	516798
Bulbholder, main	554602	554602	554602
Sleeve, terminal	555910	555910	555910
Bulbholder, pilot	554710	554710	554710
Interior, bulbholder	553780	553780	553780
Ring, bulbholder seating	554354	554354	554354
Washer, cable grip	516285	516285	516285
Bush, rubber	505980	505980	505980
Grommet, trip cable	199001	199001	199001
Screw, lamp fixing	112201	112201	112201
Washer, lamp fixing	137498	137498	137498
Body	54522273	54522273	*54522273
Body (59252A only)	—	—	54522365
Bulb, main	312	403	446
Bulb, pilot	988	988	989

Part No.	59238A 59254A	59173A MCH61	59239A/B 59253A
Model	MCH61	MCH61	MCH61
Rim or door	553248	553248	553248
Wire, light unit fixing	504665	504665	504665
Screw, rim fixing	144921	144921	144921
Plate, rim fixing	534296	534296	534296
Ammeter (see page 8 for details)	36296	36296	36296
Switch, lighting (see page 9 for details)	34289	34289	34289
Knob, with screw, switch	54330934	54330934	54330934
Screw, knob fixing	101371	101371	101371
Washer, dished, screw fixing	332529	332529	332529
Switch, ignition (see page 9 for details)	34427	34427	†34427
Key, ignition	54336176	54336176	†54336176
Cover, PVC	54336178	54336178	†54336178
Light unit	555275	516802	516802
Bulbholder, main	554602	—	—
Sleeve, terminal	555910	—	—
Backshell	—	562303	562303
Bulbholder	—	552943	552943
Clip, with screw	—	555910	555910
Sleeve, terminal	—	562306	562306
Bulbholder, pilot	554710	554710	554710
Interior, bulbholder	553780	553780	553780
Ring, bulbholder seating	554354	554354	554354
Washer, cable grip	516285	516285	516285
Bush, rubber	505980	505980	505980
Grommet, trip cable	199001	199001	199001
Screw, lamp fixing	112201	112201	112201
Washer, lamp fixing	137498	137498	137498
Body	†54522273	54522273	†54522273
Body (59254A and 59253A only)	54522365	—	54522365
Bulb, main	370	—	—
Bulb, main (59254A only)	350	—	—
Bulb, pilot	989	988	989

‡ 59238A only.

* 59237A only.

† 59239A/B only.

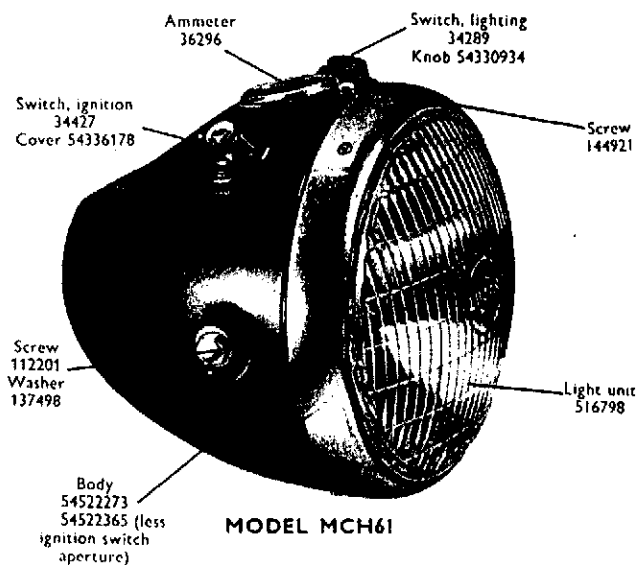

MODEL MCH61

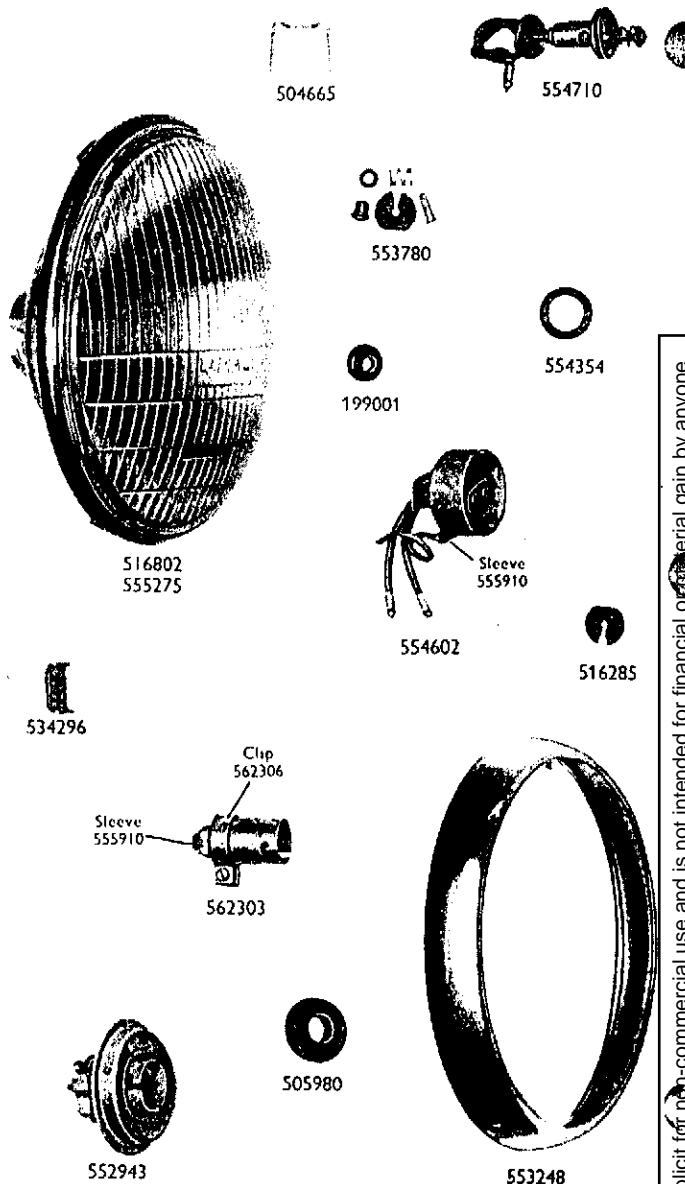

This scan is explicit for non-commercial use and is not intended for financial or commercial gain by anyone



HEADLAMPS

Model SS700P

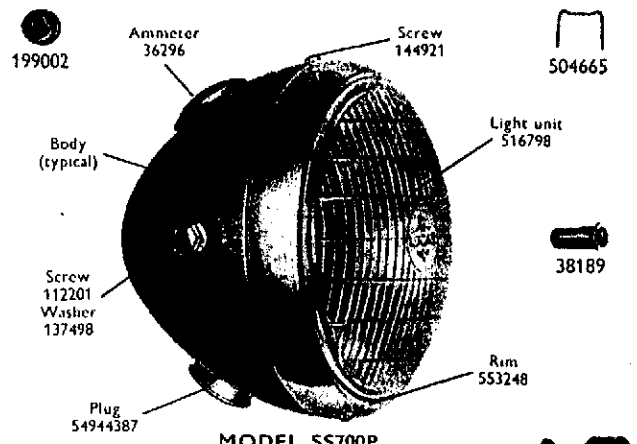

MODEL SS700P

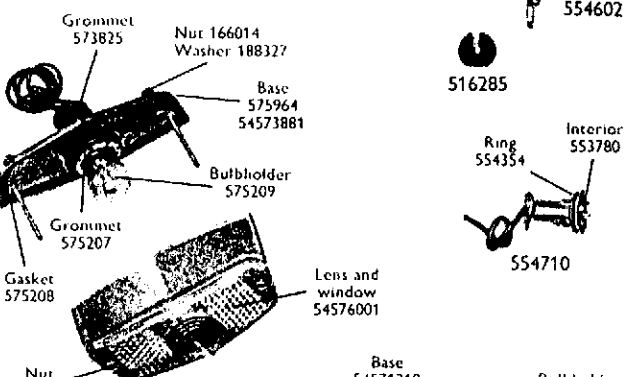

MODEL 564

MODEL 679

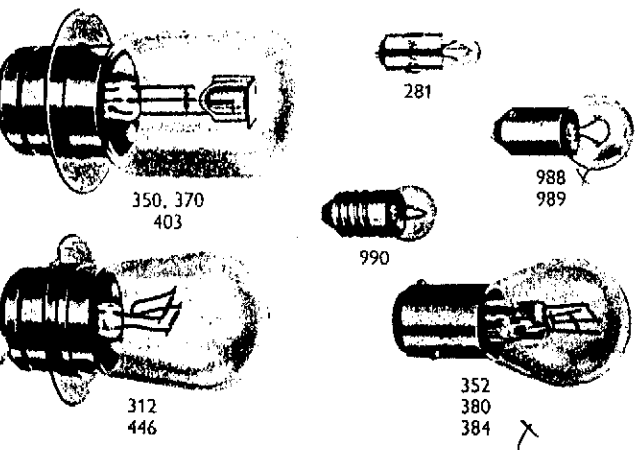

Part No.	58829A/B 59667A SS700P	59281A 59529A SS700P	59666A SS700P
Rim or door	553248	553248	553248
Wire, fixing	504665	504665	504665
Screw, rim fixing	144921	144921	144921
Plate, rim fixing	534296	534296	534296
Ammeter (see page 8 for details)	36296	36296	36296
Warning light body assembly	*38189	—	38189
Sealing washer, Warning light	*54140331	—	54140331
Light unit	516798	516798	516798
Bulbholder, main	554602	554602	554602
Sleeve, terminal	555910	555910	555910
Bulbholder, pilot	554710	554710	554710
Interior, pilot	553780	553780	553780
Ring, bulbholder seating	554354	554354	554354
Screw, lamp fixing	112201	112201	112201
Washer, lamp screw fixing	137498	137498	137498
Grommet, cable entry	199002	—	—
Plug with cable	54944387	—	—
Screw, plug fixing	133303	—	—
Nut, plug screw fixing	166103	—	—
Washer, screw fixing	188412	—	—
Ring, plug retaining	516409	—	—
Washer, cable grip	516285	516285	516285
Connector, single	900288	—	—
Nipple, cable	900289	—	—
Body	*54523254	†54522377	54523347
Body (58829A/B only)	54521617	—	—
Body (59529A only)	—	54521793	—
Bulb, main	312	446	446
Bulb, pilot	988	989	989

STOP TAIL, REFLEX AND NUMBER PLATE LAMPS

Part No.	53432B/D 564	53454B/D 564
Lens and window	54576001	54576001
Nut, barrel, lens fixing	575219	575219
Gasket, lens seating	575208	575208
Base	54573881	575964
Grommet, bulbholder	575207	575207
Bulbholder	575209	575209
Interior, bulbholder	573828	573828
Grommet, cable entry	573825	573825
Nut, lamp fixing	166014	166014
Washer, shakeproof	188327	188327
Washer, spacer fixing bolt	131023	131023
Bulb	384	380

Part No.	53972A/B 679	53973A/B 679
Lens	54572932	54572932
Screw, fixing lens	572289	572289
Bulbholder, with reflector	54574348	54574348
Interior, bulbholder	573828	573828
Base	54571319	54571319
Gasket, lamp seating	54571677	54571677
Screw, lamp fixing	127684	127684
Washer, screw fixing	188483	188483
Bulb	384	380

BULBS

Part No.	Volt	Watts	Description
281	12	2.0	Coil, Sub miniature
312	6	30/24	Transverse, vertical dip
350	12	34/35	Transverse, vertical dip
352	6	18/3	Transverse, offset pin
370	12	45/40	Transverse, vertical dip
380	12	21/6	Transverse, offset pin
384	6	18/6	Transverse, offset pin
403	6	35/35	Bow, hooded axial
446	12	50/40	Transverse, vertical dip
988	6	3	Coil, miniature bayonet cap
989	17	6	Coil, miniature bayonet cap
990	6	3	Coil

* 59677A only. † 59281A only.

This scan is explicit for non-commercial use and is not intended for financial or material gain by anyone