

ROSE BROTHERS (FELIXSTOWE) LTD.,

FELIXSTOWE.

*For the man who
buys the best.—*

A.J.S.
Motor Cycles

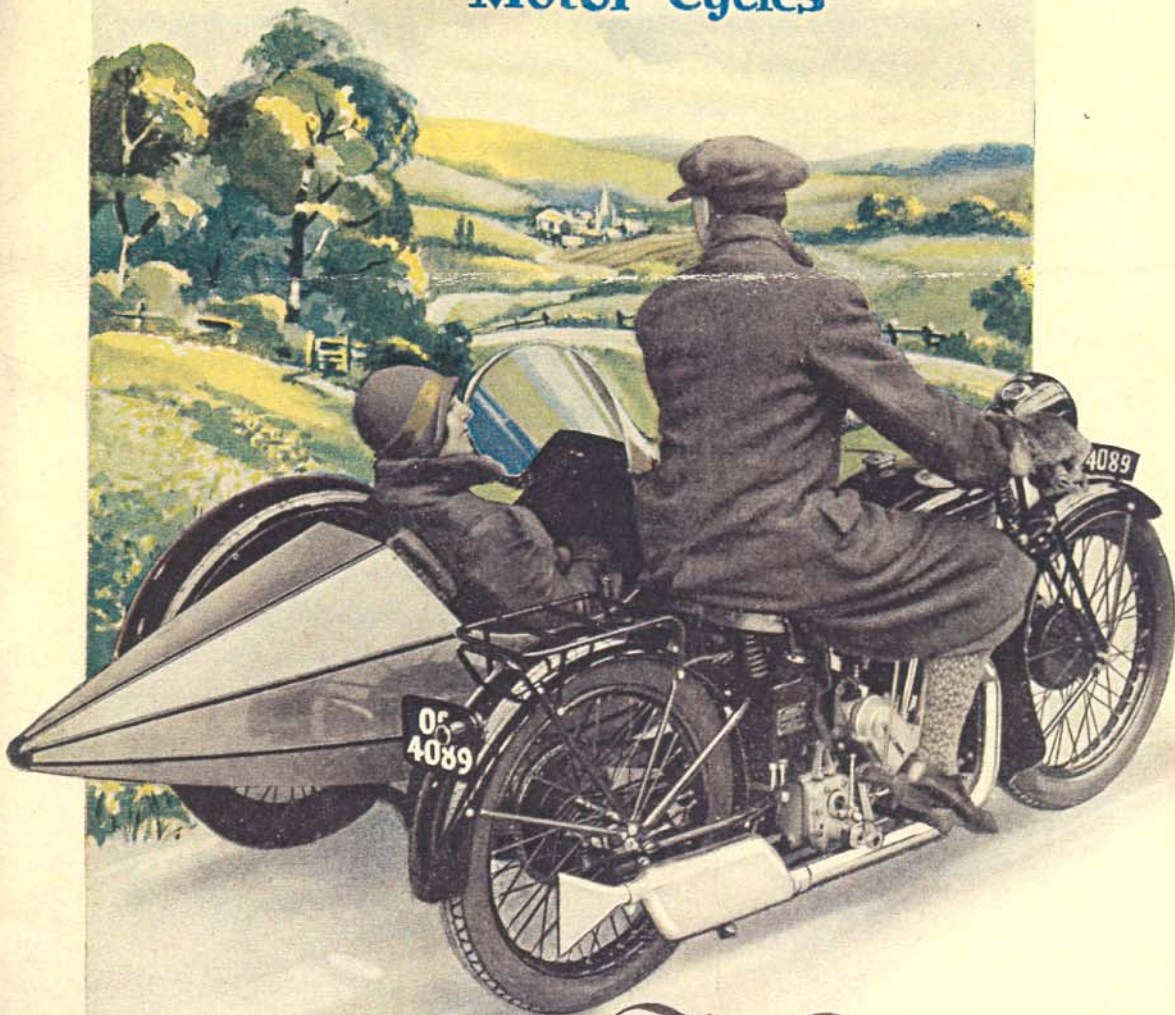

— The Reason Why —

Introductory



HERE is no Royal Road or any short cut to the attainment of Perfection. The Best, in anything and everything, is always the result of evolution, development and accumulative experience.

When you want the Best you buy from those people whom you know have long experience, and have evolved and developed their products during a period of many years. A.J.S. have been designing and manufacturing engines and motor cycles since 1897!

Right from the commencement of the motor cycle industry they have been pioneers in design, and were the originators of many features which are now incorporated in the modern motor cycle; for instance, all chain drive and a three speed countershaft gear box were fitted as long ago as 1905 — a hand controlled clutch in 1910 — a kickstarter and detachable cylinder head in 1911 — internal expanding brakes and quick detachable wheels in 1914, and so on. Accumulated Experience — Evolution — Development — for 33 years.

With all this experience A.J.S. should be able to produce motor cycles of more than ordinary merit. THEY CAN and THEY HAVE — for the 1930 A.J.S. models embody all the features long desired by all motor cyclists of every type, and provide the realization of the Ideal — Practical Perfection — and are THE Best.

The Utility of a Motorcycle



HE popularity of Motor Cycles has increased and is still increasing; Why? That question has innumerable answers which can all be covered by one word—Utility.

Motor Cycles are Safer Than Ever—Better Than Ever—Cheaper Than Ever. Their usefulness appeals to everybody, and their low prices bring them within the reach of almost everyone. Motor Cycles provide the cheapest, handiest and easiest means of transport for any and every purpose, whether business, pleasure or sport. Running costs are the lowest of all road vehicles, the minimum of care and attention only is required, there are no parking difficulties, and other obvious advantages too numerous to detail here.

Motor Cycles provide exhilaration, recreation and health. They give the freedom of the road leading to the glorious countryside and the sea. They enable the worker in the city to get the fresh air and sunshine he craves and needs with the least trouble and the least cost.

Motor Cycles give an independence of the time-table and dispense with the deadly necessity of travelling in crowded and stuffy trains, trams or buses. To enjoy all these advantages to the full your mount must be the Best, and that is what we claim the A.J.S. to be.

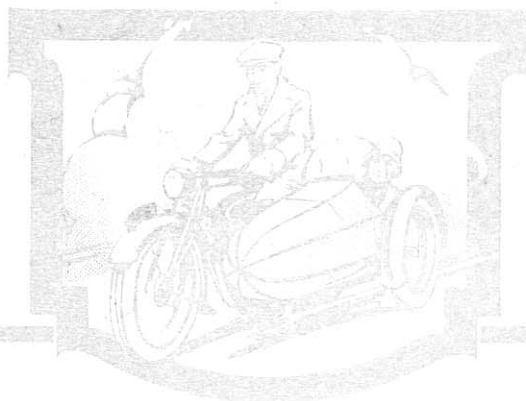

Every Prospect Pleases

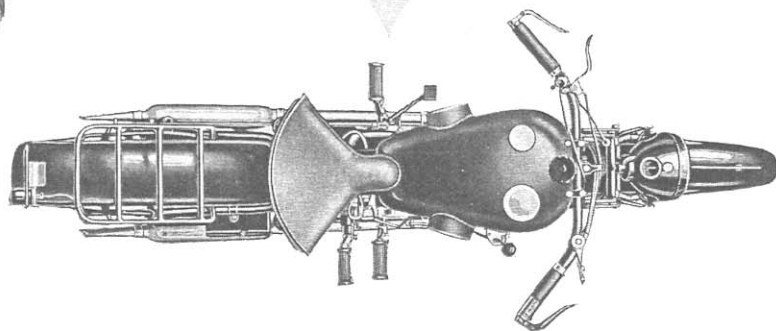
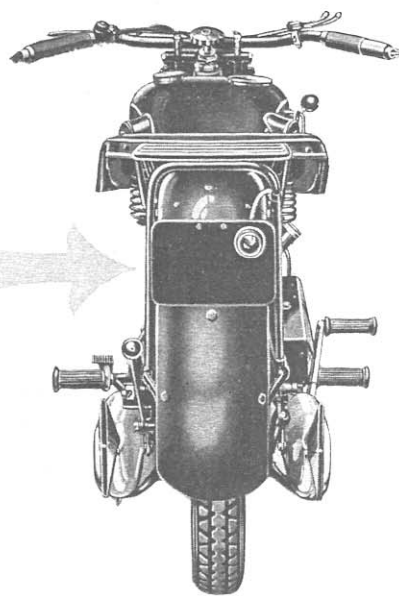
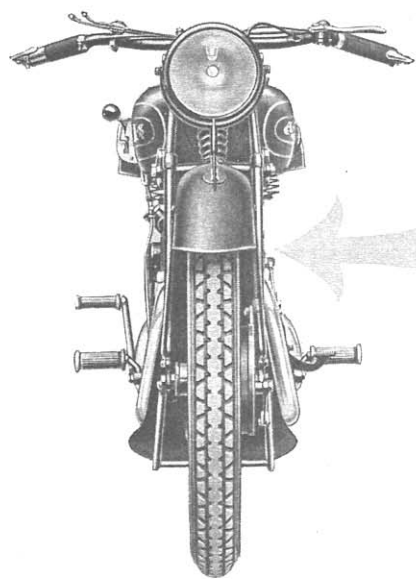
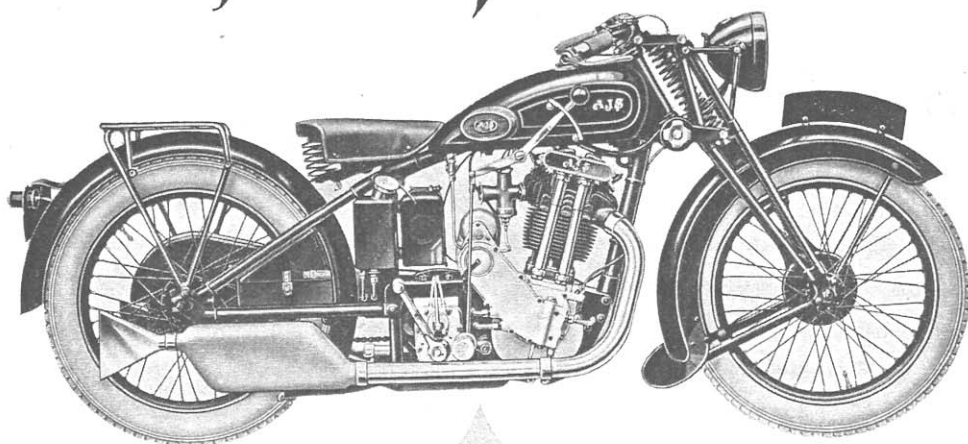

LOOKED AT FROM
ANY ANGLE
THE
A.J.S.
LOOKS GOOD!

The Result of Research and Experiment

IN the 1930 A.J.S. Models the rider will truly find a motor cycle that will not only satisfy him from the point of speed, acceleration and appearance, but will delight him with its smooth running, flexibility, perfect road holding qualities at any speed, ease of steering and mechanical quietness.

The new Models fully retain the merits of A.J.S. quality that has existed from year to year. All who are conversant with previous Models know exactly what this means. To-day A.J.S. leadership prominently asserts itself with machines which in design, specification, performance and value, are years ahead of all competitors.

The 1930 A.J.S. Models are the result of the invaluable experience gained in compiling the huge total of 117 World's Records which the A.J.S. made in 1929, and also in achievements in the most important European Grand Prix Races and big International Reliability Trials. Breaking World's Records undoubtedly provides the most strenuous and exacting test to which an engine can be subjected, therefore, as the essential design features of the 1930 engines are identical with those used in breaking these World's Records, their absolute dependability and efficiency is assured. Experience designed the 1930 A.J.S. machines, experience proved and tested them, and experience dictated their numerous improvements and refinements. In short the 1930 Models show enormous advancement in design, mechanical efficiency and completeness of specification.

The A.J.S. has always rigidly adhered to the policy of refusing to build a motor cycle down to a price, but rather to

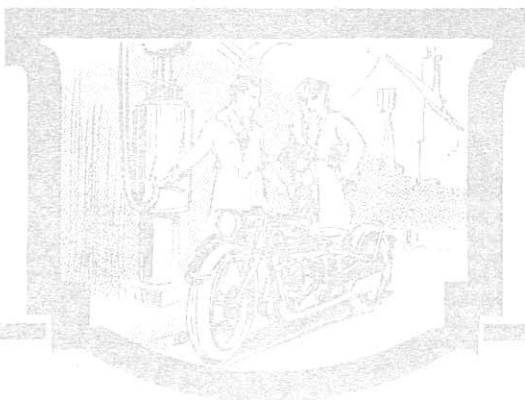

build up to the highest possible standard of excellence—thereby creating confidence amongst its tens of thousands of devotees.

Some Features of the **A.J.S.**

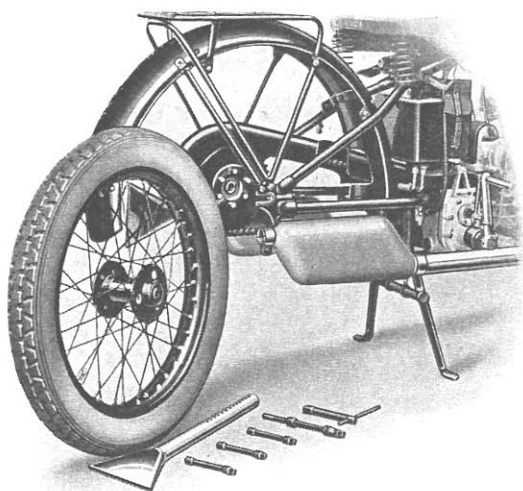

The Quick Detachable Rear Wheel

The simplicity of operation of this most desirable feature of A.J.S. machines is illustrated in this picture. It will be seen that three sleeve bolts, a centre pin and a distance piece are all that have to be removed to enable the wheel to be drawn off the driving sprocket—nothing else is touched—chain and brake adjustment remain unaltered, likewise wheel alignment is undisturbed. No more simple or efficient detachable wheel is to be found on the market.

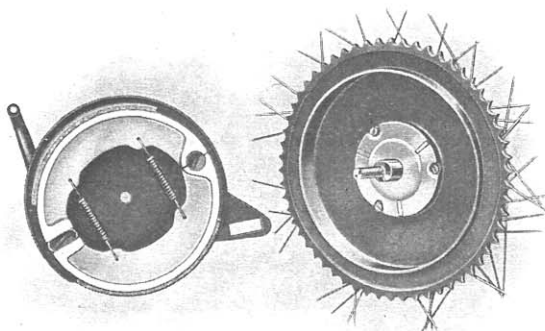

Internal Expanding Brakes

Here again the lowest priced A.J.S. models are replicas of the more expensive ones, for both front and rear brakes are of the internal expanding type, which afford a security and safety not otherwise obtainable. The A.J.S. brake work has always been famous for effectiveness and smoothness of operation. 1930 brakes have all been improved—larger diameter drums and shoes, and stouter anchorage being embodied.

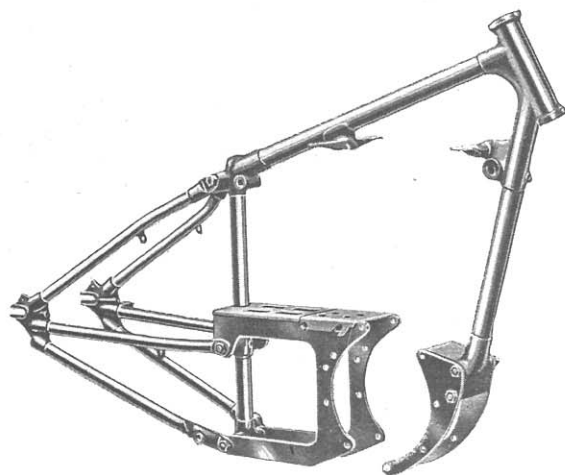

Semi-Cradle Type Frame

The 1930 A.J.S. frame is a masterpiece of scientific design and construction. It is of semi-cradle type with torque tubes to the fork ends, which absorb all torsional stresses of the transmission. It will be seen that the bottom bracket and rear engine plates are in one piece, thus affording great rigidity and strength. Note also how the seat pillar tube is continued down to the lower cradle plates and torque tubes. A single rail only is employed for the top tube, this being $1\frac{1}{2}$ in. diameter, and the same dimensions are used for the front member. The seat tubes are $1\frac{1}{2}$ in. diameter wide, and chain stays 1 in. diameter on the 500 c.c. models and $\frac{3}{4}$ in. diameter on the 350 c.c. models.

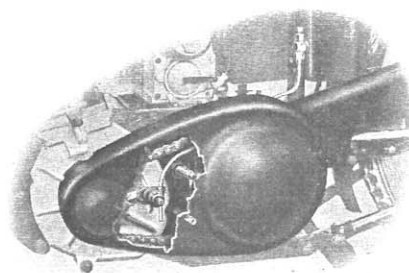

Mechanical Oil Feed to Front Chain

This illustration shows a refinement which is standard on all 1930 A.J.S. models. Oil is fed to the primary chain from the main supply tank, and adjustment is controlled by a needle valve. The oil feed starts and stops with the engine.

A.J.S. Features Continued.

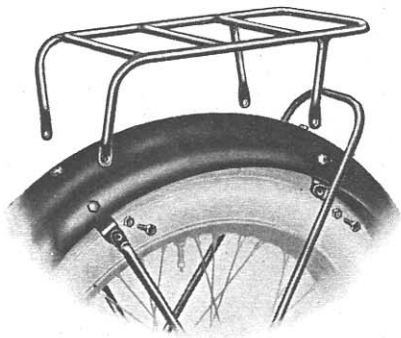

The Detachable Rear Carrier

Special provision has been made on certain of the 1930 A.J.S. models for the removal of the rear carrier. This is accomplished by the simple means shown in the illustration which needs little explanation. Four pins and nuts only have to be removed and the carrier can be lifted off, leaving the rear mudguard clear, at once conforming to the sporting appearance which so many riders prefer. The carrier is made of finest quality steel tube, oxy-acetylene welded.

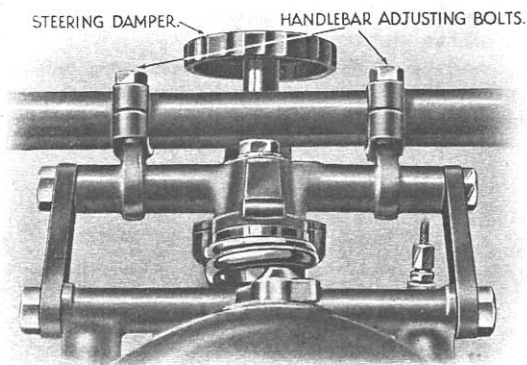

Adjustable Handlebars & Steering Damper

Every 1930 A.J.S. model is fitted with adjustable handlebars and steering damper which allow the rider to suit these to his own individual requirements. Even the very cheapest models are so equipped, so that if your choice falls on one of the £40 machines you will not be inferior to the more expensive models in this respect.

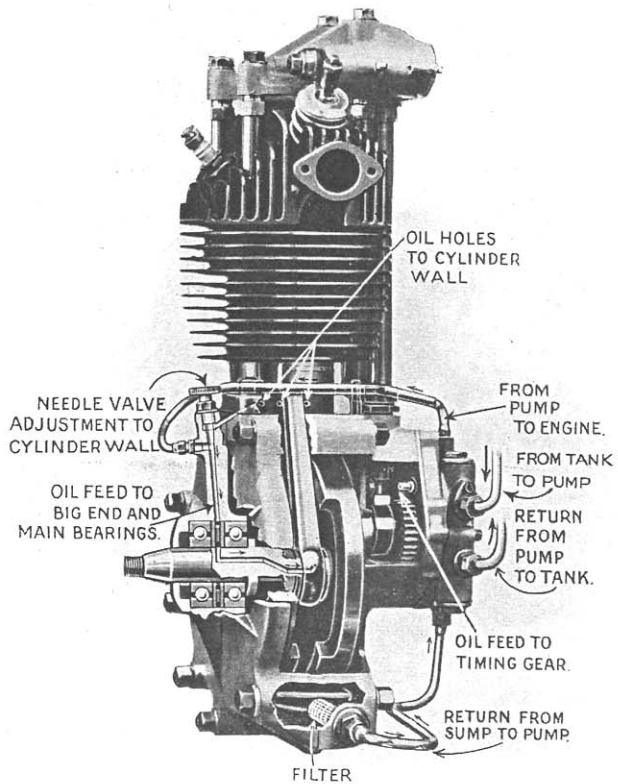

Patent Dry Sump Lubrication

The day of the "hit and miss" lubrication was relegated to the past when we introduced our proved and perfect dry sump system. Mention is made elsewhere of this exclusive A.J.S. feature, and the above illustration shows the circulation of the oil which is by means of a double acting pump driven by the half time shaft. The feed side of this pump forces oil to the main bearings and thence by oil-way to the big end. Oil is also forced to the timing gear case, lubricating all gears, cams, and bearings. All oil pumped to the engine afterwards drains to the sump, from whence it is drawn by the other half of the pump and returned to the tank.

With this patented system of lubrication the rider has the satisfaction of knowing that a continuous flow of cool oil is passing through his engine to suit every condition of road or load.

A.J.S. Features Continued.

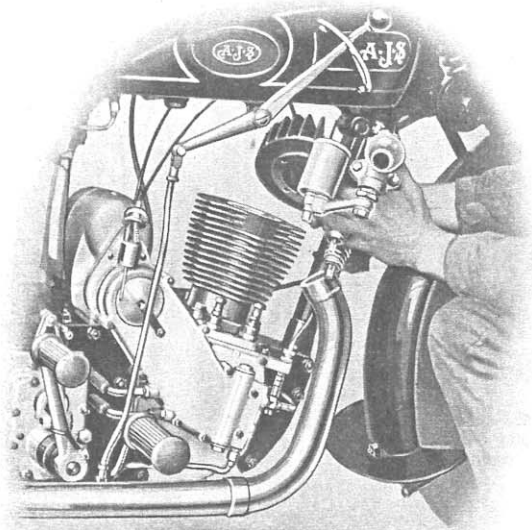

The Detachable Cylinder Head

Simplicity and accessibility are again the keynotes here—see how ample room is afforded for drawing off the cylinder head, and note also that one spanner only is needed to unfasten the holding down bolts.

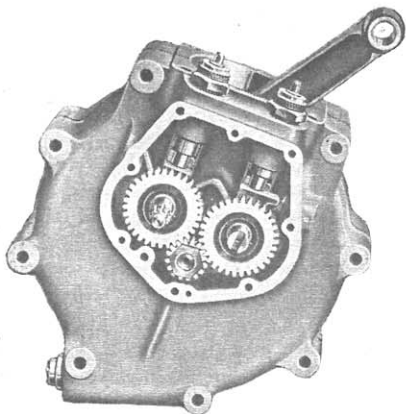

Sturdy Crank Case & Simplified Valve Timing.

The crankcase is a beautiful piece of workmanship made of fine quality die cast aluminium, heavily ribbed round the main bearings and strengthened at all vital points. Like the cylinder head this is again the outcome of our experience in racing and record making. In this view the simplicity of the timing gear to the single cylinder engine is strikingly illustrated. There are three timing pinions only and no rockers are employed, thus reducing the moving parts, with a consequent gain in efficiency and silence. The main shafts of all the 1930 A.J.S. engines are mounted on ball bearings, a double row on the driving side and a single row on the timing side. The big end itself is mounted on a double row of caged roller bearings of special design, evolved from our racing experience

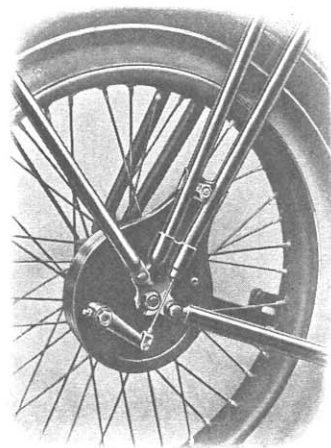

Front Brake Operation and Improved Anchorage

A novel feature of the 1930 A.J.S. models is the method of fitting the front brake operating cable. This passes through the front fork blade and is thus completely enclosed, except for the small portion which protrudes where it is attached to the operating lever. Adjustment for the Bowden cable is provided on the top of the forks.

The neatness of this fitment will be apparent from the accompanying illustration, also the improved anchorage should be noted.

The Choice of a Machine

Why an **A.J.S.**

THE potential buyer of a motor cycle should consider quite a number of factors when making his choice, to ensure that he will get the best possible value for his money. Those factors, which fully explain themselves, are given briefly herewith.

Buying the product of a manufacturer with a Reputation and undeniable Experience.

Economy.

Specification and Equipment.

Constructional Simplicity and Accessibility.

Easy Maintenance and Upkeep.

Appearance compatible with Comfort.

Achievements of Speed and Reliability.

Service.

Popularity.

Consider these Factors in the 1930 A.J.S. Models.

Experience.

A.J.S. have been manufacturing motor cycles since 1897 and have a Reputation second to none.

Economy.

Design, Workmanship and Materials in A.J.S. motor cycles are of the highest possible grade, yet the prices are the lowest possible consistent

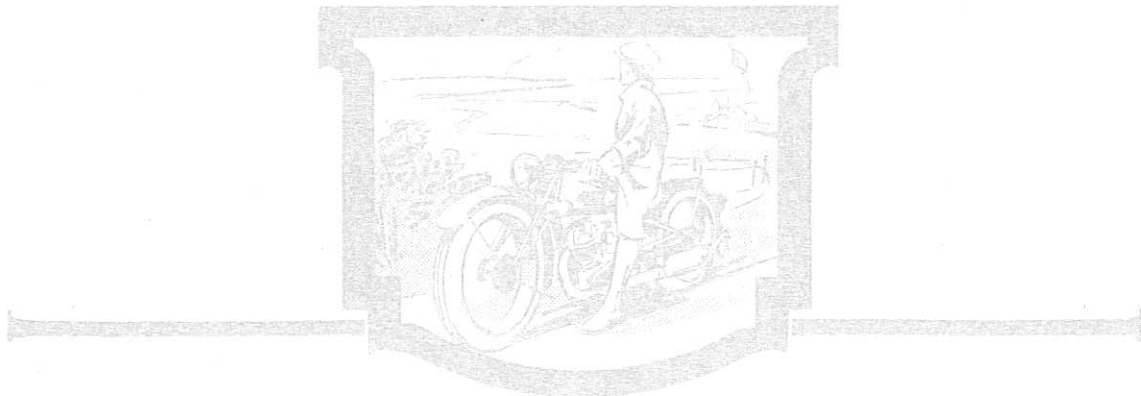

The Choice of a Machine *Continued.*

with this Standard of Quality. Economical running costs are the natural outcome of this excellence of Design and Quality.

The Depreciation of Value of an A.J.S. is extraordinarily small and its second hand value is always maintained at a very high level.

Specification and Equipment.

In choosing a motor cycle, careful comparison of specifications and equipment should be made. Study the specifications of the 1930 A.J.S. models and it is obvious that the utmost care has been used to satisfy the discriminating motor cyclist's requirements. Special attention should be given to the numerous outstanding features detailed in our catalogue.

Constructional Simplicity and Accessibility.

Constructional simplicity and accessibility have always been noteworthy features of A.J.S. motor cycles, and undoubtedly these appeal very strongly to both the novice and the expert.

Easy Maintenance and Upkeep.

A.J.S. motor cycles require the minimum of care and attention, and because of the simplicity of design and excellence of workmanship and material it is not necessary for owners to be expert mechanics.

Decarbonising, adjustments, etc., are easily dealt with even by the novice rider. Cost of upkeep is negligible—A.J.S. is synonymous for Durability—and replacement of parts is most infrequently necessary.

Appearance and Comfort.

One has only to glance at a 1930 A.J.S. motor cycle to be immediately impressed with the clean, symmetrical lines and handsome appearance.

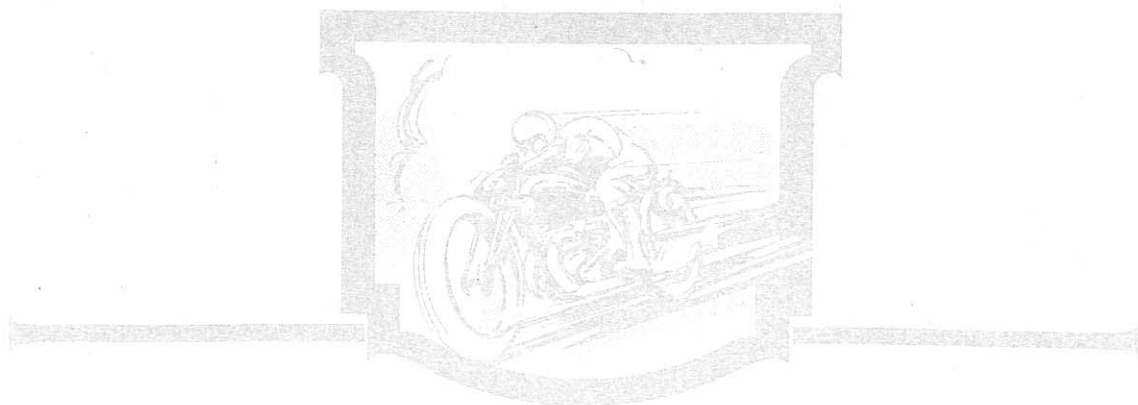

The Choice of a Machine *Continued.*

There is no suggestion in it's appearance that various parts have been added as an afterthought. It's appearance indicates in every line that it has been built by expert engineers of more than ordinary experience and skill.

Comfort, too, is obvious from the first glance—the low saddle position, the natural position of the handlebars and footrests, and the large tyres. The saddle, footrests and handlebars are all adjustable, so that comfort is assured for every rider.

Speed and Reliability.

A.J.S. have competed in Road Races and Reliability Trials with marked success and in addition have broken 117 World's Records. The value of all these successes lies, not in the successes themselves but in the experience gained which enables us to embody improvements in material and design.

1930 A.J.S. models are both Reliable and Speedy.

Service.

Even an A.J.S. requires replacement parts at some time or other. Effective After-sales Service can be obtained from our Dealers in practically every part of the World.

Popularity.

A.J.S. motor cycles are ridden and praised by satisfied owners in ever increasing numbers all over the world. This popularity is sure proof of the satisfaction given by A.J.S. motor cycles.

Be guided by the satisfaction of others and you also will become a satisfied A.J.S. owner.

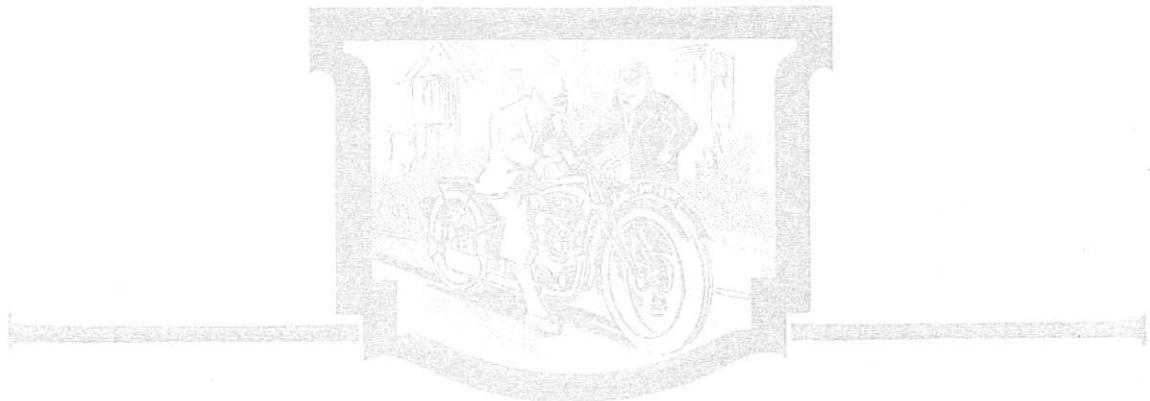

The Choice of a Machine *Continued.*

The Advantages of A.J.S. Motor Cycles.

Quick Detachable Rear Wheel.

Whatever motor cycle you buy, there is always the possibility of a puncture, or the need to fit a new cover or tube.

In the case of most motor cycles you would find it necessary to put in some hard and dirty work, taking off chaincases, chain, brake anchorage, brake rod, silencers, etc., and after repairing the puncture, reassembling all these parts and lining up the wheel, which in itself is no easy matter. But NOT if your machine is an A.J.S. The A.J.S. Quick Detachable Rear Wheel can be detached in one minute without disturbing the brake, chain, or any other part, and further the inner tube can be taken out and replaced without detaching the wheel at all. Ask your dealer for a demonstration.

Patent Dry Sump Lubrication.

With the A.J.S. lubrication system there is a constant circulation of oil to all parts of the engine. The only attention necessary being to keep the oil tank full. This system has been tested over a number of years and has proved to be both perfectly reliable and economical. It is far in advance of any other method of lubrication and is The Perfect System.

Crankcase Construction.

The crankcase clearly indicates the careful attention that has been paid to every detail in design. Its sturdiness provides great strength at the vital parts, giving the rigidity which ensures smooth running and perfect balance.

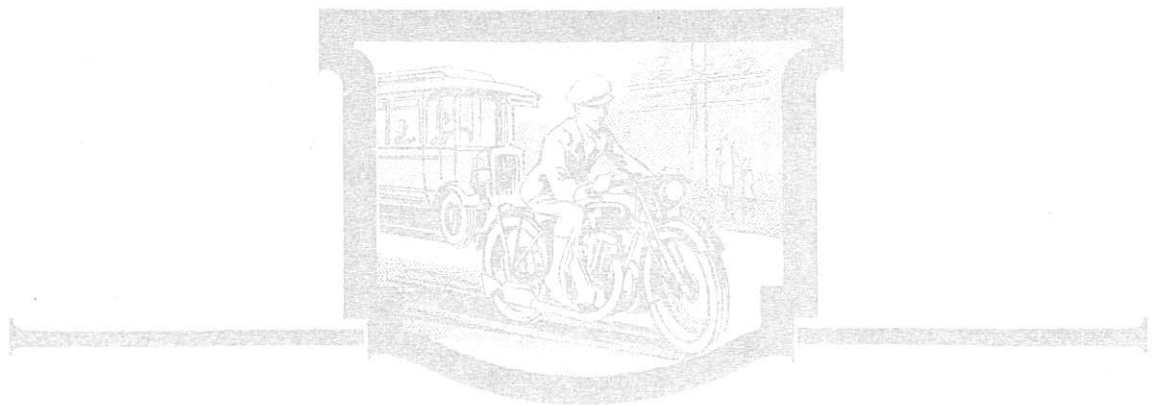

The Choice of a Machine *Continued.*

The Advantages of A.J.S. Motor Cycles.

Mechanical Oil Feed to Primary Chain.

This method gives a positive and controllable supply of oil to the primary chain, thus assuring constant lubrication and consequent longer life of the chain. A feature of this is that the oil feed is only in operation when the engine is running and automatically stops with the engine.

Gearbox and Footstarter.

Gear changing is extremely easy with the constant mesh gears of the 1930 A.J.S. gearbox, while the multiple plate clutch ensures sweet and effortless action. A very efficient shock absorber is embodied in the clutch which gives perfectly smooth transmission at all speeds. The footstarter mechanism is enclosed, affording protection to the working parts, and is absolutely quiet in operation.

Patent Taper Roller Bearing Hubs.

This type of hub is far more efficient than any other. It has exceptionally long life, and requires an absolute minimum of attention and adjustment.

Finger Adjustment to all Controls.

All controls, brakes, clutch, carburettor, etc., can be adjusted instantly by hand without recourse to the tool kit.

We have mentioned but a few of the many advantages possessed by A.J.S. motorcycles, but we suggest that they are sufficient to convince you that—YOUR CHOICE SHOULD BE AN A.J.S.

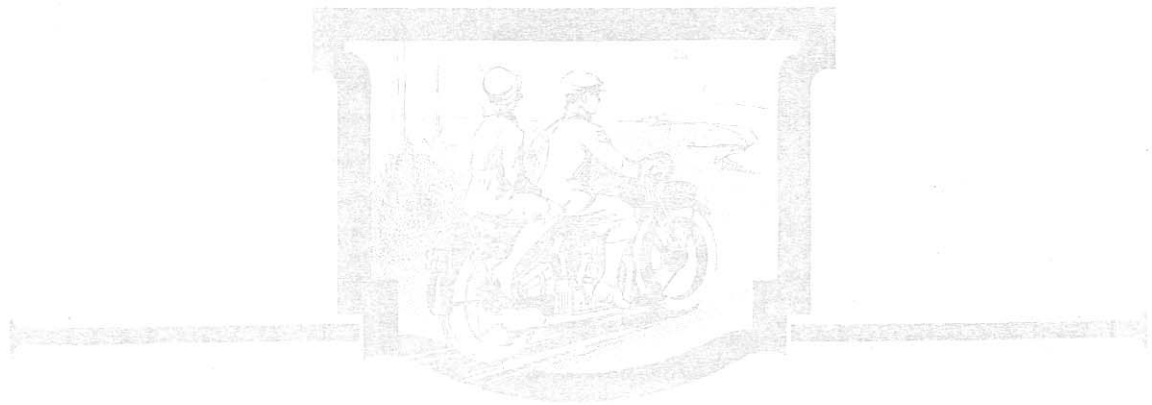

A Model for Every Purpose.

The purchase of a motor cycle need present no difficulty to the prospective owner, for any A.J.S. model can be obtained out of income on our very attractive instalment system. A few examples of the easy terms upon which it is possible to acquire an A.J.S. are illustrated below, but full details of every model and sidecar are sent out with every application for a Catalogue.

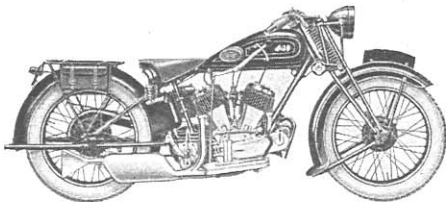

A.J.S. 9.96 h.p. Twin Cylinder, Model R 2, £63.

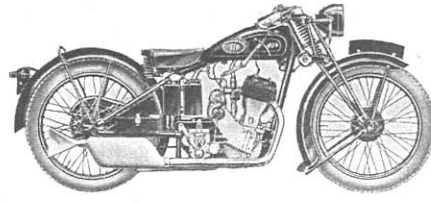

A.J.S. 3.49 h.p. de Luxe Side Valve, Model R 4, £44 : 10.

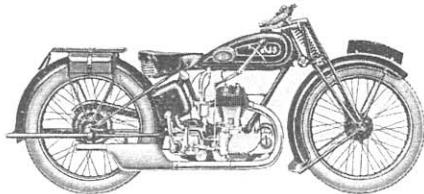

A.J.S. 3.49 h.p. Standard Lightweight, Model R 5, £40.

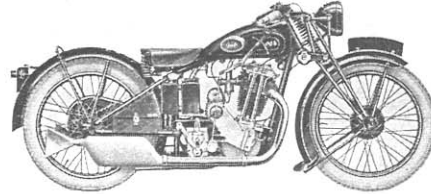

A.J.S. 3.49 h.p. O.H.V. Two Port, Model R 6, £53.

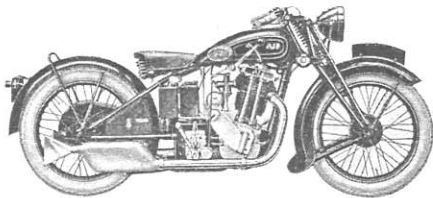

A.J.S. 4.98 h.p. de Luxe O.H.V. Two Port, Model R 8, £59 : 10.

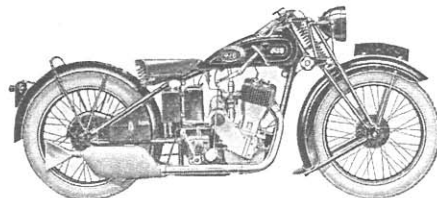

A.J.S. 4.98 h.p. de Luxe Side Valve, Model R 9, £52 : 10

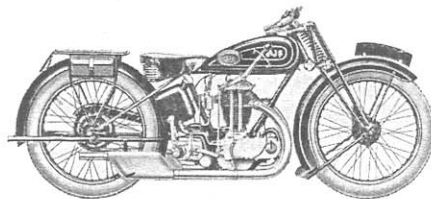

A.J.S. 2.48 h.p. O.H.V. Two Port, Model R 12, £40.

Examples of Hire Purchase Terms

H.P.	MODEL	List Price			Deposit			12 Monthly Payments excluding Insurance
		£	s.	d.	£	s.	d.	
9.96	R 2 Solo Twin Cylinder Machine	63	0	0	15	15	0	4 6 8
3.49	R 4 Solo De luxe Side Valve Machine	44	10	0	11	2	6	3 1 6
3.49	R 5 Solo Standard Lightweight Touring Machine	40	0	0	10	0	0	2 15 10
3.49	R 6 Solo De Luxe Overhead Valve Machine (Twin Port)	53	0	0	13	5	0	3 12 11
4.98	R 8 Solo De Luxe Overhead Valve Machine (Twin Port)	59	10	0	14	17	6	4 1 10
4.98	R 9 Solo De Luxe Side Valve Machine	52	10	0	13	2	6	3 12 2
2.48	R 12 Solo De Luxe Overhead Valve Machine (Twin Port)	40	0	0	10	0	0	2 15 10

Some 1929 Achievements

The 500 c.c. A.J.S. is the only machine that has covered 1,000 miles in 12 hours.

119.76 m.p.h. officially attained over the flying mile, one way, at Arpajon, August 25th, 1929, thus proving the 500 c.c. A.J.S. to be the fastest single cylinder motor cycle in the world.

Winner of 200 Mile Race at Brooklands, 350 c.c. class.

Winner of 200 Mile Sidecar Race at Brooklands, 350 c.c. class.

92.87 m.p.h. for Three Hours, set up on 350 c.c. A.J.S. 800 miles in 12 hours, made by the 350 c.c. A.J.S. and Sidecar.

117.8 m.p.h. for 5 miles made by the 500 c.c. A.J.S.

84.06 m.p.h. averaged for One Hour by 350 c.c. A.J.S. and Sidecar.

The A.J.S. has broken more World's Speed Records in one season than any other motor cycle in the world.

The longest road race in the World (Durban-Johannesburg) won by the A.J.S. Also second, eight, ninth and thirteenth places.

Australian T.T. A.J.S. First and Second in the Senior Race and Second in the Junior Race.

German T.T. A.J.S. First in the 350 c.c. class, and Fastest Lap.

Junior T.T., I.O.M. A.J.S. Second.

Ulster Grand Prix. 350 c.c. class. A.J.S. First, Second and Fourth.

Danish Grand Prix. A.J.S. First and Second.

Austrian Grand Prix. 350 c.c. class. A.J.S. First.

Grand Prix of Europe, 350 c.c. class. A.J.S. First, Second and Fourth



WHERE **A.J.S.** MOTOR CYCLES ARE MADE

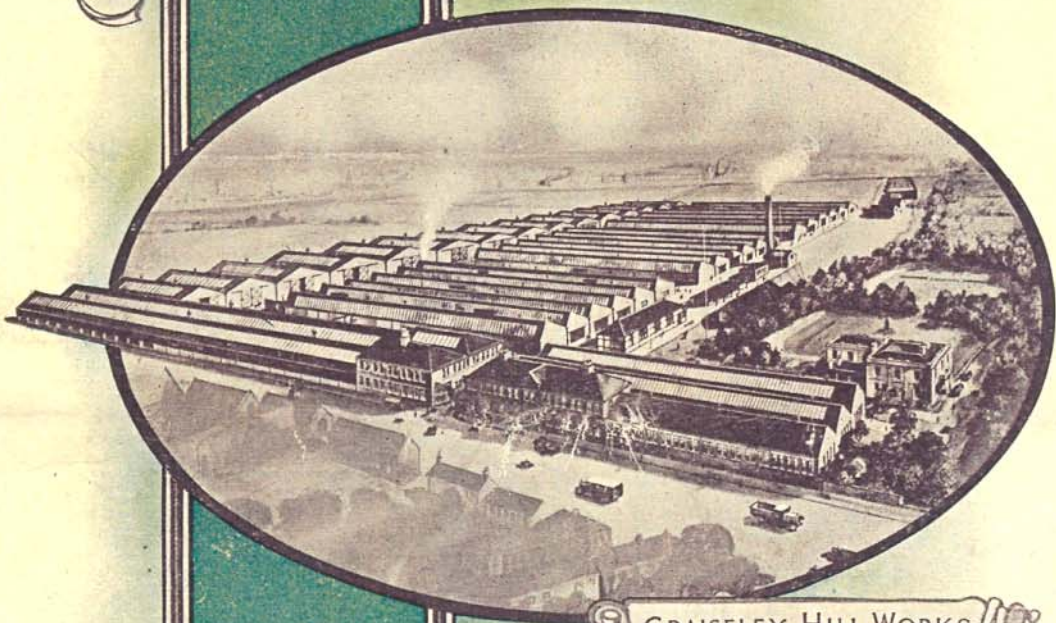

GRAISELEY HILL WORKS,
WOLVERHAMPTON.

A. J. STEVENS & CO. (1914) LTD.,
WOLVERHAMPTON.

Telephone : 1731 (Seven Lines). Telegrams : "HOPIT, WOLVERHAMPTON."

Codes :
BENTLEY'S. MARCONI INTERNATIONAL.
A.B.C. 5TH AND 6TH EDITIONS.