

LUCAS EQUIPMENT FOR 1963 BRITISH MOTOR CYCLES

CONTENTS

	<i>Page</i>
Alternator and Parts	18
Ammeter	9 and 11
Battery	15
Bulbs	16-17
Contact Breaker Unit and Parts	6-7
Control Box and Parts	8 and 10
Distributor and Parts	6-7
Generator and Parts	4-5
Headlamp and Parts	10-13
Horn and Bracket	8 and 10
Ignition Coil	7
Magdyno and Parts	4-5
Magneto and Parts	2-3
Motor Cycle Model Reference	21
Motor Cycle Wading Magnetos	20
Reflex Reflector	15
Side Lamp and Parts	16-17
Starter and Parts	4-5
Stop Tail and Number Plate Lamp and Parts	14-15
Switches	9 and 11
GIRLING EQUIPMENT	18-19

For additional details apply to Lucas Agents

JOSEPH LUCAS (EXPORT) LIMITED . 46 PARK STREET, LONDON W.1

GLOSSARY OF TERMS

TECHNISCHE BENAMINGEN







- | | | |
|--|--|---------------------------------------|
| 1 Magneet | 57 Voering, geïsoleerd | 117 Dim |
| 2 Klemring voor stroomafnemer | 58 Plaat, borstelhouderbussen | 118 Hoorn drukknop |
| 3 Rubberkap voor stroomafnemer | 59 Verenstel | 119 Stoplicht |
| 4 Stroomafnemer rechts | 60 Lagerschild aandrijfzijde | 120 Veer |
| 5 Stroomafnemer links | 61 Lagerbus | 121 Amperemeter |
| 6 Borstel met veer | 62 Anker | 122 Vertikaal dimlicht |
| 7 Kabelmoer voor hoogspanningskabel | 63 Veldspoelen | 123 Dimlicht naar links |
| 8 Deksel contactbreker | 64 Veldklem | 124 Europa (niet Frankrijk) |
| 9 Contactbreker | 65 Reparatie set | 125 Frankrijk |
| 10 Contactset | 66 Schakelaar of elektromagnetische schakelaar | 126 Rand |
| 11 Contactveren | 67 Magdyno | 127 Montageveertjes |
| 12 Massa-borstel | 68 Dynamo | 128 Schroef montagerand |
| 13 Vervroegingsmechanisme | 69 Magneet | 129 Rubberrand |
| 14 Rubberkap voor vervroeging | 70 Klemband | 130 Vertikaal dimlicht |
| 15 Nokschijf | 71 Stroomafnemer | 131 Dimlicht naar rechts |
| 16 Pen met drukveer voor K.B. deksel | 72 Kabelmoer | 132 Europa (niet Frankrijk) |
| 17 Schild en huis voor nokkenring | 73 Deksel, onderbreker | 133 Frankrijk |
| 18 Magneet | 74 Onderbreker | 134 Hoofdlicht |
| 19 Isolatiecup | 75 Contacten | 135 Stadslicht |
| 20 Asmoer | 76 Borgveer voor nok | 136 Binnenwerk fittingen |
| 21 Anker | 77 Nokschijf | 137 Lamphouder (alleen Frankrijk) |
| 22 Sleepring | 78 Vervroegingsmechanisme | 138 Steker of stopkontakt |
| 23 Condensator | 79 Pen met veer | 139 Bout lampmontage |
| 24 Kogellager k.b. zijde | 80 Lagerschild k.b. zijde | 140 Kabelnippel |
| 25 Kogellager a.d. zijde | 81 Isolatie cup k.b. & a.d. zijde | 141 Lamp |
| 26 Massaborstel met houder | 82 Kogellager k.b. & a.d. zijde | 142 Glas stopachterlicht |
| 27 Massaborstel | 83 Deksel a.d. zijde | 143 Glas nummerplaatverlichting |
| 28 Pen met drukveer voor stroomafnemer | 84 Tandwiel set | 144 Moer of bout glasmontage |
| 29 Oliekeerring | 85 Anker | 145 Rubber stofrand |
| 30 Isolatie cup | 86 Sleepring | 146 Grondplaat |
| 31 Huis pakking | 87 Borstelhouder compleet | 147 Rubber kap |
| 32 Reparatie set | 88 Borstel met veer | 148 Lampkontakten voor fitting |
| 33 Centrifugaal vervroeging | 89 Verdeler | 149 Huis van lamphouder |
| 34 Vervroegingsveertjes | 90 Klemplaat | 150 Rubber kabelkap |
| 35 Dynamo | 91 Kap | 151 Moer lampmontage |
| 36 Borstels | 92 Borstel met veer | 152 Reflektor |
| 37 Lagerschild | 93 Rubber kapje | 153 Batterij |
| 38 Kogellager borstelzijde | 94 Kabeleinde kontakt | 154 Lamp |
| 39 Isolatieplaat met borstelhouders | 95 Rotor | 155 Moer of bout glasmontage |
| 40 Borstelveren | 96 Aansluitbout | 156 Glas |
| 41 Deksel borstelzijde | 97 Aansluitblokje | 157 Vertikaal dimlicht |
| 42 Kogellager a.d. zijde | 98 Condensator | 158 Dimlicht naar links |
| 43 Lagerschild a.d. zijde | 99 Kontakt set | 159 Export Europa (behalve Frankrijk) |
| 44 Oliekeerring | 100 Grondplaat | 160 Parkeerlicht |
| 45 Asmoer en borgschroef | 101 Nok | 161 Stop- achter en nummerplaatlicht |
| 46 Aandrijftandwiel | 102 Vervroegingsveertjes | 162 Stadslicht |
| 47 Anker | 103 Vervroegingsgewichten | 163 Amperemeter of waarschuwingslicht |
| 48 Veldspoelen | 104 Verdeleras | 164 Wisselstroomdynamo compleet |
| 49 Trekbout | 105 Kap klembeugel | 165 Rotor |
| 50 Reparatie set | 106 Lagerbus of kogellager | 166 Stator |
| 51 Startmotor | 107 Bobine | 167 Kabelklem |
| 52 Bout | 108 Regelaar | 168 Gelijkrichter |
| 53 Koolborstel | 109 Kap | 169 Veerelement |
| 54 Lagerschild borstelzijde | 110 Hoorn | 170 Rubber bus met metalen lagerbur |
| 55 Lagerbus | 111 Steun | 171 Veer |
| 56 Stuitkussen | 112 Paneel | 172 Stofkap |
| | 113 Lichten | |
| | 114 Knop (light) | |
| | 115 Ontsteking of kortsluitschakelaar | |
| | 116 Knop (ontsteking) | |

MAGNETO AND PARTS

1 2 3 4 5 6

1963

SPECIFICATIONS

MAKE AND MODEL	MAGNETO	CLIP ASSEMBLY, PICK-UP	RUBBER COVER, PICK-UP	PICK-UP ASSEMBLY		BRUSH AND SPRING PICK-UP
				RIGHT HAND	LEFT HAND	
						
(1) A.M.C. (A.J.S. and MATCHLESS) Twin cyl. Competition Models (31 'Swift' and G12 'Majestic', optional)	42264D	455734	458658	458367	458368	451260
(2) Single cyl. Competition Models	42347E	455733	457810		456794	451260
(3) Single cyl. Models (America)	42371B	455733	457810		456794	451260
B.S.A.						
(4) A10 'Golden Flash'	42379D			458865	458866	451260
(5) A10 'Super Rocket' and 'Rocket Gold Star'	42413A			459190	459190	451260
(6) B34 and M21	46048A	See Magdyno				
(7) B34 'Gold Star' Competition Models	42348E	455733	457810		456794	451260
(8) B34 Racing Models	42123M	455733	457810		456794	451260
ENFIELD						
(9) 736 c.c. 'Interceptor'	42369B		458658	458367	458368	451260
INDIAN (America only)						
(10) 'Apache'	42264B/D	455734	458658	458367	458368	451260
(11) 'Westerner' and 'Woodsmen'	42347D/E	455733	457810		456794	451260
MATCHLESS (See A.M.C.)						
NORTON						
(12) 'Dominator' 885S and 650SS, 'Manxman' and 'Atlas'	42368D	455734	458658	458876	458876	451260
PANTHER						
(13) 100 and 120	46047B	See Magdyno				
TRIUMPH						
(14) TR6SS and T120 (U.S.A. only)	42368D	455734	458658	458876	458876	451260

MAGNETO AND PARTS *continued*











18 19 20 21 22 23

1963











SPECIFICATIONS

MAKE AND MODEL	MAGNETO	CUP, INSULATING, BEARING	NUT, SHAFT	ARMATURE	SLIP RING	CONDENSER
(1) A.M.C. (A.J.S. and MATCHLESS) Twin cyl. Competition Models (31 'Swift' and G12 'Majestic', optional)	42264D	451379	170109	459004	455361	458339
(2) Single cyl. Competition Models	42347E	463932	170109	493176	464277	454415
(3) Single cyl. Models (America)	42371B	463932	170109	493176	464277	454415
B.S.A.						
(4) A10 'Golden Flash'	42379D	451379		459004	455361	458339
(5) A10 'Super Rocket' and 'Rocket Gold Star'	42413A	451379		459004	455361	458339
(6) B34 and M21	46048A	See Magdyno				
(7) B34 'Gold Star' Competition Models	42348E	463932	170109	493176	464277	454415
(8) B34 Racing Models	42123M		170109			
ENFIELD						
(9) 736 c.c. 'Interceptor'	42369B	451379	170109	459142	454497	458339
INDIAN (America only)						
(10) 'Apache'	42264B/D	451379	170109	459004	455361	458339
(11) 'Westerner' and 'Woodsmen'	42347D/E	463932	170109	493176	464277	454415
MATCHLESS (See A.M.C.)						
NORTON						
(12) 'Dominator' 885S and 650SS, 'Manxman' and 'Atlas'	42368D	463932	170109	459376	456727	
PANTHER						
(13) 100 and 120	46047B	See Magdyno				
TRIUMPH						
(14) TR6SS and T120 (U.S.A. only)	42368D	463932	170109	459376	456727	

MAGNETO AND PARTS







	7	8	9	10	11	12	13	14	15	16	17
	NUT, H.T. CABLE	COVER, CONTACT BREAKER	CONTACT BREAKER	CONTACT SET	SPRINGS, ACTUATING	BRUSH AND SPRING, C.B. EARTHING	CONTROL PARTS, SET	RUBBER COVER, CONTROLSET	CAM	SPRING AND PIN, C.B. COVER	PLATE, HOUSING, C.B. END
											
(1)	410600	458619	492854	54440888			463107	454475	458725	458613	458726
(2)	410600	459199	492854	54440888			459305	454475	459321		459313
(3)	410600	459205	492854	54440888			459305	454475	459321		459313
(4)	410600	459269	492854	54440888					459130		54440096
(5)	410600	459269	492854	54440888			463107	454475	458725		54440090
(6)											
(7)	410600	459199	492854	54440888			459305	454475	459321		459313
(8)	455791	459199	470924			470537	457117	454475			
(9)	410600	458619	493836	54440887			463107	454475	458855	458613	493747
(10)	410600	458619	492854	54440888			463107	454475	458725	458613	458726
(11)	410600	459199	492854	54440888			459305	454475	459321		459313
(12)	410600	459205	492854	54440888		455190			459130		493716
(13)											
(14)	410600	459205	492854	54440888		455190			459130		493716

MAGNETO AND PARTS *continued*

	24	25	26	27	28	29	30	31	32	33	34
	BEARING, C.B. END	BEARING, DRIVE END	BRUSH, SPRING AND HOLDER, EARTHING	BRUSH AND SPRING, EARTHING	SPRING AND PIN, PICK-UP	OIL SEAL	CUP, INSUL., D.E. BEARING	BODY GASKET	SUNDRY PARTS SET	AUTO-ADVANCE UNIT	SPRINGS SET A.-A. UNIT
											
(1)	189291	189244	455191	455190	458370	459002	459005		458675		
(2)	189294	189294	455191	455190		459033	463932		454697		
(3)	189294	189294	455191	455190		459033	463932		454697		
(4)	189291	189244	455191	455190	458370	459002	459005		458675	47503E	498157/S
(5)	189291	189244	455191	455190	458370	459002	459005		458675		
(6)											
(7)	189294	189294	455191	455190		459033	463932		454697		
(8)			455191	455190					458869		
(9)	189291	189244	455191	455190	458370	459002	459005		458675		
(10)	189291	189244	455191	455190	458370	459002	459005		458675		
(11)	189294	189294	455191	455190		459033	463932		454697		
(12)	189294	189244	455191	455190		459002	459005		458675	47508D	498157/S
(13)											
(14)	189294	189244	455191	455190		459002	459005		458675	47502B	498157/S







GENERATOR AND PARTS

1963 SPECIFICATIONS

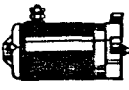
		35	36	37	38	39	40
MAKE AND MODEL		GENERATOR	BRUSH SET	BRACKET, C.E.	BEARING, C.E.	INSUL. PLATE WITH BRUSHGEAR	BRUSH SPRING
(1)	A.M.C. (A.J.S. and MATCHLESS) G3C 'Maestro' and 16C 'Experts'	 20038B	 200737	 200713/S	 189210	 200911	 220197
(2)	B.S.A. M21 and B34 'Gold Star'	20034B	200737	200713/S	189210	200911	220197
(3)	A10 and 650 c.c. Twin 'Rocket Gold Star'	20036A	200737	200713/S	189210	200911	220197
MATCHLESS (See A.M.C.)							
(4)	PANTHER 100 and 120	20034A	200737	200713/S	189210	200911	220197









STARTER AND PARTS

1963 SPECIFICATIONS











		51	52	53	54	55	56
MAKE AND MODEL		STARTER	BOLT	BRUSH SET	C.E. BRACKET	BEARING BUSH	THRUST PAD
(1)	NORTON 397 c.c. 'Electra'	 26509A	 54254142	 54252361	 54254127	 261233	 54252180

MAGDYNO AND PARTS



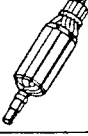





1963 SPECIFICATIONS

		67	68	69	70	71	72	73	74	75
MAKE AND MODEL		MAGDYNO	GENERATOR	MAGNETO PORTION	STRAP ASSEMBLY	PICK-UP	NUT, MOULDED	COVER, CONTACT BREAKER	CONTACT BREAKER	CONTACT SET
(1)	B.S.A. M21 and B34 'Gold Star'	 46048A	 20034A	 464247	 460056	 463066	 410600	 460061	 460051	 484098
(2)	PANTHER 100 and 120... ..	46047B	20034A	464243	460056	463066	410600	460061	460051	484098

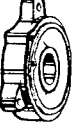

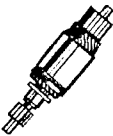
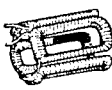









GENERATOR AND PARTS

	41	42	43	44	45	46	47	48	49	50
	C.E. COVER	BEARING, D.E.	BRACKET, D.E.	OIL SEAL	SHAFT NUT SCREW, GEAR RETAINING	GEAR, DRIVING	ARMATURE	FIELD COIL	THROUGH BOLT	SUNDRY PARTS SET
										
(1)	200924	189307	200805				200802	200188	200227	200806
(2)	200923	189307	200912		111704	454495	200754	200731	200732	200806
(3)	200924	189307	200382	*200378	111704		200752	200731	200732	200806
(4)	200923	189307	200912		111704	454495	200754	200731	200732	200806
				*Oil thrower						

STARTER AND PARTS

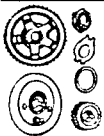
	57	58	59	60	61	62	63	64	65	66
	LINER INSUL.	PLATE, BRUSH BOXES	SPRING SET	BRACKET, D.E.	BEARING BUSH	ARMATURE	FIELD COIL	FIELD TERMINAL	SUNDRY PARTS, SET	SWITCH OR SOLENOID
										
(1)	54251728	54251740	54252360	54255890	54255274	54255281	54251462	54251387	54252417	76464E

MAGDYNO AND PARTS









	76	77	78	79	80	81	82	83	84	85	86	87	88
	JUMP RING	CAM	CONTROL PARTS SET	SPRING PIN	END PLATE, C.B.	CUP, INSUL., C.E. & D.E.	BEARING, C.B. & D.E.	END PLATE, D.E.	GEAR SET	ARMA-TURE	SLIP RING	BRUSH, SPRING & HOLDER	BRUSH & SPRING
													
(1)	455347	493181	463107	463899	464255	*451379 †463932	*189291 †189294	463989	462863	464205	454496	455191	455190
(2)	455347	493181	463107	463899	464255	*451379 †463932	*189291 †189294	463989	462863	464205	454496	455191	455190
						*Contact breaker end †Drive end	*Contact breaker end †Drive end						

DISTRIBUTOR AND PARTS











89 90 91 92 93 94 95 96

1963

SPECIFICATIONS

	89	90	91	92	93	94	95	96
MAKE AND MODEL	DISTRIBUTOR 	CLAMPING PLATE 	COVER 	BRUSH & SPRING 	GROMMET, RUBBER 	CLIP, CABLE CONTACT 	ROTOR ARM 	TERMINAL 
(1) A.M.C. (A.J.S. and MATCHLESS) A.J.S. 16 and 18; Matchless G3 and G80 ...	†47595A ‡47579H							
(2) A.J.S. 31; Matchless G12 ...	40589D	420151	425049	404435	421554	421863	423486	123154
(3) ARIEL 'Arrow' and 'Leader' ...	*425739							
(4) B.S.A. B2 'Sunbeam' Scooter (6 volt) ...	*47583B							
(5) B2S 'Sunbeam' Scooter (12 volt) ...	*47583B							
(6) C15 and SS80 250 c.c., B40 and B40SS90 ...	40867A		54411737					405314
(7) C15T and C15S Competition ...	40868A		54411737					405314
(8) A50 and A65 ...								
(9) ENFIELD 250 c.c. and 350 c.c. ...	*47571E							
(10) 500 c.c. and 700 c.c. ...								
(11) 500 c.c. 'Sports Twin' and 'Constellation' (12 volt) ...	40610A	420151	425049	404435	421554	421863	423486	123154
(12) INDIAN (America only) 'Trailblazer' ...	40589D	420151	425049	404435	421554	421863	423486	123154
(13) NORTON 348 c.c. 50 and 490 c.c. ES2 ...	40628B	420151	424151					123154
(14) 500 c.c. and 650 c.c. 'Dominator' ...	40589D	420151	425049	404435	421554	421863	423486	123154
(15) TRIUMPH T51 and TW2 'Tigress' (6 volt) ...	*47583B							
(16) TW2S 'Tigress' (12 volt) ...	*47583B							
(17) T20 and T20SH 'Tiger Cub' ...	*47604B							
(18) T20SR and T20SC 'Sports' ...	*47603B							
(19) 3TA 'Twenty-one' ...	40573H		425049	404435	421554	421863	423486	123154
(20) 3TA (later) ...	40907A		425049	404435	421554	421863	423486	123154
(21) 5TA 'Speed Twin' ...	40646B		425049	404435	421554	421863	423486	123154
(22) T90 and T100SS ...	*47606B							
(23) TR6SS, T120 and GT ...	*47605B							
(24) T100SC ...	*47602B							
	*Contact breaker †Contact breaker (350 c.c.) ‡Contact breaker (500 c.c.)							

DISTRIBUTOR AND PARTS





	97	98	99	100	101	102	103	104	105	106	Ignition Coil 107
	BUSH, TERMINAL INSUL.	CON- DENSER	CONTACT SET	BASE, CONTACT BREAKER	CAM	A.A. SPRINGS	A.A. WEIGHTS	SHAFT & ACTION PLATE	CLIP, COVER	BUSH OR BEARING	IGNITION COIL
											
(1)		54413002	420196	465958	465939	425298/S 416136/S	415729	54414514 425733			45077E *45152B
(2)	423110	54410823	425219	423113	425284	54412732	421056/S	425444	424158	425498	45077E *45152B
(3)		425377	54410078	425370							45152B
(4)		425377	54410078	425370	54440029	54413020	54440031	54440032			45077E
(5)		425377	54410078	425370	54440029	54413020	54440031	54440032			45101A
(6)	421109	421327	421106		421206	54412018	421056	421054			45077E *45152A
(7)	421109	421327	421106		54415051	54412018	421056	421054			45112A/D *45149B
(8)											45077E *45152A
(9)		54413002	420196	465958	465939	421457/S	415730	469107			45077E *45152B
(10)											45077E *45152B
(11)	423110	54410823	425219	423113	425598	54412732	421056/S	425596	424158	432121	45077E *45152B †45110A/D
(12)	423110	54410823	425219	423113	425284	54412732	421056/S	425444	424158	425498	45077E
(13)	423110	54410823	425219	423113	425746	425398/S	421056/S	54410545	424158	423121	45077E *45152B
(14)	423110	54410823	425219	423113	425284	54412732	421056/S	425444	424158	425498	45077E *45152B
(15)		425377	54410078	425370	54440029	54413020	54440031	54440032			45077E
(16)		425377	54410078	425370	54440029	54413020	54440031	54440032			45101A
(17)		425377	54415803	425370	54440029	425768	54440031	54415655			45152A
(18)		425377	54415803	425370	54415053	54415640	54440031	54415749			45112D *45149B
(19)	423110	54410823	425219	423113	424972	425398/S	421056/S	424967	424158	423571	45152A
(20)	423110	54410823	425219		54415621	425398	421056	424697	424158	423571	
(21)	423110	54410823	425219	423113	424972	54410895	421056/S	424967	424158	423571	45152A
(22)		425377	54415803	425370	54441729	54412550	425379	54415753			45152A
(23)		425377	54415803	425370	54441729	54415642	425379	54415751			45152A
(24)		425377	54415803	425370	54415473	54415644	425359	54415747			45112D *45149B

*Later
†'Constel-
lation'
(12 volt)

1963 SPECIFICATIONS











Control Box and Parts

HORN

		108	109	110	111		
MAKE AND MODEL		CONTROL BOX	MODEL	COVER	HORN	MODEL	BRACKET
							
(1)	A.M.C. (A.J.S. and MATCHLESS) A.J.S. 16 and 18; Matchless G3 and G80				70163A	8H	54680850
(2)	A.J.S. 16C; Matchless G3C	37232K	RB108	54381655	70163A	8H	54680850
(3)	A.J.S. 18CS; Matchless G80CS				70163A	8H	54680850
(4)	A.J.S. 31CSR; Matchless G12CSR				70163A	8H	54680850
(5)	A.J.S. 31; Matchless G12				70163A	8H	54680850
ARIEL							
(6)	'Arrow' and 'Super Sports'				70178A	8H	54680850
(7)	'Leader'				70178A	8H	54680850
B.S.A.							
(8)	175 c.c. B1 ('Sunbeam' Scooter)				70166A	8H	
(9)	250 c.c. B2 ('Sunbeam' Scooter, 6 volt)				70166A	8H	
(10)	250 c.c. B2S ('Sunbeam' Scooter, 12 volt)				70177A	8H	
(11)	C15 'Star', SS80 'Star', B40 'Star' and B40 SS90				70169A	8H	54680850
(12)	C15T and C15S Competition				70145D	HF1950	
(13)	M21	37225K	RB108	54381654	70169A	8H	54680850
(14)	B34 'Gold Star' and Competition	37221K	RB108	54381655	70169A	8H	54680850
(15)	A10 'Golden Flash'	37221K	RB108	54381655	70169A	8H	54680850
(16)	A10 'Super Rocket'	37221K	RB108	54381655	70169A *069482	8H HF1234	54680850
(17)	650 c.c. Twin 'Rocket Gold Star'	37221K	RB108	54381655	069482A	HF1234	
(18)	A50 and A65 'Star' Twin				70169A	8H	54680850
ENFIELD							
(19)	250 c.c. 'Clipper', 'Crusader Sports', 'Super Sports 5', 'Trials' and 'Continental'				70163A	8H	54680850
(20)	350 c.c. 'Bullet'				70163A	8H	54680850
(21)	500 c.c. 'Sports Twin'				70163A	8H	54680850
(22)	700 c.c. 'Constellation' and 736 c.c. 'Interceptor'				069424	HF1234	
(23)	700 c.c. 'Constellation'						
(24)	736 c.c. 'Interceptor'						
(25)	'Constellation' (12 volt)				54068075	9H	54680686
INDIAN (America only)							
(26)	'Apache'				70163A	8H	54680850
(27)	'Trailblazer'				70163A	8H	54680850
(28)	'Westerner' and 'Woodsman'				70163A	8H	54680850
NORTON							
(29)	250 c.c. 'Jubilee' and 350 c.c. 'Navigator'				70163A	8H	54680850
(30)	348 c.c. Model 50, 490 c.c. Model ES2, 497 c.c. Model 88, and 650 c.c. 'Dominator'				70163A	8H	54680850
(31)	497 c.c. 88SS, 650 c.c. SS 'Dominator', 650 c.c. 'Manxman' (U.S.A.) and 750 c.c. 'Atlas' (U.S.A.)				70163A	8H	54680850
(32)	397 c.c. 'Electra'				70164B	8H	54680850
PANTHER							
(33)	'Princess' Scooter (6 volt)						
(34)	249 c.c. 35 and 45 Sports						
(35)	600 c.c. 100 and 650 c.c. 120	37225J	RB108	54381654	069498	HF1234	700168
					*U.S.A.		

SWITCHES

Ammeter





	112	113	114	115	116	117	118	119	120	121
	PANEL	LIGHTING	KNOB (LIGHTING)	CUTOUT OR IGNITION	KNOB (IGNITION)	DIPPER	HORN PUSH	STOP LAMP	SPRING	AMMETER
										
(1)		34289A	54330934	34287B	54332498		*31563D	31383A/B		36084F *36296A
(2)		31754A					*31563D	31384B	315543	36084F *36296A
(3)		31784D					*31563D	31384B	315543	36084F *36296A
(4)		34289A *31784D	54330934	76204D			*31563D	31384B	315543	36084F *36296A
(5)		34289A	54330934	34287B *76204D	54332498		*31563D	31383A/B		36084F *36296A
(6)	*31820A	34289A	54330934	34427A/B	*54336178	31549B	76234A	54033234		36084F
(7)	*31820A †31823A	34289A	54330662	34427A/B	*54336307	31549B	76234A	31384B 54033234		36084F
(8)										
(9)		54033027	54331351	54033028	54331482		*31563D	31437B		
(10)		54033027	54331351	54033028	54331482	*76463A	*31563D	31437B		
(11)		34289A	*54330485 54330934	34427A	*54336178			31827A		36084F
(12)		31356A		76204D		31620E	76204D			36084F
(13)		31763A		76204D				31281B	315723	36084F
(14)		31763A		76204D		31549B	76204D †76206E	31437B		36084F †36296A
(15)		31763A	*351803	76204D				34257A		36084F *†36296A
(16)		31763A		76204D			*31563D	34257A		36296A
(17)		31763A		76204D				31437B		36296A
(18)		34289A	*54330485 54330934	34427A	*54336178			34448B		36296A
(19)		†31784A/D 34289A	351815 54330934	†34093B 34427A	*54336178	31549B	†76204D *31563D	31688A/B		36084F †36296A
(20)		†31784A/D 34289A	351815 54330934	†34093B 34427A	*54336178	31549B	†76204D *31563D	31688A/B		36084F
(21)		31491A †31784A/D †34289A	351567 351815 54330934	34093B †34427A †34093B		31549B	†76204D	31688A/B		36084F
(22)		31491A †31784A/D †34289A	351567 351815 54330934	†34427A 54033056	*54336178 54331351	31549B	§76204D *31563D §31563D	31688A/B		36084F §36296A
(23)				†34093B						
(24)				*76204A						
(25)		34289A		34427A/B			*31563D			36084F
(26)		§34289A	54330934	76204D			*31563D	31384B	315543	36084F *36296A
(27)		34289A	54330934	34287A	54332498		*31563D	31383A/B		36084F *36296A
(28)		31784D					*31563D	31384B	315543	36084F *36296A
(29)										
(30)		‡34289A 31443E	†54330934 318346	‡34287A §34427B	54332498		*31563D	31383B		36084F *36296A
(31)		34289A	54330934	76204D			*31563D	31383B		36084F *36296A
(32)						*31872A				
(33)		31758D	351815					31437D	315738	36084F
(34)		31784D	351815				*31563D	31437D	315543	36084F
(35)		31754B	351815				*31563D	31437D	315738	36084F
	*Neutral gear indicator †Flasher switch	*Sports Tourer †'Airflow' ‡Later §Roadster Lighting and ignition	*Escutcheon plate †Later	*When fitted †'Airflow' ‡Later §Later (key type)	*Rubber cover	*Starting motor	*Horn push and dipper †'Clubman' ‡Sports only §'Interceptor' 'Interceptor' (U.S.A.)			*Later †Fitted to Headlamp 58859 and 58873 ‡'Continental' §'Interceptor' (U.S.A.)

continued

1963 SPECIFICATIONS









Control Box and Parts

HORN











MAKE AND MODEL	108		109		110		111	
	CONTROL BOX	MODEL	COVER	MODEL	HORN	MODEL	BRACKET	
								
TRIUMPH								
(1) 'Tigress' Scooter TSI					70166A	8H		
(2) 'Tigress' Scooter					70177A	8H		
(3) T20SR and T20SC					70145D	HF1950		
(4) T20					70178A	8H	54680850	
(5) T20 (later)					70169A	8H	54680850	
(6) T20SH					70163A	8H	54680850	
(7) 3TA and 5TA					70163A	8H	54680850	
(8) TR6SS, T120 and 6T					70163A	8H	54680850	
(9) T100SS and T90					70163A	8H	54680850	
(10) T100SC					70145D	HF1950		

HEADLAMP AND PARTS







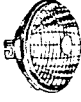

1963 SPECIFICATIONS

MAKE AND MODEL	HEADLAMPS				RIM OR DOOR	WIRE, LIGHT UNIT FIXING	SCREW, RIM FIXING	BEAD OR GROMMET
	VERTICAL DIP	DIP LEFT	EUROPE (NOT FRANCE)	FRANCE				
								
(1) A.M.C. (A.J.S. and MATCHLESS) A.J.S. 16 and 18; Matchless G3 and G80 ...	58702A/B		58832A/B	58833A/B	553248	504665	144921	
(2) A.J.S. 16C; Matchless G3C	58224D				553248	504665	144921	
(3) A.J.S. 16C; Matchless G3C (later)	58859A				553248	504665	144921	
(4) A.J.S. 18CS; Matchless G80CS	58829A/B				553248	504665	144921	*199002
(5) A.J.S. 31; Matchless G12	58702A/B		58832A/B	58833A/B	553248	504665	144921	
(6) A.J.S. 31; Matchless G12 (alternative, magneto ignition)	58704A/B		58830A/B	58831A/B	553248	504665	144921	
(7) A.J.S. 31CSR; Matchless G12CSR Roadster	58704A/B		58830A/B	58831A/B	553248	504665	144921	
(8) Alternative	58258B				554440		198898	
(9) Tourer	*58556A				553248	504665	144921	*199002
(10) Tourer (later)	*58878A				553248	504665	144921	199002
ARIEL								
(11) 'Arrow' and 'Super Sports Arrow'	58892B		58893B	58896B	534343	504665	144921	*199005
(12) 'Leader'	58897A		58898A	58899A	54520003	504665	555911	
B.S.A.								
(13) B2 ('Sunbeam' Scooter, 6 volt)	58417D		58418D	58419D	516723 *516910	500291 *516911	516710	
	*58420B				516723	500291	516710	
(14) B2S ('Sunbeam' Scooter, 12 volt)	58421D		58422D	58423D	516723 *516910	500291 *516911	516710	
	*58424B				516723	500291	516710	
(15) C15, SS80, B40 'Star' and B40SS90	58234D		58392A	58391A	534343	504665	144921	
(16) C15T and C15S	58395E				534343	504665	144921	*199003
(17) M21		58169A			553248	504665	144921	
(18) A10 'Golden Flash', A50 'Star' and A65 'Star'	58159B	58158B	58160B	58161B	553248	504665	144921	
	*58873A				553248	504665	144921	
	*U.S.A. only				*France	*France		*Grommet, cable entry

SWITCHES

	112	113	114	115	116	117	118	119	120	Ammeter 121
	PANEL	LIGHTING	KNOB (LIGHTING)	CUTOFF OR IGNITION	KNOB (IGNITION)	DIPPER	HORN PUSH	STOP LAMP	SPRING	AMMETER
										
(1)										
(2)	*76463A	54033028	54331482	54033027	54331351		*31563D	31437B	315738	
(3)		31356A		76204D		31620B	76204D	31437B	315738	
(4)		34289A	54330662	34427A	54336307	31549B	76234A	31437B	315738	
(5)										
(6)		34289A	54330662	34427A	54336307	31620B	76204D	31437B	315738	
(7)		*31443A	318346				*31563D	31383A		36189B
(8)		34289A	54330934	34427A	54336178		*31563D	31383A		36296A
(9)		34289A	54330934	34427A	54336178		*31563D	31383A		36296A
(10)		31356A		76204D		31620B	76204D	31383A		
	*12 volt starter	*Lighting and ignition					*Horn push and dipper			

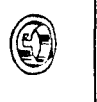
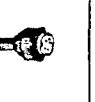
HEADLAMP AND PARTS







	130	131	132	133	134	135	136	137	138	139	140
	LIGHT UNITS				BULB HOLDERS OR ADAPTORS			BACKSHELL (FRANCE ONLY)	PLUG OR SOCKET	SCREW, LAMP FIXING	SLEEVE, TERMINAL
	VERTICAL DIP	DIP LEFT	EUROPE (NOT FRANCE)	FRANCE	MAIN	PILOT	INTERIOR, PILOT				
											
(1)	516798		555275	516802	554602 *562303	554710	553780	552943		112201	555910
(2)	516798				554602	554710	553780		*54941678	112201	555910
(3)	516798				554602	554710	553780		54941768	112201	555910
(4)	516798				554602	554710	553780		*54944387	112201	555910
(5)	516798		555275	516802	554602 *562303	554710	553780	552943		112201	555910
(6)	516798		555275	516802	554602 *562303	554710	553780	552943		112201	555910
(7)	516798		555275	516802	554602 *562303	554710	553780	552943		112201	555910
(8)	516798				554602	554710	553780				555910
(9)	516798				554602	554710	553780		*54944387	112201	555910
(10)	516798				554602	554710	553780		54944387	112201	555910
(11)	54520858		54521021	516912	554602 *562303	554710	553780	552943		112201	555910
(12)	516828		516829	516912	554602 *562303	554710	553780	553470			555910
(13)	516767		516658	516912	554946 *562303	554710	553780	553470			555910
(14)	516659 516767		516658	516912	554946 *562303	554710	553780	553470			555910 555910
(15)	516659 516828		516829	516912	554946 554602 *553470	554710	553780				555910 555910
(16)	54520452				554602					112201	555910
(17)		555309			554602	554710	553780			112201	555910
(18)	516810 516798	516812	516811	516802	554602 *562303 554602	554710	553780	552943			555910
					*France				*Plug and cable		

continued

HEADLAMP AND PARTS

1963

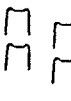
SPECIFICATIONS





MAKE AND MODEL		HEADLAMPS				RIM OR DOOR	WIRE, LIGHT UNIT FIXING	SCREW, RIM FIXING	BEAD OR GROMMET
		122	123	124	125				
		VERTICAL DIP	DIP LEFT	EUROPE (NOT FRANCE)	FRANCE				
									
(1)	B.S.A.—continued B34 'Gold Star' and Competition	58224D *58859A				553248 553248	504665 504665	144921 144921	
(2)	A10 'Super Rocket'	58873A				553248	504665	144921	
(3)	'Rocket Gold Star'	58873A				553248	504665	144921	
		ENFIELD							
(4)	All Models except 'Airflow' and 'Super Sports 5'	50943E		51112D	51134D	553248	504665	144921	
(5)	All Models with 'Airflow'	58258B				554440		198898	555415
(6)	'Super Sports 5'	58933A		51112D	51134D	553248	504665	144921	
(7)	'Continental'	58878A				553248	504665	144921	*199002
(8)	'Interceptor' (U.S.A.)	58937A				553248	504665	144921	*199002
(9)	'Constellation' (12 volt)	59118A				553248	504665	144921	
(10)	'Constellation' (12 volt, 'Airflow')	59119A				554440		198898	
		INDIAN (America only)							
(11)	'Trailblazer'	58702A/B				553248	504665	144921	
(12)	'Apache'	58556A				553248	504665	144921	*199002
(13)	'Westerner' and 'Woodsman'	58829A/B				553248	504665	144921	
		NORTON							
(14)	50 and ES2	58404A *58702A/B		58832A/B	58833A/B	553248	504665	144921	*862217 †517239
(15)	'Dominator' 88 and 650	*58702A/B	58124D	58832A/B	58833A/B	553248	504665	144921	*862217 †517239
(16)	'Dominator' 88SS and 650SS	58704A/B		58830A/B	58831A/B	553248	504665	144921	*862217 †517239
(17)	'Manxman' and 'Atlas'	58704A/B				553248	504665	144921	
		PANTHER							
(18)	'Princess' Scooter (6 volt)	58552A				534343	504665	144921	
(19)	35 and 45 Sports	58472A				534343	504665	144921	*862217 †199005
(20)	100 and 120	58092B				553248	504665	144921	*862217 †517239
		TRIUMPH							
(21)	'Tigress' (6 volt)	58417D		58418D	58419D	516723 *516910	500291 *516911	516710	
(22)	'Tigress' (12 volt)	†58420D 58421D		58422D	58423D	516723 *516910	500291 *516911	516710	
(23)	T20	†58424A/B 58975A		58976A	58977A	516723 *516910	500291 *516911	516710	
(24)	T20SR, T20SC and T100SC	†59004A 58395B				516723 534343	500291 504665	516710	*199003
(25)	3TA, 5TA and 6T	†51756E	51860B	51757D	51758B	553248	504665	144921	
(26)	TR6SS and T120	58934A				553248	504665	144921	
(27)	T100SS and T90	58934A				553248	504665	144921	
(28)	T20SH	58935A				534343	504665	144921	
		*Later †U.S.A. only				*France	*France		*Grommet, cable entry †Grommet, trip cable

HEADLAMP AND PARTS

		130	131	132	133	134	135	136	137	138	139	140
		LIGHT UNITS				BULB HOLDERS OR ADAPTORS			BACKSHELL (FRANCE ONLY)	PLUG OR SOCKET	SCREW, LAMP FIXING	SLEEVE, TERMINAL
		VERTICAL DIP	DIP LEFT	EUROPE (NOT FRANCE)	FRANCE	MAIN	PILOT	INTERIOR, PILOT				
(1)	516798					554602	554710	553780		*54941768	112201	555910
	516798					554602	554710	553780		*54941768	112201	555910
(2)	516798					554602	554710	553780		*54941699	112201	555910
(3)	516798					554602	554710	553780		*54941699	112201	555910
(4)	553925			553940	553948	554602				552943		555910
						*562303						
(5)	516798					554602	554710	553780				555910
(6)	516810			553940	553948	554602	554710	553780		552943		555910
						*562303						
						555319						
(7)	516798					554602	554710	553780		*54944387	112201	555910
(8)	516798					554602	554710	553780		*54944387	112201	555910
(9)	553921					554602						555910
(10)	555309					554602	554710	553780				555910
(11)	516798					554602	554710	553780			112201	555910
(12)	516798					554602	554710	553780		*54944387	112201	555910
(13)	516798					554602	554710	553780		*54944387	112201	555910
(14)	516798			555275	516802	554602	554710	553780		552943	112201	555910
						*562303						
(15)	516798	555309		555275	516802	554602	554710	553780		552943	112201	555910
						*562303						
(16)	516798			555275	516802	554602	554710	553780		552943	112201	555910
(17)	516798					554602	554710	553780			112201	555910
(18)	516828					554602	554710	553780				555910
(19)	516828					554602	554710	553780			112201	555910
(20)	516798					554602	554710	553780			112201	555910
(21)	516767			516658	516912	554946	554710	553780		553470		555910
						*562303						
	516659					554946						555910
(22)	516767			516658	516912	554946	554710	553780		553470		555910
						*562303						
	516659					554946						555910
(23)	516828			516829	516912	554602	554710	553780		553470		555910
						*562303						
	54520452					554602						555910
(24)	54520452					554602					112201	555910
(25)	516810	516812		516811	516802	554602	554710	553780		552943		555910
						*562303						
(26)	516798					554602	554710	553780			112201	555910
(27)	516798					554602	554710	553780			112201	555910
(28)	516828					554602	554710	553780			112201	555910
						*France †Europe (Not France)				*Plug and cable		









STOP TAIL AND NUMBER PLATE LAMP

1963 SPECIFICATIONS

MAKE AND MODEL		141	142	143	144
		LAMP 	LENS 	WINDOW 	NUT OR SCREW, LENS OR RIM FIXING 
A.M.C. (A.J.S. and MATCHLESS)					
(1)	A.J.S. 16, 18 and 31; Matchless G3, G80 and G12	53432B	573839	575200	575219
(2)	A.J.S. 18CS; Matchless G80CS	53432B	573839	575200	575219
(3)	A.J.S. 16C and 31CSR; Matchless G3C and G12CSR... ..	53432B	573839	575200	575219
ARIEL					
(4)	All Models... ..	53394B	573839	575200	575219
B.S.A.					
(5)	B1 ('Sunbeam' Scooter)				
(6)	B2 ('Sunbeam' Scooter, 6 volt)	53432B	573839	575200	575219
(7)	B2S ('Sunbeam' Scooter, 12 volt)	53454B	573839	575200	575219
(8)	'Bantam' and 'Bantam Major'				
(9)	C15 and SS80	53394B	573839	575200	575219
(10)	C15S and C15T	53825A	573839	575200	575219
(11)	B40, A10, A50 and A65 Models, 'Rocket Gold Star' and B40SS90	53432B	573839	575200	575219
(12)	M21 and B34 Models	53432B	573839	575200	575219
ENFIELD					
(13)	250 c.c. Models and 350 c.c. 'Bullet'	53394B	573839	575200	575219
(14)	700 c.c. and 736 c.c.	53432B	573839	575200	575219
(15)	500 c.c.	53432B	573839	575200	575219
(16)	'Constellation' (12 volt)	53454B	573839	575200	575219
INDIAN (America only)					
(17)	'Trailblazer'	53432B	573839	575200	575219
(18)	'Westerner' and 'Woodsmen'	53432B	573839	575200	575219
(19)	'Apache'	53432B	573839	575200	575219
NORTON					
(20)	All Models... ..	53432B	573839	575200	575219
(21)	397 c.c. 'Electra'	53973A/B	54572932		572289
PANTHER					
(22)	'Princess' Scooter (6 volt)	53394B	573839	575200	575219
(23)	35 and 45 Sports	53432B	573839	575200	575219
(24)	100 and 120	53432B	573839	575200	575219
TRIUMPH					
(25)	'Tigress' TS1 Scooter				
(26)	'Tigress' TW2 Scooter	53432B	573839	575200	575219
(27)	'Tigress' TW2S Scooter (12 volt)	53454B	573839	575200	575219
(28)	T20 and T20SH	53394B	573839	575200	575219
(29)	T20SR and T20SC	53432B	573839	575200	575219
(30)	3TA and 5TA	53432B	573839	575200	575219
(31)	6T, T100SS and T90	53432B	573839	575200	575219
(32)	TR6SS and T120	53432B	573839	575200	575219
(33)	T100SC	53432B	573839	575200	575219

STOP TAIL AND NUMBER PLATE LAMP

Battery

	145	146	147	148	149	150	151	152	153
	GASKET, LENS SEATING	BASE	GROMMET, BULB HOLDER	BULB HOLDER OR INTERIOR	SHELL, BULB HOLDER	CABLE GROMMET	NUT, LAMP FIXING	REFLEX REFLECTOR	BATTERY
									
(1)	575208	576002	575207	*573828	575209	573825	166014		PUZ7E-II
(2)	575208	576002	575207	573828	575209	573825	166014		MLZ9E
(3)	575208	576002	575207	573828	575209	573825	166014		PUZ7E-II
(4)	575208	576002	575207	*573828	575209	573825	166014		MLZ9E
(5)									MLZ9E
(6)	575208	576002	575207	*573828	575209	573825	166014		MLZ9E
(7)	575208	576002	575207	*573828	575209	573825	166014		*MLZ9E
(8)									PUZ5E-II
(9)	575208	576002	575207	*573828	575209	573825	166014		MLZ9E
(10)	575208	54571053	575207	*573832	54571021	573825	166014		MLZ9E
(11)	575208	576002	575207	*573828	575209	573825	166014		MLZ9E
(12)	575208	576002	575207	*573828	575209	573825	166014		PUZ7E-10
(13)	575208	576002	575207	*573828	575209	573825	166014		MLZ9E
(14)	575208	576002	575207	*573828	575209	573825	166014		MLZ9E
(15)	575208	576002	575207	*573828	575209	573825	166014		†PUZ7E-II
(16)	575208	575964	575207	*573828	575209	573825	166014		PUZ7E-II
(17)	575208	576002	575207	*573828	575209	573825	166014		MLZ9E
(18)	575208	576002	575207	*573828	575209	573825	166014		PUZ7E-II
(19)	575208	576002	575207	*573828	575209	573825	166014		MLZ9E
(20)	575208	576002	575207	*573828	575209	573825	166014		PUZ7E-II
(21)	54571677	54571319		*573828 54574348					MSLZ11E
(22)	575208	576002	575207	*573828	575209	573825	166014		MLZ9E
(23)	575208	576002	575207	*573828	575209	573825	166014		PUZ5E-II
(24)	575208	576002	575207	*573828	575209	573825	166014		PUZ7E-10
(25)									MLZ9E
(26)	575208	576002	575207	*573828	575209	573825	166014		MLZ9E
(27)	575208	575964	575207	*573828	575209	573825	166014		MLZ9E
(28)	575208	576002	575207	*573828	575209	573825	166014		PUZ5E-II
(29)	575208	576002	575207	*573828	575209	573825	166014		PUZ5E-II
(30)	575208	576002	575207	*573828	575209	573825	166014		PUZ7E-II
(31)	575208	576002	575207	*573828	575209	573825	166014		MLZ9E
(32)	575208	576002	575207	*573828	575209	573825	166014		MLZ9E
(33)	575208	576002	575207	*573828	575209	573825	166014		MLZ9E
				*Interior only					*2 off †'Interceptor' (U.S.A.)

SIDE LAMP AND PARTS







1963 SPECIFICATIONS

		154	155	156
MAKE AND MODEL		LAMP	NUT OR SCREW, LENS OR RIM FIXING	LENS
(1)	ARIEL 'Leader'	*53733D	526567	535901
(2)	ENFIELD All models	†52234A		573615
(3)	'Constellation', 12 volt (except 'Arrow')	52414A		573615
		*Flasher †Pilot		

continued

BULBS



1963 SPECIFICATIONS

		157	158	159	160	161	162	163
MAKE AND MODEL		MAIN BEAM			PILOT	STOP TAIL AND NUMBER PLATE	SIDE LAMP	AMMETER OR WARNING LIGHT
		VERTICAL DIP	DIP LEFT	EXPORT EUROPE (except France)				
(1)	A.M.C. (A.J.S. and MATCHLESS) All Models							
		312		403	988	384		
(2)	ARIEL 'Arrow' and 'Leader'	312		377	988	352	*317	990
(3)	B.S.A. B2 ('Sunbeam' Scooter 6 volt)	312		377	988	384		990
(4)	B2 ('Sunbeam' Scooter 12 volt)	425		350	989	380		987
(5)	C15, SS80 and B40 'Star' and B40	312		377	988	352 *384		
(6)	C15T and C15S	166				205		
(7)	M21		373		988	384		
(8)	B34, A10, A50, A65 and 'Rocket' 'Star'	312	373	403	988	384		
(9)	ENFIELD 250 c.c. Models and 350 c.c. 'Bullet'	312		403	988	352	†988	
(10)	Other Models	312		403	988	384	†988	
(11)	'Constellation' (12 volt)	414			989	380	989	
						*B40 only	*Flasher ('Leader') †Pilot	

continued







SIDE LAMP AND PARTS

1963 SPECIFICATIONS

		154	155	156
		LAMP	NUT OR SCREW, LENS OR RIM FIXING	LENS
				
(1)	PANTHER 120	*52268E	*145231	*526522 †54570739
		*Sidecar	*Cover fixing	*Lens (clear) †Lens (red)

BULBS





1963 SPECIFICATIONS

		157	158	159	160	161	162	163
		MAIN BEAM			PILOT	STOP TAIL AND NUMBER PLATE	SIDE LAMP	AMMETER OR WARNING LIGHT
		VERTICAL DIP	DIP LEFT	EXPORT EUROPE (except France)				
								
(1)	INDIAN All Models	312			988	384		
(2)	NORTON All Models	312	373	403	988	*380 384		
(3)	PANTHER 'Princess' Scooter (6 volt)	312			988	384		
(4)	35 and 45 Sports, 100 and 120	312			988	384	*951	
(5)	TRIUMPH TW2 and TS1 'Tigress' (6 volt)	312		377	988	384		998
(6)	TW25 'Tigress' (12 volt)	425		350	989	380		987
(7)	T20	312		377	988	352		
(8)	T20SR and T20SC	166				384		
(9)	3TA, 5TA and 6T	312	373	403	988	384		
(10)	TR6, T100SS, T120 and T90	312			988	384		
(11)	T100SC	166				384		
(12)	T20SH	166			988	352		
						**'Electra' only	*120 only	

ALTERNATOR AND PARTS

164 165 166 167 168

1963 SPECIFICATIONS

MAKE AND MODEL		*ALTERNATOR 	ROTOR 	STATOR 	CABLE CLIP 	RECTIFIER 
(1)	A.M.C. (A.J.S. and MATCHLESS) A.J.S. 16, 18 and 31; Matchless G3, G80 and G12	047534	423506	47122A	54211509	49072A
(2)	Ditto (later)	54021023	54213901	47164A	54210167	
(3)	A.J.S. 18CS and 31CSR; Matchless G80CS and G12CSR	54021018	423506	47154A	54211509	49072A
(4)	Ditto (later)	54021027	54213901	47162A	54210167	
(5)	ARIEL All Models	54021025	54213903	47161	54210167	49072A
(6)	B.S.A. B2 ('Sunbeam' Scooter, 6 volt)	047540	54210940	47136B		47132B
(7)	B25 ('Sunbeam' Scooter, 12 volt)	54021000	54210946	47135A		47128A
(8)	C15 'Star' and 5580	54021025	54213903	47161	54210167	49072A
(9)	C155 and C15T	54021039	54213901	47173	54210167	
(10)	B40 'Star' and B40SS90	54021023	54213901	47164A	54210167	49072A
(11)	A50 and A65 'Star'	54021023	54213901	47164A	54210167	49072A
(12)	ENFIELD 250 c.c. and 350 c.c.	54021025	54213903	47161A	54213907	49072A
(13)	Other Models	047531	423506	469427	54211509	49072A
(14)	Other Models (later)	54021023	54213901	47164A	54210167	49072A
(15)	INDIAN 'Apache', 'Westerner' and 'Woodsmen'	54021018	423506	47154	54211509	47132
(16)	'Trailblazer'	047534	423506	47122	54211509	47132
(17)	NORTON 50, ES2, 88 and 650	54021044	54213901	47181A	54210167	49072A
(18)	88 and 650 (later)	54021023	54213901	47164A	54210167	
(19)	88SS and 650SS	54021027	54213901	47162A		49072A
(20)	'Atlas' and 'Manxman'	54021046	54213901	47183A	54210167	49072A
(21)	TRIUMPH TW2 ('Tigress' Scooter 6 volt)	047540B	54210940	47136		47132B
(22)	TW2S ('Tigress' Scooter 12 volt)	54021000	54210946	47135		47128B
(23)	T20 and T20SH	54021025	54213903	47161	54210167	49072A
(24)	T20SR and T20SC	54021039	54213901	47173	54210167	
(25)	3TA, 5TA, 6T, T100SS and T90	54021023	54213901	47164	54210167	49072A
(26)	T100SC	54021052	54214272	47173	54210167	
(27)	T100SC (later)	54021056A	54213901	47188A	54211644	
(28)	TR6SS and T120	54021027	54213901	47162	54210167	49072A
(29)	TR6SS and T120 (U.S.A. only)	54021046	54213901	47183	54210167	49072A





*Zener diode 'Constellation' (12 volt only)

*Alternator serviced by Rotor and Stator

GIRLING EQUIPMENT

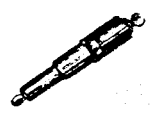



169 170 171 172

1963 SPECIFICATIONS

MAKE AND MODEL		SUSPENSION UNIT 	FERRULE BUSH AND TUBE ASSEMBLY 	SPRING 	OUTER DIRT SHIELD 
(1)	A.J.S. 200 c.c. 5 and 250 c.c. 6 and 65	64054491 (SB4)	9054/316A	9054/70	9054/151A
(2)	250 c.c. 14	64053911 (SB4)	9054/316N	9054/277	9054/151A
(3)	250 c.c. 14CS	64054000 (SB3)	9054/316N	9054/58	9054/151A
(4)	350 c.c. 8	64054163 (SB3)	9054/316N	9054/53	9054/151A
(5)	350 c.c. 16	64054493 (SB4)	9054/316A	9054/70	9054/151A
(6)	500 c.c. 18	64054493 (SB4)	9054/316A	9054/70	9054/151A
(7)	650 c.c. 31	64054493 (SB4)	9054/316A	9054/70	9054/151A
(8)	500 c.c. 18CS	64054392 (SB4)	9054/316A (top) 9054/316N (bottom)	9054/280	9054/295
(9)	650 c.c. 31CS	SB3.5/206	9054/316A (top) 9054/219 (bottom) 9054/307-8 (sleeves)	9054/312	9054/151A
(10)	650 c.c. 31CSR	64054493 (SB4)	9054/316A	9054/70	9054/151A

GIRLING EQUIPMENT

1963 SPECIFICATIONS

		169	170	171	172
MAKE AND MODEL		SUSPENSION UNIT 	FERRULE BUSH AND TUBE ASSEMBLY 	SPRING 	OUTER DIRT SHIELD 
	B.S.A.				
(1)	175 c.c. D7 'Bantam'	64053983 (SC3)	9054/316A (top) 9054/319V (bottom)		
(2)	175 c.c. and 250 c.c. 'Sunbeam' Scooter ...	64053950 (SB4)	9054/316A	64540471	
(3)	250 c.c. C15	64053974 (SC2.6)	9054/316A (top) 9054/316V (bottom)		
(4)	250 c.c. C15 Sports	64054445 (SB3)	9054/316A (top) 9054/316J (bottom)	9054/58	9054/47
(5)	250 c.c. C15T Trials	64054129 (SC3)	9054/316A (top) 9054/316V (bottom)		
(6)	350 c.c. B32 and B32GS	64053904 (SB4)	9054/316A	9054/59	9054/151A
(7)	350 c.c. B40	64054129 (SC3)	9054/316A (top) 9054/316J (bottom)		
(8)	500 c.c. B34 and B34GS	64053804 (SB4)	9054/316A	9054/59	9054/151A
(9)	500 c.c. A7	64053805	9054/316A	9054/70	9054/151A
(10)	500 c.c. A7SS	64053806 (SB4)	9054/316A	9054/63	9054/151A
(11)	500 c.c. A50	64054475	9054/316A	9054/94	9054/150A
(12)	650 c.c. A10 and A10GF	64053805	9054/316A	9054/70	9054/151A
(13)	650 c.c. A65	64054475	9054/316A	9054/94	9054/150A
	ENFIELD				
(14)	'Crusader' and 'Super Sports 5'	64053811 (SB3)	9054/316H	9054/277	9054/152S
(15)	500 c.c. 'Meteor Minor' and Sports	64054090	9054/316H	9054/277	9054/152A
(16)	'Crusader Sports'	64054502 (SB3)	9054/316H	9054/312	9054/47
	JAMES				
(17)	Scooter (front)	64054331 (D4)	9054/316N		
(18)	Scooter (rear)	64054266 (SC3.8)	9054/316N (top) 9054/316J (bottom)		
(19)	98 c.c. 'Comet' and 149 c.c. 'Flying Cadet' ...	D3/201	9054/316A		
(20)	199 c.c. 'Captain'	64054198 (SC3.8)	9054/316L		
(21)	249 c.c. 'Commodore'	64054258 (SC3.8)	9054/316J		
	MATCHLESS				
(22)	200 c.c. G1 and 250 c.c. G4 and G4S	64054491 (SB4)	9054/316A	9054/70	9054/151A
(23)	250 c.c. G2	64053911 (SB4)	9054/316N	9054/277	9054/151A
(24)	250 c.c. G2CS	64054000 (SB3)	9054/316N	9054/58	9054/151A
(25)	350 c.c. G3	64054493 (SB4)	9054/316A	9054/70	9054/151A
(26)	500 c.c. G80	64054493 (SB4)	9054/316A	9054/70	9054/151A
(27)	650 c.c. G12	64054493 (SB4)	9054/316A	9054/70	9054/151A
(28)	500 c.c. G80CS	64054392 (SB4)	9054/316A (top) 9054/316N (bottom)	9054/277	9054/151A
(29)	650 c.c. G12CS	SB3.5/206	9054/316A (top) 9054/219 (bottom) 9054/307-8 (sleeves)	9054/280	9054/295
(30)	650 c.c. G12CSR	64054493 (SB4)	9054/316A	9054/70	9054/151A
	NORTON				
(31)	250 c.c. 'Jubilee'	64053939 (SB3)	9054/316L	9054/58	9054/151A
(32)	350 c.c. 'Navigator'	64054359 (SB3)	9054/316L	9054/58	9054/151AV
(32)	350 c.c. 50 and 500 c.c. E52	64054174 (SB3)	9054/316L (top) 9054/316G (bottom)	9054/277	9054/151AV
(34)	'Dominor' Models, 'Manxman' and 'Atlas' ...	64054174 (SB3) 64054422 (SB3) 64054423 (SB3)	9054/316L (top) 9054/316G (bottom)	9054/277	9054/151AV 9054/151F 9054/151A
	TRIUMPH				
(35)	100 c.c. 'Tina' Scooter	64054406 (SC2.6)	9054/316A		
(36)	200 c.c. 'Tiger Cub' T20C	64054441 (SB3)	9054/316A (top) 9054/316J (bottom)	9054/317	9054/151A
(37)	175 c.c. and 250 c.c. 'Tigress' Scooter	64053950 (SB4)	9054/316A	64540471	
(38)	200 c.c. T20 'Tiger Cub'	SC3/204	9054/316A (top) 9054/316J (bottom)		
(39)	350 c.c. 3TA 'Twenty-one'	64053946 (SB3)	9054/316A	64539963	9054/151A
(40)	500 c.c. 5TA 'Speed Twin'	64054200 (SB3)	9054/316A	64539963	9054/151A
(41)	650 c.c. 6T and T120	64054506 (SB4)	9054/316A	SA253/5	9054/151A

WADING MAGNETOS

The wading units summarised below have in some cases a wider vehicle application than that specified in the Magneto Section. The full application is shown hereunder.

These competition magnetos are manufactured to precision engineering standards, by expert craftsmen, from the best available materials.

MOTOR CYCLE	MAGNETO TYPE	PART No.
A.J.S. and Matchless, single cylinder ...	NCI	42347
A.J.S. and Matchless, single cylinder (America only)	NCI	42371
B.S.A. B34 Racing	KNRI	42123
B.S.A. B34 Competition	KNCI	42348
Enfield 'Bullet' Trials and Scrambles ...	KNCI	42349
Indian 'Westerner' and 'Woodsman' ...	NCI	42371
Norton 88SS 'Dominator'	K2FC	42350
Triumph TR6 Trophy and T120	K2FC	42350
Triumph TR6 Trophy and T120 (America only)	K2FC	42368
Triumph TR6 Racing	K2FR	42324

MODELS 1963

A.J.S.

- 200 c.c. Model 5.
- 250 c.c. Model 6.
- 250 c.c. Model 6S.
- 350 c.c. O.H.V., single cylinder, Model 16 'Sceptre'.
- 350 c.c. O.H.V., single cylinder, Model 16C 'Experts'.
- 500 c.c., O.H.V., single cylinder, Model 18 'Statesman'.
- 500 c.c., O.H.V., single cylinder, Model 18CS 'Southerner'.
- 650 c.c., O.H.V., twin cylinder, Model 31 'Swift'.
- 650 c.c., O.H.V., twin cylinder, Model 31CSR 'Hurricane'.

In the body of the catalogue, the term 'Competition Models' indicates machines as above bearing the model suffix letters C, CS and CSR.

ARIEL

- 250 c.c., two-stroke, twin cylinder, 'Leader'.
- 250 c.c., two-stroke, twin cylinder, 'Arrow' and 'Super Sports'.

B.S.A.

- 125 c.c., two-stroke, single cylinder, Model D1 'Bantam'.
- 175 c.c., two-stroke, single cylinder, Model D7 'Super Bantam'.
- 175 c.c., two-stroke, single cylinder, Model B1 'Sunbeam' Scooter.
- 250 c.c., O.H.V., twin cylinder, Model B2 'Sunbeam' Scooter (6 volt).
- 250 c.c., O.H.V., twin cylinder, Model B2S 'Sunbeam' Scooter (12 volt).
- 250 c.c., O.H.V., single cylinder, Model C15 'Star'.
- 250 c.c., O.H.V., single cylinder, Model C15S and C15T Competition.
- 250 c.c., O.H.V., single cylinder, Model SS80 'Sports Star'.
- 350 c.c., O.H.V., single cylinder, Model B40 'Star' and B40SS90 'Sports Star'.
- 500 c.c., O.H.V., single cylinder, Model B34 'Gold Star' and Competition.
- 500 c.c., O.H.V., twin cylinder, Model A50 'Star'.
- 600 c.c., S.V., single cylinder, Model M21.
- 650 c.c., O.H.V., twin cylinder, Model A10 'Golden Flash'.
- 650 c.c., O.H.V., twin cylinder, Model A10 'Super Rocket'.
- 650 c.c., O.H.V., twin cylinder, 'Rocket Gold Star'.
- 650 c.c., O.H.V., twin cylinder, Model A65 'Star'.

ENFIELD

- 250 c.c., O.H.V., single cylinder, 'Continental'.
- 250 c.c., O.H.V., single cylinder, 'Clipper'.
- 250 c.c., O.H.V., single cylinder, 'Crusader Sports'.
- 250 c.c., O.H.V., single cylinder, 'Super Sports 5'.
- 350 c.c., O.H.V., single cylinder, 'Bullet'.
- 500 c.c., O.H.V., twin cylinder, 'Sports Twin'.
- 700 c.c., O.H.V., twin cylinder, 'Constellation'.
- 736 c.c., O.H.V., twin cylinder, 'Interceptor'.

INDIAN

- 500 c.c., O.H.V., single cylinder, 'Westerner' or 'Woodsman' (as Matchless G80CS).
- 650 c.c., O.H.V., twin cylinder, 'Trailblazer' (as Matchless G12).
- 650 c.c., O.H.V., twin cylinder, 'Apache' (as Matchless G12CSR).

JAMES

- 98 c.c., two-stroke, single cylinder, Model L1 'Comet'.
- 149 c.c., two-stroke, single cylinder, Model L15A 'Flying Cadet'.
- 149 c.c., two-stroke, single cylinder, Model SCI Scooter.
- 199 c.c., two-stroke, single cylinder, Model L20 'Captain'.
- 249 c.c., two-stroke, single cylinder, Model L25 'Commodore'.

MATCHLESS

- 200 c.c., Model G1.
- 250 c.c., Model G4.
- 250 c.c., Model G4S.
- 350 c.c., O.H.V., single cylinder, Model G3 'Mercury'.
- 350 c.c., O.H.V., single cylinder, Model G3C 'Maestro'.
- 500 c.c., O.H.V., single cylinder, Model G80 'Major'.
- 500 c.c., O.H.V., single cylinder, Model G80CS 'Marksman'.
- 650 c.c., O.H.V., twin cylinder, Model G12 'Majestic'.
- 650 c.c., O.H.V., twin cylinder, Model G12CSR 'Monarch'.

In the body of the catalogue, the term 'Competition Models' indicates machines as above bearing the model suffix letters, C, CS and CSR.

NORTON

- 250 c.c., O.H.V., twin cylinder, 'Jubilee'.
- 348 c.c., O.H.V., single cylinder, Model 50.
- 349 c.c., O.H.V., twin cylinder, 'Navigator'.
- 397 c.c., O.H.V., twin cylinder, 'Electra 400'.
- 490 c.c., O.H.V., single cylinder, Model ES2.
- 490 c.c., O.H.V., twin cylinder, Model 88 'Dominator'.
- 490 c.c., O.H.V., twin cylinder, Model 88SS 'Dominator'.
- 650 c.c., O.H.V., twin cylinder, Model 650 'Dominator'.
- 650 c.c., O.H.V., twin cylinder, Model 650SS 'Dominator'.
- 650 c.c., O.H.V., twin cylinder, 'Manxman' (U.S.A. only).
- 745 c.c., O.H.V., twin cylinder, 'Atlas' (U.S.A. only).

PANTHER

- 175 c.c., two-stroke, single cylinder, 'Princess' Scooter (6 volt).
- 250 c.c., two-stroke, twin cylinder, Model 35.
- 324 c.c., two-stroke, twin cylinder, Model 45.
- 600 c.c., O.H.V., single cylinder, Model 100.
- 650 c.c. O.H.V., single cylinder, Model 120.

TRIUMPH

- 100 c.c., two-stroke, single cylinder, Model 'Tina' Scooter.
- 173 c.c., two-stroke, single cylinder, Model T51 'Tigress' Scooter.
- 200 c.c., O.H.V., single cylinder, Model T20 'Tiger Cub'.
- 200 c.c., O.H.V., single cylinder, Models T20SR, T20SC and T20C.
- 200 c.c., O.H.V., single cylinder, Model T20SH 'Tiger Cub'.
- 250 c.c., O.H.V., twin cylinder, Model TW2 'Tigress' Scooter (6 volt).
- 250 c.c., O.H.V., twin cylinder, Model TW2S 'Tigress' Scooter (12 volt).
- 350 c.c., O.H.V., twin cylinder, Model 3TA 'Twenty-one'.
- 350 c.c., O.H.V., twin cylinder, Model T90 'Tiger'.
- 500 c.c., O.H.V., twin cylinder, Model 5TA 'Speed Twin'.
- 500 c.c., O.H.V., twin cylinder, Model T100SC 'Tiger' (U.S.A. only).
- 500 c.c., O.H.V., twin cylinder, Model T100SS 'Tiger'.
- 650 c.c., O.H.V., twin cylinder, Model TR6SS 'Trophy'.
- 650 c.c., O.H.V., twin cylinder, Model T120 'Bonneville'.
- 650 c.c., O.H.V., twin cylinder, Model 6T 'Thunderbird'.