

LUCAS

Quality

EQUIPMENT

& SPARE PARTS

for

MOTOR CYCLES

1958-1962



LUCAS

SERVICE DEPOTS

SALES AND SERVICE DEPOTS

For the convenience of users of all Lucas articles—particularly our Electrical Equipment—we have established the under-mentioned Service Depots, where urgent repairs and general overhauls are dealt with by experienced staffs.

ACTON, LONDON Telephone: Shepherds Bush 3160	Telex No.: 21386	Dordrecht Road, Acton Vale, W.3 Telegrams: "Lucaserv, London, Telex"
BELFAST Telephone: Belfast 25617	Telex No.: 74519	51-55 Upper Library Street Telegrams: "Lucaserv, Belfast, Telex"
BIRMINGHAM 18 Telephone: Central 5050	Telex Nos.: 33103 and 33528	Great Hampton Street Telegrams: "Lucaserv, Birmingham, Telex"
BRIGHTON 4 Telephone: Hove 772341-6	Telex No.: 87246	85 Old Shoreham Road, Hove Telegrams: "Lucaserv, Hove, Telex"
BRISTOL 4 Telephone: Bristol 79311	Telex No.: 44245	345 Bath Road Telegrams: "Lucaserv, Bristol, Telex"
CAMBRIDGE Telephone: Cambridge 51251	Telex No.: 81139	Newmarket Road Telegrams: "Lucaserv, Cambridge, Telex"
CARDIFF Telephone: Cardiff 28161	Telex No.: 49325	54a Penarth Road Telegrams: "Lucaserv, Cardiff, Telex"
CORK (Distribution Depot) Telephone: Cork 21981		Bachelors Quay Telegrams: "Lucaserv, Cork"
COVENTRY Telephone: Bedworth 3077		Coventry Road, Exhall Telegrams: "Lucaserv, Coventry"
DUBLIN Telephone: Dublin 46195-8	Telex No.: 235	Portland Street North, North Circular Road Telegrams: "Lucaserv, Dublin, Telex"
EDINBURGH 11 Telephone: Donaldson 2311	Telex No.: 72161	60 Stevenson Road, Gorgie Telegrams: "Lucaserv, Edinburgh, Telex"
GLASGOW C.3 Telephone: Douglas 6591-7	Telex No.: 77381	4-24 Grant Street (St. George's Road) Telegrams: "Lucaserv, Glasgow, Telex"
LEEDS 8 Telephone: Leeds 28591	Telex No.: 55172	64 Roseville Road Telegrams: "Lucaserv, Leeds, Telex"
LIVERPOOL 13 Telephone: Stonycroft 4721	Telex No.: 62430	450-470 Edge Lane Telegrams: "Lucaserv, Liverpool, Telex"
LONDONDERRY Telephone: Londonderry 4621		119 Duncreggan Road Telegrams: "Lucaserv, Londonderry"
MANCHESTER Telephone: Longford 1101	Telex No.: 66715	Talbot Road, Stretford Telegrams: "Lucaserv, Manchester, Telex"
NEWCASTLE-ON-TYNE 1 Telephone: Newcastle 25571	Telex No.: 53147	64-68 St. Mary's Place Telegrams: "Lucaserv, Newcastle-on-Tyne, Telex"
WOODFORD GREEN Telephone: Crescent 6711-5	Telex No.: 24358	Southend Road, Woodford Green, Essex Telegrams: "Lucaserv, Woodford Green, Telex"
LONDON—SALES OFFICE Telephone: Langham 4311		319 Regent Street, W.1 Telegrams: "Guidepost, Wesdo, London"
LONDON—LUCAS CENTRAL EXPORT DIVISION Telephone: Grosvenor 4491	Telex No.: 25386	46 Park Street, W.1 Telegrams: "Lucasland, London, Telex" Cables: "Lucasland, London W.1"

THE ORGANISATION OVERSEAS:

JOSEPH LUCAS (AUSTRALIA) PTY. LIMITED
EQUIPAMENTOS JOSEPH LUCAS DO BRASIL LTDA.
JOSEPH LUCAS (CANADA) LIMITED
SOCIETE FRANCAISE DES INDUSTRIES LUCAS
JOSEPH LUCAS (GERMANY) G.m.b.H.
LUCAS INDIAN SERVICE (PRIVATE) LIMITED, INDIA
LUCAS ELECTRICAL TRACTOR SERVICE
(PRIVATE) LIMITED, INDIA
JOSEPH LUCAS ITALIANA S.p.A.
ASSOCIATED BATTERIES MALAYA LTD.
JOSEPH LUCAS MALAYA LTD.

REFACCIONES BRITANICOS, S.A., MEXICO
JOSEPH LUCAS (NEW ZEALAND) LIMITED
LUCAS SERVICE (PAKISTAN) LIMITED
LUCAS (AMERICA LATINA) S.A., PANAMA
JOSEPH LUCAS C.A. (PVT.) LTD., CENTRAL AFRICA
JOSEPH LUCAS PTY. LIMITED, SOUTH AFRICA
LUCAS BATTERIES PTY. LIMITED, SOUTH AFRICA
LUCAS NORDISKA AKTIEBOLAG, SWEDEN
JOSEPH LUCAS LIMITED (ZURICH)
LUCAS ELECTRICAL SERVICES INC., U.S.A.

WORLD-WIDE SERVICE

The Lucas Overseas Service Organisation is world-wide. In the Argentine, Australia, Canada, Eire, France, India, New Zealand, Pakistan, South Africa, Switzerland and U.S.A., we have established our own subsidiary companies. There are Lucas Service Agents with fully-equipped Service Stations in the principal cities and main centres throughout the world, so that adequate service and spare parts are available wherever British cars, motor cycles and vehicles are sold. At home in Great Britain, in addition to our own Lucas Service Depots given above, there are over four hundred Official Service Agents throughout the country. A separate publication, No. 2023, gives full details of the Lucas Overseas Service Organisation.

Compiled and issued by Technical Records Department, Joseph Lucas (Sales and Service) Ltd., Great Hampton Street
Birmingham 18.

© 1963 Printed in England

JOSEPH LUCAS LTD · BIRMINGHAM · ENGLAND



FOREWORD

This new issue of the 716 Catalogue lists Lucas equipment and spare parts for 1958-1962 motor cycles, used in conjunction with the previous edition, gives comprehensive parts information for all motor cycles from 1936-1962. The illustrations included in this supplement at the end of each section, are of new items of equipment only, which have been introduced since 1958. For illustrations of all other equipment refer to the previous edition, Master Catalogue No. 716A.

GUIDANCE FOR ORDERING SPARE PARTS

It will be readily appreciated that the correct ordering of units or spare parts speeds the handling of our customers' requirements through Agents, Stockists and Depots, etc. It is, therefore, important to quote the part number, which on most units is clearly marked. If, for any reason, it is not possible to do this, or should there be any doubt about it, always quote the MAKE AND MODEL OF MOTOR CYCLE, CYLINDER CAPACITY IN CUBIC CENTIMETRES (e.g. 350 c.c.) and YEAR OF MANUFACTURE. It must be clearly understood that with this information before us we are only able to send equipment which was fitted as standard.

HOW TO USE THIS CATALOGUE

Your customers' order for spare parts will most likely fall into one of the following four categories:

- | | |
|--|---|
| (a) Details of motor cycle only given. | (c) Supply to sample. |
| (b) Part number of complete unit quoted
(but not part number of spare part required). | (d) Part number of spare part, but no
further details. |

This catalogue attempts to meet all the above contingencies as follows:

- A. The Motor Cycle Equipment Guide contains complete individual specifications for each motor cycle from 1958-1962 inclusive. It is, therefore, only necessary to refer to the appropriate page to find the part number of any particular LUCAS unit. Let us assume that a contact set is required for a distributor fitted to a B.S.A. C15 'Star' 1960. Details of this motor cycle are given on page A5 and the part number of the distributor is given as 40621B. Turning to the Ignition Section of the catalogue, detailed spare parts for this distributor will be found on page F5, where the part number of the contact set required is shown as 421106.
- B. As the part number of complete unit is known, turn to Spare Parts Section concerned. For example, brush set required for generator, part number 20010K: turn to Generator Section, where all units are tabulated numerically; having located 20010K, run down left hand descriptive column for brush sets, part number required will be 200737.
- C. As will be seen from the Section Index, this catalogue is made up of distinct sections, each dealing with a separate LUCAS unit (Generator, Magneto, Lamp, etc.). Furthermore, in each section all similar parts are photographed in groups, i.e., contact sets, pick-ups, etc. Therefore identification of samples by means of these illustrations becomes much simpler. Failing this, further information must be obtained as in A or B above.
- D. A complete list of part numbers in order is given in the Numerical Index, Section K, together with the page numbers on which details of the parts can be found. Find part number required, and all sections of catalogue where part number appears will be indicated by the page references.

SUPERSESSION CHARTS FOR UNITS AND PARTS

It will be appreciated that many of the older units and components are no longer available, and every endeavour is made to replace them with more modern and improved types. It should, perhaps, be emphasised that the components selected will always satisfactorily replace those originally fitted. For details of latest replacements see comprehensive Supersession Chart. Section J.

ALTERATIONS TO PRICES AND SPECIFICATIONS

We reserve the right to alter any prices or specifications at any time without notice. All goods are sold subject to prices and conditions ruling at the time of delivery.

ORDERING QUANTITIES

Please state clearly quantity required. For example: 1 or 6; 1 packet or 6 packets. Certain components are supplied in packets of 10. Large quantities of such items should be ordered in packet multiples. For example: 1 packet = 10 pieces; 6 packets = 60 pieces.

EXHIBITION

The goods listed herein are sold on the condition that they are not to be exhibited by any person, firm or company at any exhibition without our written authority.

TELEGRAPHIC CODES

It is usually necessary to telegraph only in cases of urgency. To save time and expense, we suggest that the following codes be used:

LABAR ..	Send by post.	LACH ..	Send by registered post.
LACER ..	Send by parcel post.	AIRMA ..	Send by air mail.

USE OF PATTERNS

When parts are sent to us as patterns they should be carefully labelled, indicating the name and address of the sender, together with reference or order number, which will enable us to deal with the matter properly. In all cases an indication should be given of the unit from which the part has been removed.

GUARANTEE

All usual and reasonable precautions have been taken to ensure excellence of materials and workmanship, and in the event of any defect which is not caused by wear and tear, misuse, accident, or negligence, being disclosed within twelve months of its being put into use, we will either supply new parts or components in exchange for those defective, or repair such defective parts or components, free of charge. We do not undertake to dismantle or reassemble, or bear the cost of dismantling or reassembling any such part or component on the vehicle or chassis. This undertaking shall be deemed to exclude any and every other obligation whatsoever, and all liability for any loss or damage, howsoever or whensoever caused or arising, except the cost of replacement or repair in accordance with this undertaking.

CONDITIONS OF SALE

Any LUCAS article, whether bought direct from us or from a dealer, is supplied upon condition that it shall not be resold TO THE TRADE below the LOWEST FIXED WHOLESALE SELLING PRICE, or to any person other than a bona-fide dealer below the LOWEST FIXED RETAIL SELLING PRICE of it appearing in our printed List of Lowest Fixed Prices for the season current at the time of the resale; that any such resale shall be subject to these Conditions; and that if any such resale be made below the proper Lowest Fixed Selling Price—the dealer so reselling it will be liable to pay us the sum of FIVE POUNDS as liquidated damages.

RESTRICTIVE TRADE PRACTICES ACT 1956

We hereby give notice for the purposes of S. 25 of the Restrictive Trade Practices Act 1956 of the resale price condition to which all LUCAS goods are subject.

JOSEPH LUCAS LIMITED · BIRMINGHAM 19 · ENGLAND



EQUIPMENT SPECIFICATIONS WITH INDEX

A

**AMMETERS, BATTERIES AND SPARES, CABLES AND
CABLE SUNDRIES**

B

CONTROL BOXES AND REGULATORS

C

**ALTERNATORS, ROTORS, STATORS, GENERATORS AND
RECTIFIERS**

D

**ELECTRIC HORNS, HORN PUSHES, HORN PUSH AND
DIPPER SWITCHES**

E

**AUTO-ADVANCE UNITS, CONTACT BREAKER UNITS,
DISTRIBUTORS AND H.T. COILS, MAGNETOS AND
MAGDYNOS, SUPPRESSORS, STARTING MOTORS**

F

**LAMPS: HEAD, SIDE, SIDECAR, FLASHER, PILOT, TAIL,
STOP TAIL, FOG, DRIVING, INSPECTION AND NUMBER
PLATE, WARNING LIGHTS, REFLEX REFLECTORS, BULBS**

G

SWITCHES

H

SUPERSESSION CHART

J

NUMERICAL INDEX

K



EQUIPMENT SPECIFICATIONS. For complete specifications of LUCAS equipment fitted to motor cycles, see pages A1 - A21.

NUMERICAL INDEX. For complete list of all part numbers, in numerical order, appearing in this catalogue, see Section K.

	Page No.		Page No.
Alternators (see Stators)	D2	LAMPS—continued	
Ammeters	B1	Driving	G28-29
Auto-advance units	F6	Inspection	G30
Batteries and spares	B1-4	Magneto (flywheel) and generator	F6
Fillers, battery	B3	7F1 and 8F1 Models	F6
Bulbs, lamp	G26-27	Magnetos	F6-10
Cables	B5-6	Competition Models	F9-10
Cable wiring sundries (Lucar connectors) ..	B7	K1FC, KNCL, KNRL and NCL	
Coils, ignition	F3	Models	F9-10
Control boxes	C1	K2FC and K2FR Models	F9-10
Contact breaker units	F2	K1F, K2F and N14 Models	F7-8
CA1A, 3CA, 4CA and 4CC	F2	SR1 and SR2 Models	F6
Distributors	F4-5	Magdynos	F11
Generators	D1	MO1L Model	F11
Horns	E1-4	Rectifiers	D2
Brackets, horn	E2	Rotors	D1
Horn pushes	H2	Starting motors	F3
Horn pushes and dipper switches	H2	Stators (Alternator)	D2
LAMPS	G1-29	Suppressors	F3
Head	G2-23	SWITCHES and KNOBS	H1-5
Tail and number plate	G24	Cutout, magneto	H4
Stop tail and number plate	G24	Dipper and indicator	H2
Stop tail, number plate and reflex	G24	Ignition	H4
Reflex reflectors	G26	Lighting and ignition	H3
Side, flasher or pilot	G25, G30	Lighting	H2-3
Sidecar	G25	Starter	H3
Fog	G28-29	Stop lamp	H3
		Springs, stop lamp switch	H3
		Warning lights	G25

LUCAS

A

Vehicle	Year	Page No.	Vehicle	Year	Page No.
A.J.S.			B.S.A.—continued		
250 c.c. o.h.v. '14 Sapphire'	1959-62	A1	250 c.c. o.h.v. 'SS80 Sports Star' ..	1961-62	A5
250 c.c. o.h.v. '14S Sapphire Sports' ..	1959-62	A1	350 c.c. o.h.v. 'B31'	1958-59	A6
250 c.c. o.h.v. 'Scorpion'	1959-62	A1	350 c.c. o.h.v. 'B32 Gold Star' and Competition	1958-62	A6
350 c.c. o.h.v. '8 Senator'	1960-62	A1	350 c.c. o.h.v. 'B40 Star'	1961-62	A6
350 c.c. o.h.v. '16MS'	1958	A1	500 c.c. o.h.v. 'B33'	1958-60	A6
350 c.c. o.h.v. '16 Sceptre'	1959-62	A1	500 c.c. o.h.v. 'B34 Gold Star' and Competition	1958-62	A6
350 c.c. o.h.v. '16S Sceptre Sports' ..	1959-62	A1	500 c.c. s.v. 'M20'	1958-62	A6-7
350 c.c. o.h.v. '16MCS'	1958-62	A1	500 c.c. o.h.v. Twin 'A7'	1958-62	A7
350 c.c. o.h.v. '16C'	1958-62	A1	500 c.c. o.h.v. Twin 'A7 Shooting Star'	1958-62	A7
350 c.c. o.h.v. '16CS'	1958-62	A1	500 c.c. o.h.v. Twin 'A50 Star' ..	1962	A7
350 c.c. o.h.v. '16C Experts'	1958-62	A1	600 c.c. s.v. 'M21'	1958-62	A6-7
500 c.c. o.h.v. '18'	1958-62	A1	650 c.c. o.h.v. Twin 'A10 Golden Flash'	1958-62	A7
500 c.c. o.h.v. '18S Statesman'	1958-62	A1	650 c.c. o.h.v. Twin 'A10 Road Rocket'	1958	A7
500 c.c. o.h.v. '18CS'	1958-62	A1-2	650 c.c. o.h.v. Twin 'A10 Super Rocket'	1959-62	A7
500 c.c. o.h.v. '18CT'	1958-62	A1-2	650 c.c. o.h.v. Twin 'Rocket Gold Star'	1962	A7
500 c.c. o.h.v. '18CS Southerner' ..	1958-62	A1-2	650 c.c. o.h.v. Twin 'A65 Star' ..	1962	A7
500 c.c. o.h.v. Twin '20'	1958-61	A2	DOUGLAS		
500 c.c. o.h.v. Twin '20 De Luxe' ..	1959	A2	125 c.c. 'Vespa'	1958-62	A7
500 c.c. o.h.v. Twin '20CS'	1959	A2-3	150 c.c. 'Vespa'	1958-62	A7
500 c.c. o.h.v. Twin '20CSR'	1959	A2-3	ENFIELD		
600 c.c. o.h.v. Twin '30'	1958	A2	148 c.c. t.s. 'Ensign'	1959	A7
650 c.c. o.h.v. Twin '31 Swift'	1959-62	A2	148 c.c. t.s. 'Prince'	1959-62	A7
650 c.c. o.h.v. Twin '31 De Luxe' ..	1959-61	A2	250 c.c. o.h.v. 'Clipper'	1958-62	A7-8
650 c.c. o.h.v. Twin '31CS'	1959-62	A2-3	250 c.c. o.h.v. 'Crusader'	1958-62	A8
650 c.c. o.h.v. Twin '31CSR Hurricane'	1959-62	A2-3	250 c.c. o.h.v. 'Crusader Sports' ..	1959-62	A8
ARIEL			250 c.c. o.h.v. 'Crusader Super Sports 5'	1962	A8
250 c.c. t.s. 'Leader'	1958-62	A3	350 c.c. o.h.v. 'G2 Madras'	1958-62	A8
250 c.c. t.s. 'Arrow'	1960-62	A3	350 c.c. o.h.v. 'Bullet'	1958-62	A9
250 c.c. t.s. 'Super Sports Arrow' ..	1961-62	A3	350 c.c. o.h.v. 'Clipper'	1958-62	A9
350 c.c. o.h.v. 'NH Red Hunter'	1958-59	A3-4	350 c.c. o.h.v. Trials 'Scrambler' ..	1958-62	A9
500 c.c. o.h.v. 'VH Red Hunter'	1958-59	A3-4	500 c.c. o.h.v. Trials 'Scrambler' ..	1958-62	A9
500 c.c. o.h.v. 'HS Scrambles Mk. III'	1958	A4	500 c.c. o.h.v. 'Bullet'	1958-62	A9
500 c.c. o.h.v. 'HS Red Hunter' Scrambles	1958-59	A4	500 c.c. o.h.v. 'Fury' ('Scrambler', U.S.A. only)	1961	A10
500 c.c. o.h.v. 'HTS Red Hunter Trials'	1959	A4	500 c.c. o.h.v. Twin	1958	A10
600 c.c. s.v. 'VB'	1958	A4	500 c.c. o.h.v. Twin 'Meteor Minor' ..	1958-62	A10
650 c.c. o.h.v. Twin 'FH Huntmaster'	1958-59	A4	500 c.c. o.h.v. Twin 'Meteor Minor De Luxe'	1960-62	A10
1,000 c.c. s.v. '4G Square Four' ..	1958-59	A4	500 c.c. o.h.v. Twin 'Meteor Minor Sports'	1960-62	A10
B.S.A.			700 c.c. o.h.v. Twin 'Super Meteor' ..	1958-62	A10
70 c.c. 'Dandy'	1958-59	A4	700 c.c. o.h.v. Twin 'Constellation' ..	1958-62	A10-11
125 c.c. 'D1 Bantam'	1958-62	A4	FRANCIS BARNETT		
150 c.c. 'D3 Bantam Major'	1958	A4	172 c.c. t.s. 'Light Cruiser 79'	1959-60	A11
175 c.c. 'D5 Bantam Super'	1958	A4	197 c.c. t.s. 'Falcon 81'	1958-59	A11
175 c.c. 'D7 Bantam Super'	1959-62	A4	199 c.c. t.s. 'Falcon 87'	1960-61	A11
175 c.c. 'B1 Sunbeam' Scooter	1959-62	A5	249 c.c. t.s. 'Cruiser 80'	1958-61	A11
250 c.c. 'B2 Sunbeam' Scooter	1959-62	A5	249 c.c. t.s. 'Cruiser 84'	1959-61	A11
250 c.c. 'B2S Sunbeam' Scooter	1959-62	A5	249 c.c. t.s. 'Trials 83'	1959	A11
250 c.c. o.h.v. 'C12 Star'	1958	A5	249 c.c. t.s. 'Trials 85'	1960-61	A11
250 c.c. o.h.v. 'C15 Star'	1959-62	A5	249 c.c. t.s. 'Scrambles 82'	1959-61	A11
250 c.c. o.h.v. 'C15S Scrambles' ..	1959-62	A5-6			
250 c.c. o.h.v. 'C15T Trials'	1959-62	A5-6			



Vehicle	Year	Page No.
INDIAN		
250 c.c. o.h.v. 'Fire Arrow' ('Hounds')	1958	A11
350 c.c. o.h.v. 'Westerner'	1959	A11
500 c.c. o.h.v. 'Westerner'	1959	A11
500 c.c. o.h.v. 'Tomahawk'	1958	A11-12
500 c.c. o.h.v. 'Woodsman'	1958	A12
700 c.c. o.h.v. Twin 'Trail Blazer' ..	1958	A12
700 c.c. o.h.v. Twin 'Apache'	1958-59	A12
700 c.c. o.h.v. Twin 'Chief'	1959	A12
For 1960-62 Models, see specification section A12.		
JAMES		
98 c.c. t.s. 'Comet L1'	1958-62	A12
147 c.c. t.s. 'Cadet L15'	1958-59	A12-13
149 c.c. t.s. 'Flying Cadet L15A' ..	1960-62	A12-13
149 c.c. t.s. Scooter 'SCI'	1962	A13
175 c.c. t.s. 'Cavalier L17'	1958-59	A13
197 c.c. t.s. 'Captain K7'	1958-59	A13
199 c.c. t.s. 'Captain L20'	1960-62	A13
199 c.c. t.s. 'Sports Captain L20S' ..	1962	A13
249 t.s. 'Commodore L25'	1960-62	A13
249 c.c. t.s. 'Super Swift M25' ..	1962	A13
MATCHLESS		
250 c.c. o.h.v. 'G2'	1959-62	A13
250 c.c. o.h.v. 'G2CS Clubman' ..	1959-62	A13
250 c.c. o.h.v. 'G2 Monitor'	1962	A13
250 c.c. o.h.v. 'G2S Monitor Sports' ..	1962	A13
350 c.c. o.h.v. 'G3LS'	1958	A13
350 c.c. o.h.v. 'G3 Mercury'	1959-62	A13
350 c.c. o.h.v. 'G3S Mercury Sports' ..	1959-62	A13
350 c.c. o.h.v. 'G3LCS'	1958-62	A13-14
350 c.c. o.h.v. 'G3C'	1958-62	A13-14
350 c.c. o.h.v. 'G3CS'	1958-62	A13-14
350 c.c. o.h.v. 'G3C Maestro'	1958-62	A13-14
350 c.c. o.h.v. 'G5 Matador'	1960-62	A13
500 c.c. o.h.v. 'G50CSR' (U.S.A. only)	1962	A14
500 c.c. o.h.v. 'G80'	1958-62	A14
500 c.c. o.h.v. 'G80S Major'	1958-62	A14
500 c.c. o.h.v. 'G80CS'	1958-62	A14
500 c.c. o.h.v. 'G80CS Marksman' ..	1958-62	A14
500 c.c. o.h.v. Twin 'G9'	1958-61	A14-15
500 c.c. o.h.v. Twin 'G9 De Luxe' ..	1959	A15
500 c.c. o.h.v. Twin 'G9CS'	1959	A15
500 c.c. o.h.v. Twin 'G9CSR'	1959	A15
600 c.c. o.h.v. Twin 'G11'	1958	A14-15
650 c.c. o.h.v. Twin 'G12 Majestic' ..	1959-62	A14-15
650 c.c. o.h.v. Twin 'G12 De Luxe' ..	1959-61	A15
650 c.c. o.h.v. Twin 'G12CS'	1959-62	A15
650 c.c. o.h.v. 'G12CSR Monarch' ..	1959-62	A15
NORTON		
250 c.c. o.h.v. Twin 'Jubilee'	1960-62	A15
348 c.c. o.h.v. '40 International' ..	1958	A15
348 c.c. o.h.v. '50'	1958-62	A16
350 c.c. o.h.v. Twin 'Navigator'	1961-62	A16
490 c.c. o.h.v. '30 International' ..	1958	A15
490 c.c. o.h.v. 'ES2'	1958-62	A16
497 c.c. o.h.v. Twin '88 Dominator' ..	1958-62	A16
497 c.c. o.h.v. Twin '88SS Dominator'	1962	A16
596 c.c. o.h.v. '19'	1958	A16
597 c.c. o.h.v. Twin 'Nomad' (U.S.A. only)	1958-60	A16
597 c.c. o.h.v. Twin '99 Dominator' ..	1958-62	A16

Vehicle	Year	Page No.
NORTON—continued		
597 c.c. o.h.v. Twin '99SS Dominator'	1962	A16
650 c.c. o.h.v. Twin 'Manxman' (U.S.A. only)	1961-62	A16-17
650 c.c. o.h.v. Twin 'Dominator' ..	1962	A16
650 c.c. o.h.v. Twin 'SS Dominator' ..	1962	A16-17
750 c.c. o.h.v. Twin 'Atlas' (U.S.A. only)	1962	A17
PANTHER (Phelon and Moore)		
175 c.c. t.s. 'Princess' Scooter (6 volt)	1959-62	A17
175 c.c. t.s. 'Princess' Scooter (12 volt)	1959-62	A17
197 c.c. t.s. '10/3'	1959-61	A17
197 c.c. t.s. '10/3A'	1959-62	A17
197 c.c. t.s. '10/4'	1959-62	A17
250 c.c. t.s. Twin '35'	1959-61	A17
250 c.c. t.s. Twin '35 Sports'	1959-62	A17
250 c.c. o.h.v. '65'	1958-61	A17-18
324 c.c. t.s. Twin '45'	1959-62	A18
324 c.c. t.s. Twin '50 Grand Sports' ..	1959-62	A18
350 c.c. o.h.v. '75'	1958-62	A18
600 c.c. o.h.v. '100'	1958-62	A18
650 c.c. o.h.v. '120'	1959-62	A18
RALEIGH		
'Moped'	1958-60	A18
TRIUMPH		
173 c.c. 'Tigress TS' Scooter	1959-62	A18
200 c.c. o.h.v. 'Tiger Cub T20'	1958-62	A18-19
200 c.c. o.h.v. 'Tiger Cub T20C'	1959	A19
200 c.c. o.h.v. 'Tiger Cub T20SL' ..	1961	A19
200 c.c. o.h.v. 'Tiger Cub T20T'	1961	A19
200 c.c. o.h.v. 'Tiger Cub T20SS' ..	1962	A19
200 c.c. o.h.v. 'Tiger Cub T20SR' ..	1962	A19
200 c.c. o.h.v. 'Tiger Cub T20SC' ..	1962	A19
200 c.c. o.h.v. 'Tiger Cub T20SH' ..	1962	A19
250 c.c. 'Tigress TW2' Scooter	1959-62	A19
250 c.c. 'Tigress TW2S' Scooter	1959-62	A19
350 c.c. o.h.v. 'Twenty-one 3TA'	1958-62	A19-20
500 c.c. o.h.v. 'Speed Twin' '5TAC' and '5TA'	1958-62	A19-20
500 c.c. o.h.v. 'Tiger T100'	1958-59	A20
500 c.c. o.h.v. 'Tiger T100A'	1960-61	A20
500 c.c. o.h.v. 'Tiger T100SC' (U.S.A. only)	1962	A20
500 c.c. o.h.v. 'Tiger T100SS'	1962	A20
500 c.c. o.h.v. 'Trophy TR5'	1958-59	A20
500 c.c. o.h.v. 'TR5A-C' (U.S.A. only)	1961	A20
500 c.c. o.h.v. 'TR5A-R' (U.S.A. only)	1961	A20
600 c.c. o.h.v. 'Tiger T110'	1958	A20
650 c.c. o.h.v. 'Tiger T110'	1959-61	A20
650 c.c. o.h.v. 'Trophy TR6, TR6SS' ..	1958-62	A21
650 c.c. o.h.v. 'Thunderbird 6TAC' and '6T'	1958-62	A21
650 c.c. o.h.v. 'Bonneville T120' ..	1959-62	A21
VELOCETTE		
250 c.c. t.s. Twin 'Viceroy' Scooter ..	1960-62	A21
350 c.c. o.h.v. 'Viper'	1958-62	A21
350 c.c. o.h.v. 'MAC'	1958-61	A21
350 c.c. o.h.v. 'Scrambler'	1958-62	A21
500 c.c. o.h.v. 'Venom'	1958-62	A21
500 c.c. o.h.v. 'MSS'	1958-62	A21
500 c.c. o.h.v. 'Scrambler'	1958-62	A21

Equipment Specification

A.J.S. 250 c.c. o.h.v. '14 Sapphire', '14S Sapphire Sports and '14CS Scorpion' 1959-62 350 c.c. o.h.v. '8 Senator' 1960-62

Unit	Year	Part No.	Model
Battery	1959-62	—	PUZ7E-11
Horn	1959-61	*70146B (70142)	HF1849
.. .. .	1962	70163A	8H

A.J.S. 350 c.c. o.h.v. '16MS' 1958 and '16 Sceptre' and '16S Sceptre Sports' 1959-62

Alternator			
Rotor	1958-62	423506	RM15
Stator	1958-62	47122A	RM15
Ammeter (part of headlamp) ..	1958-62	36084F	CZU27
Battery	1958-59	—	PUZ7E-11
.. .. .	1960-61	—	MLZ9E
.. .. .	1962	—	PUZ7E-11
Cable harness	1958-59	865225	—
.. .. .	1960-62	54944148	—
.. .. .	1962	54949913	—
.. .. .	Later	—	—
Coil, ignition	1958-62	45077B/E	MA6
Contact breaker	1958-61	47578D/H	CA1A
.. .. .	1962	47595A	CA1A
Generator	1958-62	20038	E3N
Horn	1958-61	*70137A (70048)	HF1441
.. .. .	1962	70163A	8H
Horn push and dip switch ..	1958-62	31563D	25SA
LAMPS			
Head			
Home and Export, dip left	1958-59	58135A	MCH57
ditto	1960-62	58409A	MCH61
ditto	1962	58702A	MCH61
.. .. .	Later	—	—
Export, vertical dip	1958-59	58136A	MCH57
Export Europe(not France)	1958-59	58137A	MCH57
ditto	1960-62	58514A	MCH61
ditto	1962	58832A	MCH61
Export France	1958-59	58138A	MCH57EF
.. .. .	1960-62	58515A	MCH61EF
.. .. .	1962	58833A	MCH61EF
.. .. .	Later	—	—
Stop tail and number plate and reflex	1958-62	53432B	564
Rectifier	1958-59	*47111A (47132)	FSW1501A
.. .. .	1959-62	47132A/B	FSX1849
Switches			
Ignition (part of headlamp)	1960-62	54033027	63SA
ditto	1962	34287A	88SA
Knob	—	54332498	—
Lighting (part of headlamp)	1960-62	54033109	63SA
ditto	1962	34289A	88SA
Knob	—	54330934	—
Lighting and ignition (part of headlamp)	1958-59	31443E	PRS8
Knob	—	318346	—
Stop lamp	1958-62	31384B	22B
Spring, stop lamp	1958-62	315543	—

A.J.S. 350 c.c. o.h.v. '16MC', '16C', '16CS' and '16C Experts' (Competition Models) 1958-62

Ammeter (part of headlamp) ..	1958-62	36084F	CZU27
Battery	1958-62	—	PUZ7E-11
Cable harness	1958	838671	—
.. .. .	1959-61	54941907	—
.. .. .	1962	54949915	—
Control box	1958	37144A	MCR2
.. .. .	1958	37144B	MCR2
.. .. .	1959-60	37232H	RB108
.. .. .	1960-62	37232J/K	RB108
Generator	1958-62	20038B	E3N
Horn	1958-61	*069446 (54068034)	HF1234
.. .. .	1962	70163A	8H
Horn push	1958-61	76204A	4A
Horn push and dip switch ..	1962	31563D	25SA

continued

The Lucas Equipment shown in the following specifications is that fitted to the machines originally. It will be noted that certain items are starred. These are no longer obtainable, and the part number shown beneath in brackets must be quoted when ordering.

Spare parts for all the units shown in these specifications are tabulated in various sections of this catalogue.

A.J.S. 350 c.c. o.h.v. '16MC', '16C', '16CS' and '16C Experts' (Competition Models) 1958-62 —continued

Unit	Year	Part No.	Model
LAMPS			
Head			
Home and Export	1958	*50791D (51625)	MU42
.. .. .	1959-62	58224D	SSU700P
Stop tail and number plate ..	1958	53432B	564
ditto (U.S.A. only)	1958	53429A	529
ditto	1959-62	53429A/B	529
Magneto	1958-62	*42347D (42371)	NC1
.. .. .	1962-66	*42347E (42371)	NC1
.. .. .	1958-62	*42371A	NC1
.. .. .	1960-62	57116A	RER25
Reflex reflector	1958-62	—	—
Switches			
Dipper	1958-61	31482A	9
Lighting (part of headlamp)	1958	31340A	U39
.. .. .	1959-62	*31754A/B (31763)	41SA
Stop lamp	1958-62	31384B	22B
Spring, stop lamp	—	315543	—

A.J.S. 500 c.c. o.h.v. '18' and '18S Statesman' 1958-62

Alternator			
Rotor	1958-62	423506	RM15
Stator	1958-62	47122A	RM15
Ammeter (part of headlamp) ..	1958-62	36084F	CZU27
Battery	1958-59	—	PUZ7E-11
.. .. .	1960-61	—	MLZ9E
.. .. .	1962	—	PUZ7E-11
Cable harness	1958-59	865225	—
.. .. .	1960-62	54944148	—
.. .. .	1962	54949913	—
.. .. .	Later	—	—
Coil, ignition	1958-62	45077B/E	MA6
Contact breaker	1958-62	47579D/H	CA1A
Horn	1958-61	*70137A (70048)	HF1441
.. .. .	1962	70163A	8H
Horn push and dip switch ..	1958-62	31563D	25SA
LAMPS			
Head			
Home and Export, dip left	1958-59	58135A	MCH57
ditto	1960-62	58409A	MCH61
ditto	1962	58702A	MCH61
.. .. .	Later	—	—
Export, vertical dip	1958-59	58136A	MCH57
Export Europe(not France)	1958-59	58137A	MCH57
ditto	1960-62	58514A	MCH61
ditto	1962	58832A	MCH61
Export France	1958-59	58138A	MCH57EF
.. .. .	1960-62	58515A	MCH61EF
.. .. .	1962	58833A	MCH61EF
.. .. .	Later	—	—
Stop tail and number plate and reflex	1958-62	53432B	564
Rectifier	1958-59	*47111A (47132)	FSW1501A
.. .. .	1959-62	47132A/B	FSX1849
Switches			
Ignition (part of headlamp)	1960-62	54033027	63SA
ditto	1962	34287A	88SA
Knob	—	54332498	—
Lighting (part of headlamp)	1960-62	54033109	63SA
ditto	1962	34289A	88SA
Knob	—	54330934	—
Lighting and ignition (part of headlamp)	1958-59	31443E	PRS8
Knob	—	318346	—
Stop lamp	1958-62	31384B	22B
Spring, stop lamp	1958-62	315543	—

A.J.S. 500 c.c. o.h.v. '18CS', '18CT' and '18CS Southernner' (Competition Models) 1958-62

Alternator			
Rotor	1960-62	423506	RM15
Stator	1960-61	47122A	RM13
.. .. .	1962	47154A	RM15
Ammeter (part of headlamp) ..	1958-62	36084F	CZU27

continued



A.J.S. 500 c.c. o.h.v. '18CS', '18CT' and '18CS Southerner' (Competition Models) 1958-62 ⁶³

—continued

Unit	Year	Part No.	Model
Battery	1958-59	—	PUZ7E-11
	1960-62	—	MLZ9E
Cable harness	1958	838671	—
	1959	54941907	—
	1960-61	54945334	—
	1962	54949910	—
Control box	1958	37144A	MCR2
	1958	37144B	MCR2
	1959	37232H	RB108
Generator	1958-59	20038B	E3N
Horn	1958-59	*069446	HF1234
		(54068034)	
	1960-61	*70137A	HF1441
		(70048)	
	1962	70163A	8H
Horn push	1958-61	76204A	4A
Horn push and dip switch	1962	31563D	25SA
LAMPS			
Head			
Home and Export	1958	*50791D	MU42
		(51625)	
	1959	58224D	SSU700P
	1960-61	58586A	SS700P
	1962	58829A	SS700P
Stop tail and number plate	1958	53432B	564
ditto (U.S.A. only)	1958	53429A	529
ditto	1959-62	53429A/B	529
Magneto	1958-62	*42347D	NC1
		(42371)	
	1962-63	*42347E	NC1
		(42371)	
	(U.S.A. only)	42371A	NC1
Rectifier	1960-62	47132A/B	FSX1849
Reflex reflector	1960-62	57116A	RER25
Switches			
Dipper	1958-59	31482A	9
	1960-61	31620A	PS9
Lighting (part of headlamp)	1958	31340A	U39
	1959	*31754A/B	41SA
		(31763)	
	1960-61	31784A/D	41SA
	1962	34289A	88SA
Knob	1962	54330934	—
Stop lamp	1958-62	31384B	22B
Spring, stop lamp	—	315543	—

A.J.S. 500 c.c. o.h.v. Twin '20' 1958-61 600 c.c. o.h.v. Twin '30' 1958 and 650 c.c. o.h.v. Twin '31 Swift' 1959-62

Alternator	1959-62	423506	RM15
Rotor	1959-62	47122A	RM15
Stator	1962	47154A	RM15
(650 c.c., optional)	1958-62	36084F	CZU27
Ammeter (part of headlamp)	1958-59	—	PUZ7E-11
Battery	1960-61	—	MLZ9E
	1962	—	PUZ7E-11
Cable harness	1958	837351	—
(Sports, U.S.A. only)	1958	865136	—
	1959	54941756	—
	1960-62	54944147	—
	1962	54949914	—
(when optional equipment fitted)	1962	54949911	—
Coil, ignition	1959-62	45877B/E	MA6
Control box	1958	37252A	RB108
(Sports, U.S.A. only)	1958	37225E	RB108
Distributor	1959-62	40589D	18D2
Generator	1958	20035A	E3L
Horn	1958-61	*70137A	HF1441
		(70048)	
(Sports, U.S.A. only)	1958	*70136A	HF1441
		(70048)	
	1962	70163A	8H
Horn push and dip switch	1958-62	31563D	25SA
LAMPS			
Head			
Home and Export			
Dip left	1958	58177A	MCH57
	1958	58151A	MCH57
Vertical dip	1959	58354B	MCH57
	1960-62	58432A	MCH61
	1962	58702A	MCH61
Magneto ignition models	1962	58704A	MCH61
Export, vertical dip	1958	58178A	MCH57
ditto	1958	58152A	MCH57
ditto			
(Sports, U.S.A. only)	1958	*50791D	MU42
		(51628)	
ditto	1959	58354B	MCH57
ditto	1960-62	58432A	MCH61
Export Europe (not France)	1958	58179A	MCH57

A.J.S. 500 c.c. o.h.v. Twin '20' 1958-61 600 c.c. o.h.v. Twin '30' 1958 and 650 c.c. o.h.v. Twin '31 Swift' 1959-62 ⁶³

—continued

Unit	Year	Part No.	Model
LAMPS, Head—continued			
Export Europe (not France)			
ditto	1958	58153A	MCH57
ditto	1960-62	58516A	MCH61
ditto	1962	58832A	MCH61
Export France	1958	58180A	MCH57EF
	1958	58154A	MCH57EF
	1960-62	58517A	MCH61EF
	1962	58833A	MCH61EF
Stop tail and number plate	1958-62	53432B	564
Magneto	1958	42230D	K2F
(optional and Sports, U.S.A. only)	1958	*42264A	K2F
		(42380)	
	1962	*42264D	K2F
		(42380)	
Rectifier	1959	*47111A	FSW1501A
		(47132)	
	1959-62	47132A/B	FSX1849
Switches			
Cutout, magneto (when fitted)	1962	76204A/D	4A
Ignition (part of headlamp)	1960-62	54033056	63SA
ditto	1962	34287A	88SA
Knob	1960-62	54332498	—
Lighting (part of headlamp)	1958	31340A	U39
ditto	1958	*31754A	41SA
		(31763)	
ditto	1960-62	54033028	63SA
ditto	1962	34289A	88SA
Knob	—	54330934	—
Lighting and ignition (part of headlamp)	1959	*31460A	PR58
		(31443)	
Knob	—	318346	—
Stop lamp	1958-62	31384B	22B
Spring, stop lamp	1958-62	315543	—

A.J.S. 500 c.c. o.h.v. Twin '20 DeL' De Luxe 1959 and 650 c.c. o.h.v. Twin '31 DeL' De Luxe 1959-61

Ammeter	1959-61	36084F	CZU27
Battery	1959	—	PUZ7E-11
	1960-61	—	MLZ9E
Cable harness	1959	54942037	—
	1960-61	54944350	—
Control box	1959-61	37252A	RB108
	1961	37252B/D	RB108
Generator	1959-61	20035A	E3L
Horn	1959-61	*70137A	HF1441
		(70048)	
Horn push	1959	76204A	4A
Horn push and dip switch	1960-61	31563D	25SA
LAMPS			
Head			
Home and Export, vertical dip	1959	58152A	MCH57
ditto	1960-61	58477A	MCH61
Export Europe (not France)	1960-61	58518A	MCH61
Export France	1960-61	58519A	MCH61EF
Stop tail and number plate	1959-61	53432B	564
Magneto	1959-61	42230D	K2F
	1961	42230E	K2F
Switches			
Cutout, magneto	1959-61	76204A	4A
Dipper	1959-61	31482A	9
Lighting	1959	*31754A/B	41SA
		(31763)	
	1960-61	54033028	63SA
Knob	1960-61	54330934	—
Stop lamp	1959-61	31384B	22B
Spring, stop lamp	—	315543	—

A.J.S. 500 c.c. o.h.v. Twin '20CS' and '20CSR' 1959 and 650 c.c. o.h.v. Twin '31CS' and '31CSR Hurricane' 1959-62 (Competition Models)

Alternator	1962	423506	RM15
Rotor	1962	47154A	RM15
Stator	1959-62	36084F	CZU27
Ammeter (part of headlamp)	1962	36296A	2AR
(when fitted)	1959	—	PUZ7E-11
Battery	1960-61	—	MLZ9E
	1962	—	PUZ7E-11
Cable harness	1959	54941907	—
	1960-61	54945365	—
	1962	54949911	—
(31CSR and U.S.A. models)	1962	54949912	—

continued

* When ordering, quote part number shown in brackets



A.J.S. 500 c.c. o.h.v. Twin '20CS' and '20CSR' 1959 and 650 c.c. o.h.v. Twin '31CS' and '31CSR Hurricane' 1959-62 (Competition Models) —continued

Unit	Year	Part No.	Model
Control box	1959-61	37225E	RB108
" " " " Later	1961	37225F	RB108
Generator	1959-61	20035A	E3L
Horn	1959	*70136A (70048)	HF1441
" " " " " "	1960-61	*70137A (70048)	HF1441
" " " " " "	1962	70163A	8H
Horn push	1959-61	76204A	4A
Horn push and dip switch	1962	31563D	25SA
LAMPS			
Head			
Home and Export, vertical dip	1959-61	58224D	SSU700
ditto	1962	58829A	MCH61
ditto (650 c.c. 31CSR)	1962	58704A	MCH61
ditto (optional)	1962	58258B	F700P
Export (U.S.A., 650 c.c.)	1961-62	58556A	SS700P
Export Europe (not France) (650 c.c.)	1962	58830A	MCH61
Export France (650 c.c.)	1962	58831A	MCH61EF
Stop tail and number plate	1959-62	53429A/B	529
Magneto	1959	*42264A (42380)	K2F
" " " " " " Later	1959-61	*42264B (42380)	K2F
" " " " " " Later	1961-62	*42264D (42380)	K2F
Rectifier	1962	47132B	FSX1849
Switches			
Cutout, magneto	1959-62	76204A	4A
Dipper	1959-61	31482A	9
Lighting (part of headlamp)	1959-61	*31754A/B (31763)	41SA
" (650 c.c., U.S.A. only)	1962	31784D	41SA
" " " " " "	1962	34289A	88SA
Knob	1962	54330934	—
Stop lamp	1959-62	31384B	22B
Spring, stop lamp	—	315543	—

ARIEL 250 c.c. 'Leader' 1958-62

Alternator	1958-59	423506	RM13/15
Rotor	1958-59	46867B	RM13/15
Rotor	1960-61	423506	RM13/15
Rotor	1960-61	47137A	RM13/15
Rotor	1962	54213903	RM18
Rotor	1962	47161	RM18
Ammeter	1958-62	36084F	CZU27
Battery	1958-62	—	ML9E
Cable harness			
Models with flasher	1958-61	54940984	—
Models less flasher	1958-61	54941002	—
Cable harness	1962	54949615	—
Coil, ignition (2 off)	1958-62	45077B	MA6
Contact breaker	1958-62	*47580A/E (425379)	4CC
Flasher unit (optional)	1958-62	35013A	FL5
Horn	1958-62	*70146B (70142)	HF1849
" " " " " " Later	1962	70169A	8H
Horn push	1958	*76207A (76200)	HP26
" " " " " "	1959	76200B	HP26
" " " " " "	1960-62	*76234A (76200)	HP26
Inspection lamp sockets	1958-62	*39517B (301187)	—
LAMPS			
Flasher (optional)	1958-62	53733A/D	628
Head			
Home	1958-61	58204B	MCF575P
" " " " " "	1962	58897A	MCF575P
Export Europe (not France)	1958-61	58396A	MCF575P
" " " " " "	1962	58898A	MCF575P
Export France	1958-61	58397A	MCF575P
" " " " " "	1962	58899A	MCF575P
Stop tail and number plate	1958-62	53394B	564
Rectifier	1958-59	*47111A (47132)	FSW1501A
" " " " " "	1960-62	47132B	FSX1849
Switches			
Dipper	1958-62	*31549A (31482)	99
Flasher (optional)	1958-62	31823A	52SA
Ignition	1958-61	54033003	63SA
" " " " " "	1962	34427A	88SA

continued

ARIEL 250 c.c. 'Leader' 1958-62—continued

Unit	Year	Part No.	Model
Switches—continued			
Knob	1958	54330641	—
" " " " " "	1959-61	54330663	—
Cover	1962	54336307	—
Lighting	1958-61	54033004	63SA
" " " " " "	1962	34289A	88SA
Knob	1958	54330642	—
" " " " " "	1959-62	54330662	—
Neutral gear indicator (optional)	1958-62	31820A	68SA
Stop lamp (front brake)	1958	54033235	22B
" " " " " "	1959-62	31384B	22B
" " (rear brake)	1958-62	*31437B (54033234)	22B
Warning lights			
Flasher (optional)	1958	38188A	WL13
" " " " " "	1959-62	38193A	WL13
Neutral gear indicator	1958	38187A	WL13
" " " " " "	1959-62	38194A	WL13

ARIEL 250 c.c. 'Arrow' 1960-62 and 250 c.c. 'Super Sports Arrow' 1961-62

Alternator	1960-61	423506	RM13/15
Rotor	1960-61	47137A	RM13/15
Rotor	1962	54213903	RM18
Rotor	1962	47161	RM18
Stator	1960-62	36084F	CZU27
Ammeter (part of headlamp)	1960-62	—	ML9E
Battery	1960-62	—	—
Cable harness	1960	54945366	—
" " " " " "	1961	54947217	—
" " " " " "	1962	54946920	—
Coil, ignition (2 off)	1960-62	45077E	MA6
Contact breaker	1960-62	*47580E (425379)	4CC
Horn	1960	70157A	HF1849
" " " " " " Later	1960-61	70142D	HF1849
" " " " " "	1962	70163A	8H
" " " " " "	1962	70169A	8H
Horn push	1960	76200A	HP26
" " " " " " Later	1960-62	76234A	HP26
LAMPS			
Head			
Home	1960-61	58670A	MCH56
" " " " " "	1962	58892B	MCH56
Export Europe (not France)	1960-61	58672A	MCH56
" " " " " "	1962	58893B	MCH56
Export France	1960-61	58673A	MCH56
" " " " " "	1962	58896B	MCH56
Stop tail and number plate	1960-62	53394B	564
Rectifier	1960-62	47132B	FSX1849
Switches			
Dipper	1960-62	*31549A/B (31482)	99
Ignition (part of headlamp)	1960-61	54033003	63SA
" (Export France, part of headlamp)	1960-61	54033027	63SA
" (part of headlamp)	1962	34427	88SA
Knob	1960-61	54330663	—
Cover	1962	54336178	—
Lighting (part of headlamp)	1960-61	54033004	63SA
" (Export France, part of headlamp)	1960-61	54033028	63SA
" (part of headlamp)	1962	34289A	88SA
Knob	1960-61	54330662	—
" " " " " "	1962	54330934	—
Neutral gear indicator (optional)	1962	31820A	68SA
Stop lamp	1960-62	*31437B (54033234)	22B

ARIEL 350 c.c. o.h.v. 'NH' 'Red Hunter' and 500 c.c. o.h.v. 'VH' 'Red Hunter' 1958-59

Ammeter	1958-59	36084F	CZU27
Battery	1958	—	PUZ7E-9
" " " " " "	1959	—	PUZ7E-10
Cable harness	1958-59	838231	—
Control box	1958-59	37225E	RB108
Generator (part of magdyno)	1958-59	20034A	E3L
Horn	1958-59	*70136A (70048)	HF1441
Horn push and dip switch	1958-59	31563D	25SA
LAMPS			
Head			
Home	1958-59	51929A	MCH60
Export, vertical dip	1958-59	51930A	MCH60
Export Europe (not France)	1958-59	51931A	MCH60
Export France	1958	51820B	SS700PEF
" " " " " " Later	1958-59	51932A	MCH60EF

continued



ARIEL 350 c.c. o.h.v. 'NH' 'Red Hunter' and 500 c.c. o.h.v. 'VH' 'Red Hunter' 1958-59 —continued

Unit	Year	Part No.	Model
LAMPS—continued			
Stop tail and number plate	1958-59	53432B	564
Magdyno	1958-59	46051B	MOIL
Switches			
Lighting	1958-59	31340A	U39
Stop lamp	1958-59	*31437B (54033234)	22B
Spring, stop lamp	1958-59	315543	—

ARIEL 500 c.c. o.h.v. 'HS' 'Red Hunter' Scrambles 1958-59

Ammeter	1958-59	36084F	CZU27
Battery	1958	—	PUZ7E-9
	1959	—	PUZ7E-10
Cable harness	1958-59	838621	—
Horn	1958-59	*70136A (70048)	HF1441
Horn push and dip switch	1958-59	31563D	25SA
LAMPS			
Head (Home)	1958-59	51625	MU42
Stop tail and number plate	1958-59	53432B	564
Magneto	1958-59	42157K	KNR1
Switches			
Lighting	1958-59	31315A	U39

ARIEL 500 c.c. o.h.v. 'HS' Scrambles Mk. III and 600 c.c. s.v. 'VB' 1958

Ammeter	1958	36084F	CZU27
Battery	1958	—	PUZ7E-9
Cable harness (500 c.c.)	1958	838621	—
(600 c.c.)	1958	838231	—
Control box	1958	37225E	RB108
Generator (part of magdyno)	1958	20034A	E3L
Horn	1958	*70136A (70048)	HF1441
Horn push and dip switch	1958	31563D	25SA
LAMPS			
Head			
Home	1958	51929A	MCH60
Export, vertical dip	1958	51930A	MCH60
Export Europe (not France)	1958	51931A	MCH60
Export France	1958	51820B	SS700PEF
Later	1958	51932A	MCH60
Stop tail and number plate	1958	53432B	564
Magdyno	1958	46051B	MOIL
Switches			
Lighting	1958	31340A	U39
Knob	—	351567	—
Stop lamp	1958	*31437B (54033234)	22B
Spring, stop lamp	1958	315543	—

ARIEL 500 c.c. o.h.v. 'HTS' 'Red Hunter' Trials 1959

Ammeter	1959	36084F	CZU27
Battery	1959	—	PUZ7E-10
Cable harness	1959	838621	—
Control box	1959	37225E	RB108
Generator (part of magdyno)	1959	20034A	E3L
Horn	1959	*70136A (70048)	HF1441
Horn push and dip switch	1959	31563D	25SA
LAMPS			
Head			
Home	1959	51929A	MCH60
Export, vertical dip	1959	51930A	MCH60
Export Europe (not France)	1959	51931A	MCH60
Export France	1959	51932A	MCH60
Stop tail and number plate	1959	53432B	564
Magdyno	1959	46051B	MOIL
Switches			
Lighting	1959	31340A	U39
Stop lamp	1959	*31437B (54033234)	22B
Spring, stop lamp	—	315543	—

ARIEL 650 c.c. o.h.v. Twin 'FH' 'Huntmaster' 1958-59

Unit	Year	Part No.	Model
Ammeter	1958-59	36084F	CZU27
Auto-advance unit	1958-59	47503D	—
Battery	1958	—	PUZ7E-9
	1959	—	PUZ7E-10
Cable harness	1958-59	838231	—
Control box	1958-59	37225E	RB108
Generator	1958-59	20010K	E3L
Horn	1958-59	*70136A (70048)	HF1441
Horn push and dip switch	1958-59	31563D	25SA
LAMPS			
Head			
Home	1958-59	51929A	MCH60
Export, vertical dip	1958-59	51930A	MCH60
Export Europe (not France)	1958-59	51931A	MCH60
Export France	1958	51820B	SS700PEF
Later	1958-59	51932A	MCH60EF
Stop tail and number plate	1958-59	53432B	564
Magneto	1958-59	42248E	K2F
Switches			
Cutout, magneto	1958-59	76200B	HP26
Lighting	1958-59	31340A	U39
Knob	—	351567	—
Stop lamp	1958-59	*31437B (54033234)	22B
Spring, stop lamp	—	317577	—

ARIEL 1,000 c.c. '4G' 'Square Four' 1958-59

Ammeter	1958-59	*36220A (36184)	CZU27
Battery	1958-59	—	GUZ11E
Cable harness	1958-59	838361	—
Coil, ignition	1958-59	45077B	MA6
Control box	1958-59	37225E	RB108
Distributor	1958-59	*40486A (40426)	DKX4A
Generator	1958-59	22011A	C35SD
Horn	1958-59	*069239 (54068034)	HF1234
Horn push and dip switch	1958-59	31563D	25SA
LAMPS			
Head			
Home	1958-59	51929A	MCH60
Export, vertical dip	1958-59	51930A	MCH60
Export Europe (not France)	1958-59	51931A	MCH60
Export France	1958	51820A	SS700PEF
Later	1958-59	51932A	MCH60EF
Stop tail and number plate	1958-59	53432B	564
Switches			
Ignition	1958-59	31083E	S53
Lighting	1958-59	31340A	U39
Knob	—	351567	—
Stop lamp	1958-59	*31437B (54033234)	22B
Spring, stop lamp	—	317577	—

B.S.A. 70 c.c. 'Dandy' 1958-59

Cable harness	1958-59	863745	—
Horn	1958-59	70145A/D	HF1950
Horn push	1958-59	76204A	4A
LAMPS			
Head	1958-59	58198B	MCH62
Tail and number plate	1958-59	53555A	590
Magneto			
Flywheel	1958-59	54441000	8F1
Stator	—	42372	—
Suppressor	1958-59	+78106A	WS5
Switches			
Dipper (part of headlamp)	1958-59	31620B/E	PS9
Lighting	1958-59	31777A	61SA

B.S.A. 125 c.c. D1 'Bantam' 1958-62

150 c.c. D3 'Bantam Major' 1958

175 c.c. D5 'Bantam Super' 1958

175 c.c. D7 'Bantam Super' 1959-62

Battery	1958-62	—	PUZ5E-11
Suppressor	1958-60	78106A	WS5

* When ordering, quote part number shown in brackets



B.S.A. 175 c.c. 'Sunbeam' Scooter (B1) 1959-62

Unit	Year	Part No.	Model
Battery	1959-62	—	MLZ9E
Horn	1959	*70153E (70155)	5H
.. .. .	1960-62	70155A	5H
.. .. .	1962	70169A	8H
Suppressor	1959-62	78106A	WS5

B.S.A. 250 c.c. 'Sunbeam' Scooter (B2, 6 volt) 1959-62

Alternator			
Rotor	1959-62	54210940	5AF
Stator	1959-62	47136A	5AF
Rotor	1962	54214031	9AF
Stator	1962	47174	9AF
Battery	1959-62	—	MLZ9E
Cable harness	1959-61	54941657	—
.. .. .	1962	54949612	—
Coil, ignition	1959-62	45077B/E	MA6
Contact breaker	1959-62	47583A/B	4CA
Horn	1959	*70153A	5H
.. .. .	1960-62	70155A	5H
.. .. .	1962	70169A	9H
Horn push and dip switch	1959-62	31563D	25SA
LAMPS			
Head			
Home	1959	51519B	MCF575
.. .. .	1959-62	58417A/D	MCF575P
Export Europe (not France)	1959-62	58418A/D	MCF575P
Export France	1959-62	58419A/D	MCF575PEF
Export U.S.A.	1959-62	58420A/B	MCF575
Stop tail and number plate	1959-62	53432B	564
Rectifier	1959	*47111A (47132)	FSW1501
.. .. .	1960-62	47132B	FSX1849
Suppressor	1960-62	78106A	WS5
Switches			
Ignition	1959-61	54033027	63SA
.. .. .	1962	34427A	88SA
Knob	1959-61	54331351	—
Cover	1962	54336178	—
Lighting	1959-61	54033028	63SA
.. .. .	1962	34289A	88SA
Knob	1959-62	54331482	—
Stop lamp	1959-62	*31437B (54033234)	22B
Warning light	1959-62	38198A/E	WL13

B.S.A. 250 c.c. 'Sunbeam' Scooter (B25, 12 volt, electric starting) 1959-62

Alternator			
Rotor	1959-62	54210946	5AF
Stator	1959-62	47135A	5AF
Battery (2 off)	1959-62	—	MLZ9E
Cable harness	1959-61	54941657	—
.. .. .	1962	54949612	—
Coil, ignition	1959-62	45101A	MA12
Contact breaker	1959-62	47583A/B	4CA
Horn	1959	*70152A (70156)	5H
.. .. .	1960-62	70156A	5H
.. .. .	1962	70164A	8H
Horn push and dip switch	1959-62	31563D	25SA
LAMPS			
Head			
Home	1959	58382A	MCF575
.. .. .	1959-62	58421A/D	MCF575P
Export Europe (not France)	1959-62	58422A/D	MCF575P
Export France	1959-62	58423A/D	MCF575PEF
Export U.S.A.	1959-62	58424A/B	MCF575
Stop tail and number plate	1959-62	53454B	564
Rectifier	1959-62	47128A/B	FSX1850
Starting motor	1959-62	26501A/E	M3
Suppressor	1959-62	78106A	WS5
Switches			
Ignition	1959-61	54033027	63SA
.. .. .	1962	34427A	88SA
Knob	1959-61	54331351	—
Cover	1962	54336178	—
Lighting	1959-61	54033028	63SA
.. .. .	1962	34289A	88SA
Knob	1959-62	54331482	—
Starting motor	1959-62	*76463A (76442)	4SA
Stop lamp	1959-62	*31437B (54033234)	22B
Warning light	1959-62	*38197A/E (38118)	WL13

B.S.A. 250 c.c. 'C12' 1958

Unit	Year	Part No.	Model
Alternator			
Rotor	1958	423306	RM13/15
Stator	1958	468678	RM13/15
Ammeter (part of headlamp)	1958	36084F	CZU27
Battery	1958	—	PUZ7E-10
Cable harness	1958	863125	—
Coil, ignition	1958	45077B	MA6
Contact breaker	1958	*47568D (47572)	CA1A
Horn	1958	*069508 (54068036)	HF1235
Horn push	1958	*76207A (76200)	HP26
Grommet	—	572039	—
LAMPS			
Head			
Home and Export, dip left	1958	51890A	MCH52
Export, vertical dip	1958	51845B	MCH52
Maroon body	1958	58147A	MCH52
Black body	1958	51846A	MCH52
Export Europe (not France)	1958	51847A/B	MCH52EF
Export France	1958	53432B	564
Stop tail and number plate	1958	*47111A (47132)	FSW1501A
Rectifier	1958	78106A	WS5
Suppressor	1958	—	—
Switches			
Dipper	1958	*31549A (31482)	99
Lighting and ignition	1958	31443E	PRS8
Knob	—	318346	—
Stop lamp	1958	*31437B (54033234)	22B
Spring, stop lamp	—	315543	—

B.S.A. 250 c.c. 'C15 Star' 1959-62 and 250 c.c. 'SS80 Sports Star' 1961-62

Alternator			
Rotor	1959-61	466125	RM13
Stator	1959-61	47134A	RM13
Rotor	1962	54213903	RM18
Stator	1962	47161A	RM18
Ammeter (part of headlamp)	1959-62	36084F	CZU27
Battery	1959-62	—	MLZ9E
Cable harness	1959-61	54940666	—
.. .. .	1962	54949610	—
Coil, ignition	1959-62	45077B/E	MA6
Distributor	1959-60	*40621B (40701)	15D1
Horn	1961-62	40701A	15D1
.. .. .	1959-61	*70146B (70142)	HF1849
Horn push and dip switch	1962	70169A	8H
LAMPS			
Head			
Home and Export, vertical dip	1959-62	58234D	MCF575P
Export Europe (not France)	1959-62	58392A	MCF575P
Export France	1959-62	58391A	MCF575PEF
Export U.S.A.	1959-62	53394B	564
Stop tail and number plate	1959-62	*47111A (47132)	FSW1501A
Rectifier	1959	47132B	FSX1849
Switches			
Ignition	1959-61	54033003	63SA
.. .. .	1962	34427A	88SA
Escutcheon plate	1959-61	54330576	—
Cover	1962	54336178	—
Knob	1959-61	54331351	—
Lighting	1959-61	54033004	63SA
.. .. .	1962	34289A	88SA
Escutcheon plate	1959-62	54330576	—
Knob	1959-62	54330934	—
Stop lamp	1959-62	31827A	6SA
Cover, rubber	1959-60	360363	—

B.S.A. 250 c.c. 'C15T' Trials 1959-62 and 250 c.c. 'C15S' Scrambles 1959-62

Alternator			
Rotor	1959-61	466125	RM13
Stator	1959	*47138 (47175)	RM13
.. .. .	1960-61	*47141A (47176)	RM13
.. .. . (models with stop light)	1960-61	*47143A (47177)	RM13

continued

* When ordering, quote part number shown in brackets



B.S.A. 250 c.c. 'C15T' Trials 1959-62 250 c.c. 'C15S' Scrambles 1959-62—continued

Unit	Year	Part No.	Model
<i>Alternator—continued</i>			
Rotor	1962	54213901	RM19
Stator	1962	47173A/B	RM19
Ammeter	1960-62	36084F	CZU27
Cable harness	1959-62	54094099	—
Coil, ignition	1959-62	45112A/D	2ET
Distributor	1959-60	*40669A/B (40702)	15D1
.. .. . Later	1960-62	40702A	15D1
Horn (when fitted)	1959-62	70145A/D	HF1950
Horn push	1959-62	76204D	4A
LAMPS			
<i>Head</i>			
Home and Export, vertical dip	1959-62	58395B/E	MCH66
Stop tail and number plate	1960	53394B	564
.. .. .	1961-62	53432B	564
Tail and number plate	1959-61	53825A	564
<i>Switches</i>			
Cutout	1959-62	76204D	4A
Dipper (part of headlamp)	1959-62	31620A/E	PS9
Lighting (part of headlamp)	1959-62	*31276A/B (31356)	PS6
Stop lamp	1960-62	31827A	6SA

B.S.A. 350 c.c. 'B31' 1958-59 and 500 c.c. 'B33' 1958-60

Alternator	1958-60	423506	RM15
Rotor	1958-60	469427	RM15
Stator	1958-60	36084F	CZU27
Ammeter	1958-60	—	PUZ7E-10
Battery	1958-60	865258	—
Cable harness	1958-60	45077B/E	MA6
Coil, ignition	1958-60	40599A	18D1
Distributor	1958-60	70137A	HF1441
Horn	1958-59	31563D	25SA
Horn push and dip switch	1958-59	31563D	25SA
LAMPS			
<i>Head</i>			
Home and Export, dip left	1958-60	58158A/B	MCF700P
Export, vertical dip	1958-60	58159A/B	MCF700P
Export Europe (not France)	1958-60	58160A/B	MCF700P
Export France	1958-60	58161A/B	MCF700PEF
Stop tail and number plate	1958-60	53432B	564
Rectifier	1958	*47111A (47132)	FSW1501A
.. .. .	1959-60	47132	—
Suppressor	1958-60	78106A	WS5
<i>Switches</i>			
Lighting and ignition	1958-60	31443A	PRS8
Knob	—	318346	—
Stop lamp	1958-59	*31437B (54033234)	22B
.. .. .	1960	34257A	6SA
"Spring, stop lamp"	1958-59	317577	—

B.S.A. 350 c.c. o.h.v. 'B32' and 500 c.c. o.h.v. 'B34' 'Gold Star' and Competition 1958-62

Ammeter (part of headlamp)	1958-61	36084F	CZU27
.. .. .	1962	36296A	2AR
Battery	1958-62	—	PUZ7E-10
Cable harness	1958-62	865493	—
.. .. . Later	1962	54949331	—
.. .. . (Competition)	1958-59	837771	—
Control box	1958-60	37225E/J	RB108
.. .. .	1961-62	37221K	RB108
Generator (part of magdyno)	1958-62	20034B	E3L
Horn	1958-61	*069483 (54068034)	HF1234
.. .. .	1962	70163	8H
.. .. . Later	1962	70169	8H
Horn push (Competition only)	1958	76204A	4A
.. .. . ('Clubman')	1959-62	76204A/D	4A
.. .. .	1962	76206E	4A
Horn push and dip switch	1958	31563D	25SA
LAMPS			
<i>Head</i>			
Home and Export, dip left	1958-59	51854A	SSU700P
ditto Later	1959-62	58210B/D	SSU700P
Export, vertical dip	1958-59	*51686D (51829)	SSU700P
.. .. . Later	1959-61	58224B/D	SSU700P
.. .. .	1962	58859	SSU700P
Export Europe (not France)	1958-59	*51788A (51832)	SSU700P
ditto Later	1959-62	*58209B/D (58224)	SSU700P

B.S.A. 350 c.c. o.h.v. 'B32' and 500 c.c. o.h.v. 'B34' 'Gold Star' and Competition 1958-62—continued

Unit	Year	Part No.	Model
<i>LAMPS, Head—continued</i>			
Export France	1958-59	51632A	SSU700PEF
.. .. . Later	1959-62	58211B/D	SSU700PEF
Export U.S.A.	1958	58208B	SSU700P
.. .. .	1959-62	58224	SSU700P
Stop tail and number plate	1958-62	53432B	564
Magneto (Competition)	1958-62	42348D/E	KNC1
.. .. . (Racing)	1958-62	42123M	KNR1
Magdyno	1958-62	46048A	MO1L
Suppressor	1958-62	78106A	WS5
<i>Switches</i>			
Dipper (Competition only)	1958	*31549A (31482)	99
.. .. .	1959-62	*31549B (31482)	99
Lighting (part of headlamp)	1958-59	31340A	U39
ditto Later	1959-62	*31754A (31763)	41SA
Stop lamp	1958-60	*31437B (54033234)	22B
.. .. .	1961-62	34257A	6SA
"Spring, stop lamp"	1958-60	317577	—

B.S.A. 350 c.c. 'B40 Star' 1961-62

Alternator	1961-62	423506	RM13/15
Rotor	1961-62	47134	RM13/15
Stator	1962	54213903	RM18
Rotor Later	1962	47161	RM18
Stator Later	1961-62	36084F	CZU27
Ammeter	1961-62	—	MLZ9E
Battery	1961	54940566	—
Cable harness	1962	54949610	—
Coil, ignition	1961-62	45077E	MA6
Distributor	1961-62	40701A	15D1
Horn	1961	70146B	HF1849
.. .. .	1962	70163A	8H
.. .. . Later	1962	70169A	8H
LAMPS			
<i>Head</i>			
Home and Export, vertical dip	1961-62	58334D	MCF575P
Export Europe (not France)	1961-62	58392A	MCF575P
Export France	1961-62	58391A	MCF575PEF
Stop tail and number plate	1961-62	53432B	564
Rectifier	1961-62	47132B	FSX1849
<i>Switches</i>			
Ignition	1961	54033003	63SA
Knob	—	54331351	—
Escutcheon plate	—	54330576	—
Ignition	1962	34427A	88SA
Cover	—	54336178	—
Lighting	1961	54033004	63SA
Knob	—	54330934	—
Escutcheon plate	—	54330486	—
Lighting	1962	34289A	88SA
Knob	—	54330334	—
Escutcheon plate	—	54330485	—
Stop lamp	1961-62	31827A	6SA

B.S.A. 500 c.c. 'M20' 1958-62 and 600 c.c. 'M21' 1958-62

Ammeter (part of headlamp)	1958-62	36084F	CZU27
Battery	1958-62	—	PUZ7E-10
Cable harness	1958-62	839850	—
Control box	1958-59	37225E	RB108
.. .. .	1960-62	37225H/J	RB108
Generator (part of magdyno)	1958-62	20034A	E3L
Horn (Rigid frame)	1958-60	*069468 (54068034)	HF1234
Horn (Spring frame)	1958-62	*069483 (54068034)	HF1234
Horn push and dip switch	1958-60	31563A/D	25SA
LAMPS			
<i>Head</i>			
Home and Export, dip left	1958-62	58169A	SSU700P
Export, vertical dip	1958-62	58170A	SSU700P
Export Europe (not France)	1958-62	58171A	SSU700P
Export France	1958-62	58172A	SSU700PEF
Sidecar (when fitted)	1958-60	52268D	569
Stop tail and number plate	1958-62	53432B	564
Magdyno	1958-62	46048A	MO1L
Suppressor	1958-59	78106A	WS5

* When ordering, quote part number shown in brackets



B.S.A. 500 c.c. 'M20' 1958-62 and 600 c.c. 'M21' 1958-62—continued

Unit	Year	Part No.	Model
Switches			
Lighting (part of headlamp)	1958-62	*31754A (31763)	41SA
Stop lamp	1958-62	31281B	54C
Spring, stop lamp	1958-62	317577	—

B.S.A. 500 c.c. 'A50 Star Twin' and 650 c.c. 'A65 Star Twin' 1962

Alternator			
Rotor	1962	54213901	RM19
Stator (54021023)	1962	47164	RM19
Ammeter	1962	36296A	2AR
Battery	1962	—	MLZ9E
Cable harness	1962	54949736	—
Coil, ignition	1962	45077E	MA6
Contact breaker	1962	47583A/B	4CA
Horn	1962	70169A	8H
LAMPS			
Head			
Home and Export, dip left	1962	58158B	MCF700P
Export, vertical dip	1962	58159B	MCF700P
Export Europe (not France)	1962	58160B	MCF700P
Export France	1962	58161B	MCF700PEF
Stop tail and number plate	1962	53432B	564
Rectifier	1962	47132B	FSX1849
Switches			
Ignition	1962	34427A	88SA
Cover	—	54336178	—
Lighting	1962	34289A	88SA
Knob	—	54330934	—
Escutcheon plate	—	54330485	—
Stop lamp	1962	34448A	6SA

B.S.A. 500 c.c. o.h.v. 'A7' and 'A7 Shooting Star' and 650 c.c. 'A10 Golden Flash' 1958-62

Ammeter	1958-62	36084F	CZU27
Auto advance unit	1958-62	47503B/E	—
Battery	1958-60	—	PUZ7E-10
	1961-62	—	MLZ9E
Cable harness	1958	839770	—
	1959-62	839780	—
Control box	1958-60	37225E/J	RB108
	1961-62	37221K	RB108
Generator	1958-62	20036A	E3L
Horn	1958-62	70137A	HF1441
	Later	70169A	8H
Horn push and dip switch	1958-59	31563A	25SA
LAMPS			
Head			
Home and Export, dip left	1958-62	58158A/B	MCF700P
Export, vertical dip	1958-62	58159A/B	MCF700P
Export Europe (not France)	1958-62	58160A/B	MCF700P
Export France	1958-62	58161A/B	MCF700PEF
Export U.S.A.	1962	58208D	SSU700P
Stop tail and number plate	1958-62	53432B	564
Magneto	1958	*42248E (42379)	K2F
	1959-62	42379A/B	K2F
" ('Shooting Star')	1958	*42263D (42380)	K2F
	1959-60	42380A/B	K2F
	1961-62	42413A	K2F
Switches			
Cutout, magneto	1958-61	76204A	4A
Lighting	1958-62	*31754A (31763)	41SA
Escutcheon plate	1961-62	J51803	—
Stop lamp	1958-59	*31437B (54033234)	22B
Spring, stop lamp	—	315543	—
Stop lamp	1960-62	34257A	6SA

B.S.A. 650 c.c. 'A10 Road Rocket' 1958 and 'Super Rocket' 1959-62

Ammeter	1958-62	36084F	CZU27
Battery	1958-60	—	PUZ7E-10
	1961-62	—	MLZ9E
Cable harness—Home	1958	839770	—
" " — Later	1958-61	839780	—
" " — U.S.A.	1962	54949773	—
" " — except U.S.A.	1958-62	865494	—
ditto (alternative)	1958-59	865493	—
Control box	1958-60	37225E/H	RB108
	1961-62	37221K	RB108

continued

B.S.A. 650 c.c. 'A10 Road Rocket' 1958 and 'Super Rocket' 1959-62—continued

Unit	Year	Part No.	Model
Generator	1958-62	20036A	E3L
Horn	1958-60	*069482 (54068034)	HF1234
"	1961-62	70137A	HF1441
"	1962	70169A	8H
" (U.S.A. only)	1961-62	*069482 (54068034)	HF1234
Horn push and dip switch	1958	31563D	25SA
LAMPS			
Head			
Home and Export, dip left	1958-62	58158A/B	MCF700P
Export, vertical dip	1958-59	*51686D (51829)	SSU700P
	Later	58224B	SSU700P
Export Europe (not France)	1958-59	*51788A (51832)	SSU700P
ditto	Later	*58209B (58224)	SSU700P
Export France	1958-59	51632A	SSU700PEF
	Later	58211B	SSU700PEF
Export U.S.A.	1958-62	58208B	SSU700P
Stop tail and number plate	1958-62	53432B	564
Magneto	1958	*42263D (42413)	K2F
"	1959-60	42380A	K2F
"	1961-62	42413A	K2F
Switches			
Cutout, magneto	1958-61	76204A	4A
Lighting	1958-59	31340A	U39
	1959-62	*31754A/B (31763)	41SA
Stop lamp	1958-59	*31437B (54033234)	22B
Spring, stop lamp	—	315543	—
Stop lamp	1960-62	34257A	6SA

B.S.A. 650 c.c. 'Rocket Gold Star Twin' 1962

Ammeter	1962	36084F	CZU27
Battery	1962	—	MLZ9E
Cable harness	1962	865494	—
Control box	1962	37221K	RB108
Generator	1962	20036A	E3L
Horn	1962	*069482 (54068034)	HF1234
LAMPS			
Head			
Home and Export, vertical dip	1962	58208D	SSU700P
Stop tail and number plate	1962	53432B	564
Magneto	1962	42413A	K2F
Switches			
Cutout, magneto	1962	76204D	4A
Lighting	1962	*31754B (31763)	41SA
Stop lamp	1962	*31437B (54033234)	22B

DOUGLAS 'Vespa' 1958-62

Battery	1958-60	—	PUZ5E-13
	1961-62	—	MKZ5E
Cable harness	1958-59	54943527	—
"	1960	54946189	—
" 125 c.c.	1961-62	54948006	—
" 150 c.c.	1961	54948007	—
" 150 c.c.	1962	54931371	—
LAMPS			
Sidcar	1958-60	52233B	516
Tail and number plate	1958-60	53324A	544
Reflex reflector	1958-60	57110A	RER5

ENFIELD 148 c.c. 'Ensign' 1959 and 148 c.c. 'Prince' 1959-62

Horn	1959-60	70145D	HF1950
"	1961-62	70142D	HF1849

ENFIELD 250 c.c. o.h.v. 'Clipper' 1958-62

Alternator			
Rotor	1958	466233	RM13
Stator	1958	468678	RM13
Rotor (from engine No. 1301)	1958-61	466125	RM13
Stator (frame No. 10270)	1958-61	468678	RM13
Rotor	1962	54213903	RM18
Stator	1962	47161A	RM18

continued

* When ordering, quote part number shown in brackets



ENFIELD 250 c.c. o.h.v. 'Clipper' 1958-62

—continued

Unit	Year	Part No.	Model
Ammeter	1958-62	36084F	CZU17
Battery	1958-59	—	PUZ5E-11
	1959-61	—	PUZ7E-11
	1962	—	PUZ5E-11
Cable harness	1958	838291	—
ditto (from Engine No. 1301, Frame No. 10270)	1958-62	838681	—
Cable harness (Airflow)	1962	54930058	—
	1960-62	839870	—
	1962	54930095	—
Coil, ignition	1958-62	45077B/E	MA6
Contact breaker (from Engine No. 1301, Frame No. 10270)	1958-62	47571A/E	CA1A
Distributor (up to Engine No. 1300)	1958	*40466B (40712)	15D1
Horn (from Engine No. 1301, Frame No. 10270)	1958-62	70142B/D	HF1849
Horn	1962	70163A	8H
Horn push and dip switch	1958-62	31563D	25SA
LAMPS			
Head			
Home and Export, vertical dip	1958	*51750B (51519)	MCF575P
Home, dip left (from Engine No. 1301, Frame No. 10270)	1958	51856A	MCF700
Home and Export, vertical dip	1959-62	50943E	MCF700
ditto (Airflow)	1959-62	58258A/B	F700P
Export, vertical dip (from Engine No. 1301, Frame No. 10270)	1958	50943E	MCF700
Export Europe (not France) (from Engine No. 1301, Frame No. 10270)	1958-62	51112D	MCF700
Export France (from Engine No. 1301, Frame No. 10270)	1958-62	51134D	MCF700EF
Pilot (from Engine No. 1301, Frame No. 10270)	1958-62	52234A	550
Stop tail, number plate and reflex (from Engine No. 1301, Frame No. 10270)	1958-62	53394B	564
	1958	53256A	529
Tail and number plate	1958-59	*47111A (47132)	FSW1501A
Rectifier	1960-62	47132B	FSX1849
	1958	*57048A (57131)	RER5
Reflex reflector			
Switches			
Ignition	1958-62	34093B	PRI-2
	1962	34427A	88SA
Lighting	1958-62	*31491A (31684)	U39
	1962	34289A	88SA
(Airflow)	1960-62	31784A	41SA
Knob	1962	54330934	—
Stop lamp (when fitted)	1958-60	*31437B/D (54033234)	22B
	1961-62	31688A	6SA
Spring, stop lamp (when fitted)	1958-60	315774	—

ENFIELD 250 c.c. o.h.v. 'Crusader' 1958-62, 'Crusader' Sports 1959-62 and 'Super Sports 5' 1962

Alternator	1958-61	466125	RM13
Rotor	1958-61	468678	RM13
Stator	1962	54213903	RM18
Rotor	1962	47161A	RM18
Stator	1958-62	36084F	CZU27
Ammeter	1958-59	—	PUZ5E-11
Battery	1959-61	—	PUZ7E-11
(Airflow)	1958-61	—	PUZ7E-11
(Sports)	1961-62	—	PUZ5E-11
Cable harness	1958-62	838681	—
	1962	54930058	—
(Airflow)	1958	839870	—
	1959	54940814	—
	1960-62	839870	—
	1962	54930095	—
Coil, ignition	1958-62	45077B/E	MA6
Contact breaker	1958-62	47571A/E	CA1A
Horn	1958-61	70142B/D	HF1849
	1962	70163A	8H
Horn push (Sports)	1961-62	76204D	4A
Horn push and dip switch	1958-62	31563D	25SA
LAMPS			
Head			
Home and Export, dip left	1958	51856A	MCF700
Home and Export, vertical dip	1959-62	50943E	MCF700

continued

ENFIELD 250 c.c. o.h.v. 'Crusader' 1958-62, 'Crusader' Sports 1959-62 and 'Super Sports 5' 1962—continued

Unit	Year	Part No.	Model
LAMPS, Head—continued			
Home and Export, vertical dip (Airflow)	1958-62	58258A/B	F700P
ditto (Super Sports)	1962	51756E	MCF700P
Export, vertical dip	1958	50943E	MCF700
Export Europe (not France)	1958-62	51112D	MCF700
Export France	1958-62	51134D	MCF700EF
Pilot	1958-62	52234A	550
Stop tail, number plate and reflex	1958-62	53394B	564
Rectifier	1958-59	*47111A (47132)	FSW1501A
	1960-62	47132B	FSX1849
Switches			
Dipper (Sports)	1960-62	*31549B (31482)	99
Ignition	1958-61	34093B	PRI-2
	1962	34427A	88SA
Lighting	1958-61	*31491A (31684)	U39
	1962	34289A	88SA
(Airflow)	1958-62	31784A	41SA
Knob	1962	54330934	—
Stop lamp (when fitted)	1958-60	*31437B/D (54033234)	22B
	1960-62	31688A	6SA
Spring, stop lamp (when fitted)	1958-60	315774	—

ENFIELD 350 c.c. 'Madras G2' (CKD Model built in India) 1958-62

Alternator	1959	466230	RM14
Rotor	1959	468677	RM14
Stator	1959-61	423506	RM15
Rotor	1959-61	469427	RM15
Stator	1962	54213901	RM19
Rotor	1962	47164	RM19
Stator	1958-62	36084F	CZU27
Ammeter	1959	47556B	—
Auto advance unit	1960-62	47556B	—
ditto (Special orders)	1958-61	—	PUZ7E-11
Battery	1962	—	MLZ9E
Cable harness	1958	837541	—
	1959	838481	—
	1960-62	839870	—
	1962	54930095	—
Coil, ignition	1960-62	45077E	MA6
Control box	1958	37225E	RBI08
Distributor	1960	*40466B (40712)	15D1
Generator	1961-62	40712A	15D1
Horn	1958	20034A	E3L
	1958	*069239	HF1234
	1959-61	(54068034)	HF1234
	1962	*069424 (54068034)	8H
Horn push	1958	70163A	8H
	1958	*76209A (76200)	HP26
Horn push and dip switch	1959-62	31563D	25SA
LAMPS			
Head			
Export, vertical dip	1958-62	50943E	MCF700
ditto (Airflow)	1959-62	58258A	F700
Pilot	1958-62	52234A	550
Stop tail, number plate and reflex	1958-62	53432B	564
Magneto	1959	*42210B (42281)	SR1
(Special orders)	1960-61	*42230B (42281)	SR1
	1962	*42230D (42281)	SR1
Magneto	1958	46049A	MO1L
Rectifier	1959	*47111A (47132)	FSW1501A
	1960-62	47132B	FSX1849
Switches			
Cutout, magneto (when fitted)	1961-62	76204D	4A
Dipper	1958	*31549A (31482)	99
Ignition	1960-61	34093B	PRI-2
	1962	34427A	88SA
Lighting	1958	31340A	U39
	1959-61	*31491A (31684)	U39
	1962	34289A	88SA
(Airflow)	1959-62	31784A	41SA
Knob	1962	54330934	—
Stop lamp (when fitted)	1958-62	*31437B/D (54033234)	22B
Spring, stop lamp	1958-62	315774	—

* When ordering, quote part number shown in brackets



ENFIELD 350 c.c. o.h.v. 'Bullet' 1958-62

Unit	Year	Part No.	Model
Alternator	1958-59	466230	RM14
Rotor	1958-59	468677	RM14
Stator	1959-61	423506	RM15
Rotor Later	1959-61	469427	RM15
Stator Later	1962	54213901	RM19
Rotor	1962	47164A	RM19
Stator	1958-62	36084F	CZU27
Ammeter	1958-59	47556B	—
Auto advance unit	1960-62	47556B	—
ditto (Special orders)	1958-61	—	PUZ7E-11
Battery	1958-59	838481	—
Cable harness	1960-62	839870	—
" Later	1962	54930095	—
Coil, ignition	1960-62	45077E	MA6
Distributor	1960	*40466B (40712)	15D1
"	1961-62	40712A	15D1
Horn	1958	*069239 (54068034)	HF1234
"	1959-61	*069424 (54068034)	HF1234
"	1962	70163A	8H
Horn push	1962	76204D	4A
Horn push and dip switch	1958-61	31563D	25SA
ditto (Airflow)	1962	31563D	25SA
LAMPS			
Head			
Home and Export, dip left	1958	51856A	MCF700
ditto, vertical dip	1959-62	50943E	MCF700
ditto (Airflow)	1959-62	58258A	F700
Export, vertical dip	1958	50943E	MCF700
Export Europe (not France)	1958-62	51112D	MCF700
Export France	1958-62	51134D	MCF700EF
Pilot	1958-62	52234A	550
Stop tail, number plate and reflex	1958-62	53432B	564
Magneto	1958-59	*42330B (42281)	SR1
" (Special orders)	1960-61	*42330B (42281)	SR1
"	1962	*42330D (42281)	SR1
Rectifier	1958-59	*47111A (47132)	FSW1501A
"	1960-62	47132B	FSX1849
Switches			
Cutout, magneto (when fitted)	1961-62	76204D	4A
Dipper	1962	*31549B (31482)	99
Ignition	1960-61	34093B	PR1-2
"	1962	34427A	88SA
Lighting	1958-61	*31491A (31684)	U39
"	1962	34289A	88SA
" (Airflow)	1959-62	31784A	4ISA
Knob	1962	54330934	—
Stop lamp (when fitted)	1958-60	31437D (54033234)	22B
" Later	1960-62	31688A	6SA
Spring, stop lamp	1958-60	315774	—

ENFIELD 350 c.c. o.h.v. 'Clipper' 1958-62

Unit	Year	Part No.	Model
Alternator	1958-59	466230	RM14
Rotor	1958-59	468677	RM14
Stator	1959-61	423506	RM15
Rotor Later	1959-61	469427	RM15
Stator Later	1962	54213901	RM19
Rotor	1962	47164A	RM19
Stator	1958-62	36084F	CZU27
Ammeter	1958-59	47556B	—
Auto advance unit (U.S.A. and special orders)	1961-62	47556B	—
Battery	1958-61	—	PUZ7E-11
"	1962	—	MLZ9E
Cable harness	1958-62	839870	—
" Later	1962	54930095	—
Coil, ignition	1958-62	45077B/E	MA6
Distributor	1958-60	*40466B (40712)	15D1
"	1960-62	40712A	15D1
Horn	1958-61	*069424 (54068034)	HF1234
"	1962	70163A	8H
Horn push and dip switch	1958-62	31563D	25SA
LAMPS			
Head			
Home and Export, dip left	1958	51856A	MCF700
Home and Export, vertical dip	1959-62	50943E	MCF700
ditto (Airflow)	1959-62	58258A/B	F700
Export, vertical dip	1958	50943E	MCF700
Export Europe (not France)	1958-62	51112D	MCF700
Export France	1958-62	51134D	MCF700EF
Pilot	1958-62	52234A	550
Stop tail, number plate and reflex	1958-62	53432B	564
Magneto	1958-59	*42330B (42281)	SR1
" (special orders)	1960-61	*42330B (42281)	SR1
"	1962	*42330D (42281)	SR1
Rectifier	1958-59	*47111A (47132)	FSW1501A
"	1960-62	47132B	FSX1849
Switches			
Cutout, magneto (when fitted)	1961-62	76204D	4A
Dipper	1962	*31549B (31482)	99
Ignition	1960-62	34093B	PR1-2
Lighting	1958-62	*31491A (31684)	U39
" (Airflow)	1959-62	31784A	4ISA
Stop lamp (when fitted)	1958-60	*31437D (54033234)	22B
ditto Later	1960-62	31688A	6SA
Spring, stop lamp	1958-60	315774	—

ENFIELD 350 c.c. o.h.v. 'Clipper' 1958-62—contd.

Unit	Year	Part No.	Model
LAMPS—continued			
Pilot	1958-62	52234A	550 *
Stop tail, number plate and reflex	1958-62	53432B	564
Magneto (U.S.A. and Special orders)	1961	*42330B (42281)	SR1
ditto	1962	*42330D (42281)	SR1
Rectifier	1958-59	*47111A (47132)	FSW1501A
"	1960-62	47132B	FSX1849
Switches			
Ignition	1959-61	34093B	PR1-2
"	1962	34427A	88SA
Lighting	1958-61	*31491A (31684)	U39
"	1962	34289A	88SA
" (Airflow)	1959-62	31784A	4ISA
Knob	1962	54330934	—
Magneto, cutout (when fitted)	1961-62	76204D	4A
Stop lamp (when fitted)	1960	*31437D (54033234)	22B
ditto Later	1960-62	31688A	6SA
Spring, stop lamp	1960	315774	—

ENFIELD 350 c.c. and 500 c.c. Trials 'Scrambler' 1958-62

Unit	Year	Part No.	Model
Magneto	1958	42157K	KNR1
"	1959-60	42349D	KNC1
" Later	1960-62	42349E	KNC1
" (Competition)	1958	42349D	KNC1

ENFIELD 500 c.c. o.h.v. 'Bullet' 1958-62

Unit	Year	Part No.	Model
Alternator	1958-59	466230	RM14
Rotor	1958-59	468677	RM14
Stator	1959-62	423506	RM15
Rotor Later	1959-62	469427	RM15
Stator Later	1962	54213901	RM19
Rotor	1962	47164A	RM19
Stator	1958-62	36084F	CZU27
Ammeter	1958-59	47556B	—
Auto advance unit	1960-62	47556B	—
ditto (special orders)	1958-61	—	PUZ7E-11
Battery	1958-62	—	—
Cable harness	1958-59	838481	—
"	1960-62	839870	—
" Later	1962	54930095	—
Coil, ignition	1960-62	45077E	MA6
Distributor	1960	*40466B (40712)	15D1
"	1961-62	40712A	15D1
Horn	1958	*069239 (54068034)	HF1234
"	1959-62	*069424 (54068034)	HF1234
Horn push	1962	76204D	4A
Horn push and dip switch	1958-61	31563D	25SA
LAMPS			
Head			
Home and Export, dip left	1958	51856A	MCF700
ditto, vertical dip	1959-62	50943E	MCF700
ditto (Airflow)	1959-62	58258A	F700
Export, vertical dip	1958	50943E	MCF700
Export Europe (not France)	1958-62	51112D	MCF700
Export France	1958-62	51134D	MCF700EF
Pilot	1958-62	52234A	550
Stop tail, number plate and reflex	1958-62	53432B	564
Magneto	1958-59	*42330B (42281)	SR1
" (special orders)	1960-61	*42330B (42281)	SR1
"	1962	*42330D (42281)	SR1
Rectifier	1958-59	*47111A (47132)	FSW1501A
"	1960-62	47132B	FSX1849
Switches			
Cutout, magneto (when fitted)	1961-62	76204D	4A
Dipper	1962	*31549B (31482)	99
Ignition	1960-62	34093B	PR1-2
Lighting	1958-62	*31491A (31684)	U39
" (Airflow)	1959-62	31784A	4ISA
Stop lamp (when fitted)	1958-60	*31437D (54033234)	22B
ditto Later	1960-62	31688A	6SA
Spring, stop lamp	1958-60	315774	—

* When ordering, quote part number shown in brackets



ENFIELD 500 c.c. 'Fury' (Scrambler, U.S.A. only) 1961

Unit	Year	Part No.	Model
Alternator			
Rotor	1961	423506	RM15
Stator	1961	469427	RM15
Ammeter	1961	36084F	CZU27
Battery	1961	—	PUZ7E-11
Cable harness	1961	839800	—
Horn	1961	*069424 (54068034)	HF1234
Horn push	1961	76204D	4A
LAMPS			
Head			
Export, vertical dip	1961	51751A	SSU700
Stop tail, number plate and reflex	1961	53432B	564
Magneto	1961	42272B	NI
Rectifier	1961	47132B	FSX1849
Switches			
Cutout, magneto	1961	76204D	4A
Dipper	1961	*31549B (31482)	99
Lighting	1961	*31491A (31684)	U39
Stop lamp	1961	31688A	6SA

ENFIELD 500 c.c. o.h.v. Twin 1958

Unit	Year	Part No.	Model
Alternator			
Rotor	1958	466230	RM14
Stator	1958	468677	RM14
Ammeter	1958	36084F	CZU27
Battery	1958	—	PUZ7E-11
Cable harness	1958	839870	—
Coil, ignition	1958	45077B	MA6
Distributor	1958	*40550A (40610)	DKX2A
Horn	1958	*069424 (54068034)	HF1234
Horn push and dip switch	1958	31563D	25SA
LAMPS			
Head			
Home, dip left	1958	51856A	MCF700
Export, vertical dip	1958	50943E	MCF700
Export Europe (not France)	1958	51112D	MCF700
Export France	1958	51134D	MCF700EF
Pilot	1958	52234A	550
Stop tail, number plate and reflex	1958	53432B	564
Rectifier	1958	*47111A (47132)	FSW1501A
Switches			
Ignition	1958	34093B	PR1-2
Lighting	1958	*31491A (31684)	U39
Stop lamp	1958	*31437B (54033234)	22B
Spring, stop lamp	1958	315774	—

ENFIELD 500 c.c. o.h.v. 'Meteor Minor' (twin cylinder) 1958-62 and De Luxe and Sports 1960-62

Unit	Year	Part No.	Model
Alternator			
Rotor	1958-59	466230	RM14
Stator	1958-59	468677	RM14
Rotor	1959-62	423506	RM15
Stator	1959-62	469427	RM15
Rotor	1962	54213901	RM19
Stator	1962	47164	RM19
Ammeter	1958-62	36084F	CZU27
Battery	1958-62	—	PUZ7E-11
Cable harness	1958-62	839870	—
.. .. .	1962	54930095	—
Coil, ignition	1958-62	45077B/E	MA6
Distributor	1958	*40550A (40610)	DKX2A
.. .. .	1958-62	40610A	18D2
Horn	1958-62	70142B/D	HF1849
.. .. .	1962	70163A	8H
Horn push (Sports Models)	1961-62	76204D	4A
Horn push and dip switch	1958-62	31563D	25SA
LAMPS			
Head			
Home, dip left	1958	51856A	MCF700
Home and Export, vertical dip	1959-62	50943E	MCF700
ditto (Airflow)	1959-62	58258A	F700
Export, vertical dip	1958	50943E	MCF700
Export Europe (not France)	1958-62	51112D	MCF700
Export France	1958-62	51134D	MCF700EF
Pilot	1958-62	52234A	550
Stop tail, number plate and reflex	1958-62	53432B	564
Magneto	1958	42364A/B	SR2
(Sidecar)	1959-60	42364A/B	SR2
Rectifier	1958-59	*47111A (47132)	FSW1501A
.. .. .	1960-62	47132B	FSX1849
Switches			
Cutout, magneto (when fitted)	1958-60	76204A	4A
Ignition	1959-60	34093B	PR1
.. .. .	1961-62	54033056	63SA
.. .. .	1962	34427A	88SA
Knob	1961-62	54331351	—
Lighting	1958-62	*31491A (31684)	U39
.. .. .	1959-62	31784A	41SA
.. .. .	1962	34289A	88SA
Stop lamp (when fitted)	1958-60	*31437B (54033234)	22B
"Spring, stop lamp"	1960-62	31688A	6SA
.. .. .	1958-60	315774	—

ENFIELD 500 c.c. o.h.v. 'Meteor Minor' (twin cylinder) 1958-62 and De Luxe and Sports 1960-62—contd.

Unit	Year	Part No.	Model
Pilot	1958-62	52234A	550
Stop tail, number plate and reflex	1958-62	53432B	564
Rectifier	1958-59	*47111A (47132)	FSW1501A
.. .. .	1960-62	47132B	FSX1849
Switches			
Dipper (Sports Models)	1960-62	*31549B (31482)	99
Ignition	1958-62	34093B	PR1-2
Lighting	1958-62	*31491A (31684)	U39
.. .. .	1960-62	31784A	41SA
Stop lamp (when fitted)	1958-60	*31437B/D (54033234)	22B
"Spring, stop lamp"	1960-62	31688A	6SA
.. .. .	1958-59	315774	—

ENFIELD 700 c.c. o.h.v. Twin 'Super Meteor' 1958-62

Unit	Year	Part No.	Model
Alternator			
Rotor	1958-59	466230	RM14
Stator	1958-59	468677	RM14
Rotor	1959-62	423506	RM15
Stator	1959-62	469427	RM15
Rotor	1962	54213901	RM19
Stator	1962	47164	RM19
Ammeter	1958-62	36084F	CZU27
Auto-advance unit	1958	47553B	—
Battery	1959-60	47553B	—
(Sidecar)	1958-60	—	PUZ7E-11
.. .. .	1961-62	—	MLZ9E
Cable harness	1958-59	838481	—
.. .. .	1960	839870	—
(Sidecar)	1960	838481	—
.. .. .	1961-62	54947622	—
.. .. .	1962	54930094	—
(Airflow)	1959	54940814	—
.. .. .	1960-62	339870	—
.. .. .	1962	54930095	—
Coil, ignition (from Engine No. SMQA 4614)	1958-62	45077B/E	MA6
Distributor (from Engine No. SMQA 4614)	1958	*40550A (40610)	DKX2A
ditto	1959-62	40610A	18D2
Horn	1958-62	*069424 (54068034)	HF1234
.. .. .	1962	70163A	8H
(Export U.S.A.)	1961	70142D	HF1849
Horn push and dip switch	1958-62	31563D	25SA
LAMPS			
Head			
Home, dip left	1958	51856A	MCF700
Home and Export, vertical dip	1959-62	50943E	MCF700
ditto (Airflow)	1959-62	58258A/B	F700
Export, vertical dip	1958	50943E	MCF700
Export Europe (not France)	1958-62	51112D	MCF700
Export France	1958-62	51134D	MCF700EF
Pilot	1958-62	52234A	550
Stop tail, number plate and reflex	1958-62	53432B	564
Magneto	1958	42364A/B	SR2
(Sidecar)	1959-60	42364A/B	SR2
Rectifier	1958-59	*47111A (47132)	FSW1501A
.. .. .	1960-62	47132B	FSX1849
Switches			
Cutout, magneto (when fitted)	1958-60	76204A	4A
Ignition	1959-60	34093B	PR1
.. .. .	1961-62	54033056	63SA
.. .. .	1962	34427A	88SA
Knob	1961-62	54331351	—
Lighting	1958-62	*31491A (31684)	U39
.. .. .	1959-62	31784A	41SA
.. .. .	1962	34289A	88SA
Stop lamp (when fitted)	1958-60	*31437B (54033234)	22B
"Spring, stop lamp"	1960-62	31688A	6SA
.. .. .	1958-60	315774	—

ENFIELD 700 c.c. o.h.v. Twin 'Constellation' 1958-62

Unit	Year	Part No.	Model
Alternator			
Rotor	1958-59	466230	RM14
Stator	1958-59	468677	RM14

* When ordering, quote part number shown in brackets



ENFIELD 700 c.c. o.h.v. Twin 'Constellation' 1958-62—continued

Unit	Year	Part No.	Model
Alternator—continued			
Rotor	Later	423506	RM15
Stator	Later	469427	RM15
Rotor	Later	54213901	RM19
Stator	Later	47164	RM19
Ammeter	1958-62	36084F	CZU27
Battery	1958-60	—	PUZ7E-11
Cable harness	1961-62	—	MLZ9E
"	1958-60	838481	—
"	1961-62	54947622	—
"	1962	54930094	—
" (Airflow)	1959	54940814	—
"	1960-62	838481	—
Horn	1958-62	*069424 (54068034)	HF1234
" (Export U.S.A.)	1961	70142D	HF1849
Horn push	1962	76204D	4A
Horn push and dip switch	1958-61	31563D	25SA
ditto (Airflow)	1962	31563D	25SA
LAMPS			
Head			
Home, dip left	1958	51856A	MCF700
Home and Export, vertical dip	1959-62	50943E	MCF700
ditto (Airflow)	1959-62	58258A/B	F700
Export, vertical dip	1958	50943E	MCF700
Export Europe (not France)	1958-62	51112D	MCF700
Export France	1958-62	51134D	MCF700EF
Pilot	1958-62	52234A	550
Stop tail, number plate and reflex	1958-62	53432B	564
Magneto	1958-60	42369A	K2F
"	1960-62	42369B	K2F
Rectifier	Later	*47111A (47132)	FSW1501A
"	1958-59	47132B	FSX1849
Switches	1960-62	76204A/D	4A
Cutout, magneto	1958-62	*31549B (31482)	99
Dipper	1962	*31491A (31684)	U39
Lighting	1958-62	*31784A (31684)	41SA
" (Airflow)	1959-62	31784A	22B
Stop lamp (when fitted)	1958-60	*31437B (54033234)	6SA
"	1960-62	31688A	—
"	1958-60	315774	—

FRANCIS BARNETT 172 c.c. t.s. 'Light Cruiser 79' 1959-60

Battery	1959-60	—	MK9E
Cable harness	1959-60	839840	—
LAMPS			
Head			
Home and Export, vertical dip	1959-60	58094A	MCH56
ditto (alternative)	1959-60	58339A	MCH56
Rectifier	1959-60	*47111B (47132)	FSW1501A

FRANCIS BARNETT 197 c.c. t.s. 'Falcon 81' 1958-59

Ammeter	1958-59	36084F	CZU27
Battery	1958-59	—	PUZ7E-10
Cable harness	1958-59	865236	—
"	1958-59	865206	—
Horn	Later	70147A/B	HF1849
LAMPS			
Head			
Home and Export, vertical dip	1958-59	58174A	MCH46
ditto (alternative)	1958-59	58162A	MCH56
Stop tail and number plate	1958-59	53331A	529
Switches	1958-59	31758A	41SA
Lighting	1958-59	31511B	22B
Stop lamp (when fitted)	1958-59	31511B	22B

FRANCIS BARNETT 199 c.c. t.s. 'Falcon 87' 1960-61

Battery	1960-61	—	ML9E
Horn	1960	70151A	HF1849
"	1961	70162A	HF1849
"			continued

FRANCIS BARNETT 199 c.c. t.s. 'Falcon 87' 1960-61—continued

Unit	Year	Part No.	Model
LAMPS			
Stop tail	1960-61	53331A/B	529
Reflex reflector	1960-61	57110A	RER25
Suppressor	1960-61	78118A	WS11
Switches	1960-61	31511B	22B
Stop lamp	1960-61	31511B	22B

FRANCIS BARNETT 249 c.c. t.s. 'Cruiser 80' 1958-61 and 'Cruiser 84' 1959-61

Battery	1958-61	—	PUZ7E-10
Horn	1958	70147A/B	HF1849
"	1959-60	70151A	HF1849
"	1961	70162A	HF1849
LAMPS			
Stop tail	1958-61	53331A	529
Reflex reflector ('80')	1958-61	57110A	RER25
" ('84')	1958-61	57098A	RER22
Suppressor	1958-61	78118A	WS11
Switches	1958-61	31511B	22B
Stop lamp	1958-61	31511B	22B

FRANCIS BARNETT 249 c.c. t.s. 'Trials 83' 1959 'Trials 85' 1960-61 and 'Scrambler 82' 1959-61

LAMPS			
Tail ('83')	1959	53256A	529
Suppressor ('82' and '85')	1959-61	78105A	WS5

INDIAN 250 c.c. o.h.v. 'Fire Arrow' (Hounds) 1958

Alternator			
Rotor	1958	466233	RM13
Stator	1958	468678	RM13
Ammeter (part of headlamp)	1958	36084F	CZU27
Battery	1958	—	PUZ5E-11
Cable harness	1958	839810	—
Horn push and dip switch	1958	31563D	25SA
LAMPS			
Head			
Home and Export, dip left	1958	51751A	SSU700
Stop tail and number plate	1958	53432B	564
Magneto	1958	42272B	N1
Rectifier	1958	*47111A (47132)	FSW1501A
Switches			
Lighting (part of headlamp)	1958	*31491A (31684)	U39
Stop lamp	1958	*31437B (54033234)	22B
Spring, stop lamp	—	315774	—

INDIAN 350 c.c. and 500 c.c. o.h.v. 'Westerner' 1959

Magneto	1959	42272B	N1
-----------------	------	--------	----

INDIAN 500 c.c. o.h.v. 'Tomahawk' 1958

Alternator			
Rotor	1958	466230	RM14
Stator	1958	*468677 (466168)	RM14
Ammeter	1958	36084F	CZU27
Battery	1958	—	PUZ7E-11
Cable harness	1958	839870	—
Coil, ignition	1958	45077B	MA6
Distributor	1958	*40550A (40610)	DKX2A
Horn	1958	*069424 (54068034)	HF1234

continued

* When ordering, quote part number shown in brackets + Suitable Lucas replacement



INDIAN 500 c.c. o.h.v. 'Tomahawk' 1958—contd.

Unit	Year	Part No.	Model
Horn push and dip switch ..	1958	31563D	25SA
LAMPS			
Head	1958	50943E	MCF700
Pilot	1958	52234A	550
Stop tail and number plate ..	1958	53432B	564
Rectifier	1958	*47111A (47132)	FSW1501A
Switches			
Cutout, magneto	1958	76204A	4A
Lighting	1958	*31491A (31684)	U39
Stop lamp	1958	*31437B (54033234)	22B
Spring, stop lamp	—	315774	—

INDIAN 500 c.c. o.h.v. 'Woodsmen' 1958

Alternator			
Rotor	1958	466230	RM14
Stator	1958	*468677 (466168)	RM14
Ammeter (part of headlamp) ..	1958	36084F	CZU27
Battery	1958	—	PUZ7E-11
Cable harness	1958	839800	—
Horn	1958	*069424 (54068034)	HF1234
Horn push and dip switch ..	1958	31563D	25SA
LAMPS			
Head	1958	51751A	SSU700
Stop tail and number plate ..	1958	53432B	564
Magneto (also fitted to 'West Coast Woodsmen') ..	1958	42272B	N1
Rectifier	1958	*47111A (47132)	FSW1501A
Switches			
Lighting (part of headlamp)	1958	*31491A (31684)	U39
Stop lamp	1958	*31437B (54033234)	22B
Spring, stop lamp	—	315774	—

INDIAN 700 c.c. o.h.v. Twin 'Trail Blazer' 1958

Alternator			
Rotor	1958	466230	RM14
Stator	1958	*468677 (466168)	RM14
Ammeter (part of headlamp) ..	1958	36084F	CZU27
Auto-advance unit	1958	47553B	—
Battery	1958	—	PUZ7E-11
Cable harness	1958	838481	—
Horn	1958	865129	—
Horn	1958	*069424 (54068034)	HF1234
Horn push and dip switch ..	1958	31563D	25SA
LAMPS			
Head	1958	51751A	SSU700
.. .. .	1958	58155A	MCH52
.. .. .	1958	53432B	564
Stop tail and number plate ..	1958	42364B	SR2 Mk. IIA
Magneto	1958	42364B	FSW1501A
Rectifier	1958	*47111A (47132)	FSW1501A
Switches			
Cutout, magneto	1958	76204A	4A
Lighting	1958	*31491A (31684)	U39
Stop lamp	1958	*31437B (54033234)	22B
Spring, stop lamp	—	315774	—

INDIAN 700 c.c. o.h.v. Twin 'Apache' 1958-59

Alternator			
Rotor	1958-59	466230	RM14
Stator	1958-59	*468677 (466168)	RM14
Rotor	1959	423506	RM15
Stator	1959	469427	RM15
Ammeter (part of headlamp) ..	1958-59	36084F	CZU27
Battery	1958-59	—	PUZ7E-11
Cable harness	1958-59	839800	—
Horn	1958-59	*069424 (54068034)	HF1234

INDIAN 700 c.c. o.h.v. Twin 'Apache' 1958-59 —continued

Unit	Year	Part No.	Model
Horn push	1959	76204A	4A
Horn push and dip switch ..	1958	31563D	25SA
LAMPS			
Head	1958-59	51751A	SSU700
Stop tail and number plate ..	1958-59	53432B	564
Magneto	1958-59	42369A	K2F
Rectifier	1958-59	*47111A (47132)	FSW1501A
Switches			
Cutout, magneto	1958-59	76204A	4A
Dipper	1959	*31549A (31482)	99
Lighting (part of headlamp)	1958-59	*31491A (31684)	U39
Stop lamp	1958-59	*31437B (54033234)	22B
Spring, stop lamp	—	315774	—

INDIAN 700 c.c. o.h.v. Twin 'Chief' 1959

Alternator			
Rotor	1959	466230	RM14
Stator	1959	*468677 (466168)	RM14
Rotor	1959	423506	RM15
Stator	1959	469427	RM15
Ammeter	1959	36084F	CZU27
Battery	1959	—	GW11E
Cable harness	1959	54942360	—
Coil, ignition	1959	45077B	MA6
Distributor	1959	40610A	18D2
Horn	1959	*069424 (54068034)	HF1234
Horn push and dip switch ..	1959	31563D	25SA
LAMPS			
Head	1959	58383A	MCH60
Adaptor (order separately)	1959	865130	—
Stop tail and number plate ..	1959	53432B	564
Rectifier	1959	*47111A (47132)	FSW1501A
Switches			
Lighting	1959	*31491A (31684)	U39
Stop lamp	1959	*31437B (54033234)	22B
Spring, stop lamp	1959	315774	—

INDIAN MOTOR CYCLES 1960-62

'Indian' equivalents for the Matchless range are as follows:

English designation	American designation
G12CS or G12CSR	650 c.c. o.h.v. 'Apache'
G12	650 c.c. o.h.v. 'Trailblazer'
G80CS	500 c.c. o.h.v. 'Westerner' or 'Woodsmen'
G50CSR	500 c.c. o.h.v. 'Racer'
G2	250 c.c. o.h.v. 'Pathfinder'
G2CS	250 c.c. o.h.v. 'Arrow'

N.B.—For details of equipment specifications for the above 'Indian' models reference should be made to the equivalent models in the 'Matchless' range—(see pages 13-15).

JAMES 98 c.c. t.s. 'Comet LI' 1958-62

Battery	1958-61	—	PUZ5E-11
.. .. .	1962	—	PUZ5E-10
Cable harness	1958-62	838981	—
LAMPS			
Head			
Home and Export, dip left (grey)	1958-62	58111A	MCH56
Home and Export, dip left (maroon)	1958-62	58149A	MCH56
Tail and number plate	1958-62	53256A	—
Switches			
Dipper	1958-62	31549B	99
Lighting	1958-62	31721B	41SA

JAMES 147 c.c. t.s. 'Cadet L15' 1958-59 and 149 c.c. 'Flying Cadet L15A' 1960-62

Ammeter	1958-59	36084F	CZU27
Battery	1958-59	—	PUZ5E-10

* When ordering, quote part number shown in brackets



JAMES 147 c.c. t.s. 'Cadet L15' 1958-59 and 149 c.c. 'Flying Cadet L15A' 1960-62

—continued

Unit	Year	Part No.	Model
Battery	1960-61	—	PUZ5E-11
	1962	—	PUZ5E-10
Cable harness (direct lighting)	1958-59	838981	—
	1958-59	838971	—
Horn	1958-59	*†70146A/B (70142)	HF1849
Horn push and dip switch	1958-59	31563D	25SA
LAMPS			
Head			
Home and Export, dip left (grey, direct)	1958-59	58111A	MCH56
Home and Export, dip left (maroon, direct)	1958-59	58149A	MCH56
Home and Export, dip left (grey, rectified)	1958-59	58112A	MCH56
Home and Export, dip left (maroon, rectified)	1958-59	58150A	MCH56
Switches			
Lighting (rectified)	1958-59	31718A	41SA
	1958-59	31721B	41SA

JAMES 149 c.c. t.s. Scooter 'SCI' 1962

Battery	1962	—	MLZ9E
Horn	1962	70163A	8H

JAMES 175 c.c. t.s. 'Cavaller L17' 1958-59

Alternator			
Rotor	1958-59	54210413	RM13
Stator	1958-59	468678	RM13
Ammeter	1958-59	36084F	CZU27
Battery	1958-59	—	PUZ5E-10
Cable harness	1958-59	54940078	—
Coil, ignition	1958-59	45077B/E	MA6
Contact breaker	1958-59	47573D	IMP52
Horn	1958-59	*†70146B (70142)	HF1849
LAMPS			
Head			
Home and Export, dip left (grey)	1958-59	51997B	MCH56
Home and Export, dip left (maroon)	1958-59	58259A	MCH56
Switches			
Lighting	1958-59	31443E	PRS8
Knob	—	318346	—

JAMES 197 c.c. 'Captain K7' 1958-59 199 c.c. t.s. 'Captain L20' 1960-62 and 'Sports Captain L20S' 1962

Alternator			
Rotor	1960-61	466125	RM13
Stator	1960-61	468678	RM13
Ammeter (in headlamp)	1958-61	36084F	CZU27
Battery	1958-59	—	PUZ7E-10
	1960-62	—	PUZ7E-11
Cable harness	1958-59	54940310	—
Coil, ignition	1960-61	45077A/E	MA6
Contact breaker	1960-61	47574F	3CA
Horn	1958-62	*†70146A/B (70142)	HF1849
Horn push and dip switch	1958-59	31563D	25SA
LAMPS			
Head			
Home and Export, vertical dip (grey)	1958-59	58216A	MCH56
Home and Export, vertical dip (maroon)	1958-59	58215A	MCH56
Home and Export, vertical dip (grey)	1960-61	58348A	MCH56
Home and Export, vertical dip (maroon)	1960-61	58349A	MCH56
Rectifier	1960-61	47132B	FSX1849
Switches			
Lighting (in headlamp)	1958-59	31758A	41SA
	1960-61	31443A/E	PRS8

JAMES 249 c.c. t.s. 'Commodore L25' 1958-62 and 'Super Swift M25' 1962

Battery	1958-62	—	PUZ7E-11
Horn	1958-62	*†70146A/B (70142)	HF1849
Horn push and dip switch	1958-59	31563D	25SA

MATCHLESS 250 c.c. o.h.v. 'G2', 'G2CS' and 'Clubman' 1959-62 'G2 Monitor' and 'G2S Monitor Sports' 1962 and 350 c.c. o.h.v. 'G5 Matador' 1960-62

Unit	Year	Part No.	Model
Battery	1959	—	PUZGE-11
	1960-62	—	PUZ7E-11
Horn	1959-61	*70146B (70142)	HF1859
	1962	70163A	8H

MATCHLESS 350 c.c. o.h.v. 'G3LS' 1958 and 'G3 Mercury' and 'G3S Mercury Sports' 1959-62

Alternator			
Rotor	1958-62	423506	RM15
Stator	1958-62	47122A	RM15
Ammeter (part of headlamp)	1958-62	36084F	CZU27
Battery	1958-59	—	PUZ7E-11
	1960-61	—	MLZ9E
	1962	—	PUZ7E-11
Cable harness	1958-59	865225	—
	1960-62	54944148	—
	1962	54949913	—
Coil, ignition	1958-62	45077B/E	MA6
Contact breaker	1958-61	47578D/H	CA1A
	1962	47595A	CA1A
Horn	1958-61	*70137 (70048)	HF1441
	1962	70163A	8H
Horn push and dip switch	1958-62	31563D	25SA
LAMPS			
Head			
Home and Export, dip left	1958-59	58135A	MCH57
	1960-62	58409A	MCH61
" ditto " Later	1962	58702A	MCH61
Export, vertical dip	1958-59	58136A	MCH57
Export Europe (not France)	1958-59	58137A	MCH57
	1960-62	58514A	MCH61
" ditto " Later	1962	58832A	MCH61
Export France	1958-59	58138A	MCH57EF
	1960-62	58515A	MCH61EF
" Later	1962	58833A	MCH61EF
Stop tail, number plate and reflex	1958-62	53432B	564
Rectifier	1958-59	*47111A (47132)	FSW1501A
	1959-62	47132A/B	FSX1849
Switches			
Ignition (part of headlamp)	1960-62	54033027	63SA
ditto Later	1962	34287A	88SA
Knob	—	54332498	—
Lighting (part of headlamp)	1960-62	54033109	63SA
ditto Later	1962	34289A	88SA
Knob	—	54330934	—
Lighting and ignition (part of headlamp)	1958-59	31443E	PRS8
Knob	—	318346	—
Stop lamp	1958-62	31384B	22B
Spring, stop lamp	1958-62	315543	—

MATCHLESS 350 c.c. o.h.v. 'G3LCS', 'G3C', 'G3CS' and 'G3C Maestro' (Competition Models) 1958-62

Ammeter (part of headlamp)	1958-62	36084F	CZU27
Battery	1958-62	—	PUZ7E-11
Cable harness	1958	838671	—
	1959-61	54941907	—
	1962	54949915	—
Control box	1958	37144A	MCR2
	1958	37144B	MCR2
	1959-60	37232H	RB108
	1960-62	37232J/K	RB108
Generator	1958-62	20038B	E3N
Horn	1958-61	*059446 (54068034)	HF1234
	1962	70163A	8H
Horn push	1958-61	76204A	4A
Horn push and dip switch	1962	31563D	25SA
LAMPS			
Head			
Home and Export	1958	*50791D (51625)	MU42
	1959-62	58224D	SSU700P
Stop tail and number plate	1958	53432B	564
ditto (U.S.A. only)	1958	53429A	529
ditto	1959-62	53429A/B	529
Magneto	1958-62	*42347D (42371)	NC1
	1962	*42347E (42371)	NC1

continued



MATCHLESS 350 c.c. o.h.v. 'G3LCS', 'G3C', 'G3CS' and 'G3C Maestro' (Competition Models) 1958-62—contd.

Table with 4 columns: Unit, Year, Part No., Model. Includes Magneto, Reflex reflector, Switches, Dipper, Lighting, Stop lamp, Spring, stop lamp.

MATCHLESS 500 c.c. o.h.v. 'G50CSR' (Export U.S.A. only) 1962

Table with 4 columns: Unit, Year, Part No., Model. Includes Ammeter, Battery, Cable harness, Control box, Generator, Horn, Horn push and dip switch, LAMPS, Magneto, Reflex reflector, Switches, Lighting, Stop lamp, Spring, stop lamp.

MATCHLESS 500 c.c. o.h.v. 'G80', 'G80S', and 'Major' 1958-62

Table with 4 columns: Unit, Year, Part No., Model. Includes Alternator, Rotor, Stator, Ammeter, Battery, Cable harness, Coil, ignition, Contact breaker, Horn, Horn push and dip switch, LAMPS, Magneto, Reflex reflector, Switches, Lighting, Stop lamp, Spring, stop lamp.

MATCHLESS 500 c.c. o.h.v. 'G80CS' and 'G80CS Marksman' (Competition Models) 1958-62

Table with 4 columns: Unit, Year, Part No., Model. Includes Alternator, Rotor, Stator.

MATCHLESS 500 c.c. o.h.v. 'G80CS' and 'G80CS Marksman' (Competition Models) 1958-62—continued

Table with 4 columns: Unit, Year, Part No., Model. Includes Ammeter, Battery, Cable harness, Control box, Generator, Horn, Horn push, Horn push and dip switch, LAMPS, Magneto, Rectifier, Reflex reflector, Switches, Dipper, Lighting, Stop lamp, Spring, stop lamp.

MATCHLESS 500 c.c. o.h.v. Twin 'G9' 1958-61, 600 c.c. o.h.v. Twin 'G11' 1958, 650 c.c. o.h.v. Twin 'G12 Majestic' 1959-62

Table with 4 columns: Unit, Year, Part No., Model. Includes Alternator, Rotor, Stator, Battery, Cable harness, Coil, ignition, Control box, Distributor, Generator, Horn, Horn push and dip switch, LAMPS, Magneto, Reflex reflector, Switches, Dipper, Lighting, Stop lamp, Spring, stop lamp.

* When ordering, quote part number shown in brackets



MATCHLESS 500 c.c. o.h.v. Twin 'G9' 1958-61 600 c.c. o.h.v. Twin 'G11' 1958 650 c.c. o.h.v. Twin 'G12 Majestic' 1959-62—continued

Unit	Year	Part No.	Model
LAMPS—continued			
Export Europe .. Later	1962	58832A	MCH61
Export France	1958	58180A	MCH57EF
" Later	1958	58154A	MCH57EF
"	1960-62	58517A	MCH61EF
" Later	1962	58833A	MCH61EF
Stop tail and number plate ..	1958-62	53432B	564
Magneto	1958	42230D	K2F
" (optional and Sports—U.S.A. only) ..	1958	*42264A (42380)	K2F
"	1962-62	*42264D (42380)	K2F
Rectifier	1959	*47111A (47132)	FSW1501
" Later	1959-62	47132A	FSX1849
Switches			
Cutout, magneto (when fitted)	1962	76204A/D	4A
Ignition (part of headlamp) ..	1960-62	54033056	63SA
ditto Later	1962	34287A	88SA
Knob	—	54332498	—
Lighting (part of headlamp) ..	1958	31340A	U39
ditto Later	1958	31754A	41SA
ditto	1960-62	54033028	63SA
ditto Later	1962	34289A	88SA
Knob	—	54330934	—
Lighting and ignition (part of headlamp) ..	1959	*31460A (31443)	PR58
Knob	—	318346	—
Stop lamp	1958-62	31384B	22B
Spring, stop lamp	1958-62	315543	—

MATCHLESS 500 c.c. o.h.v. 'G9DeL' De Luxe Twin 1959 and 650 c.c. o.h.v. 'G12DeL' De Luxe Twin 1959-61

Ammeter	1959-61	36084F	CZU27
Battery	1959	—	PUZ7E-11
"	1960-61	—	MLZ9E
Cable harness	1959	54942037	—
"	1960-61	54944150	—
Control box	1959-61	37252A	RB108
" Later	1961	37252B/D	RB108
Generator	1959-61	20035A	E3L
Horn	1959-61	*70137A (70048)	HF1441
Horn push	1959	76204A	4A
Horn push and dip switch ..	1960-61	31563D	35SA
LAMPS			
Head			
Home and Export, vertical dip	1959	58152A	MCH57
ditto	1960-61	58477A	MCH61
Export Europe (not France) ..	1960-61	58518A	MCH61
Export France	1960-61	58519A	MCH61EF
Stop tail and number plate ..	1959-61	53432B	564
Magneto	1959-61	42230D	K2F
" Later	1961	42230E	K2F
Switches			
Cutout, magneto	1959-61	76204A	4A
Dipper	1959-61	31482A	9
Lighting	1959	*31754A/B (31763)	41SA
"	1960-61	54033028	63SA
Knob	—	54330934	—
Stop lamp	1959-61	31384B	22B
Spring, stop lamp	—	315543	—

MATCHLESS 500 c.c. o.h.v. Twin 'G9CS' and 'G9CSR' 1959 and 650 c.c. o.h.v. Twin 'G12CS', 'G12CSR' and 'Monarch' 1959-62

Alternator	1962	423506	RM15
Rotor	—	47154A	RM15
Stator	—	—	—
Ammeter (Part of headlamp) ..	1959-62	36084F	CZU27
" (when fitted)	1962	36296A	3AR
Battery	1959	—	PUZ7E-11
"	1960-61	—	MLZ9E
"	1962	—	PUZ7E-11
Cable harness	1959	54941907	—
"	1960-61	54943365	—
"	1962	54949911	—
" ditto (12CSR and U.S.A. models)	1962	54949912	—

MATCHLESS 500 c.c. o.h.v. Twin 'G9CS' and 'G9CSR' 1959 and 650 c.c. o.h.v. Twin 'G12CS', 'G12CSR' and 'Monarch' 1959-62 —continued

Unit	Year	Part No.	Model
Control box	1959-61	37225E	RB108
" Later	1959-61	37225F	RB108
Generator	1959-61	20035A	E3L
Horn	1959	*70136A (70048)	HF1441
"	1960-61	*70137A (70048)	HF1441
"	1962	70163A	8H
Horn push	1959-61	76204A	4A
Horn push and dip switch ..	1962	31563D	35SA
LAMPS			
Head			
Home and Export, vertical dip	1959-61	58224D	SSU700
ditto	1962	58229A	MCH61
ditto (650 c.c.)	1962	58704A	MCH61
ditto (optional)	1962	58258B	F700P
Export, U.S.A. (650 c.c.) ..	1961-62	58556A	SS700P
Export Europe (not France) (650 c.c.)	1962	58830A	MCH61
Export France (650 c.c.) ..	1962	58831A	MCH61EF
Stop tail and number plate ..	1959-62	53429A	529
Magneto	1959	*42264A (42380)	K2F
"	1959-61	*42264B (42380)	K2F
"	1961-62	*42264D (42380)	K2F
Rectifier	1962	47132B	FSX1849
Switches			
Cutout, magneto	1959-62	76204A	4A
Dipper	1959-61	31482A	9
Lighting (part of headlamp) ..	1959-61	31754A/B	41SA
" (650 c.c.—U.S.A. only)	1962	31784D	41SA
ditto	1962	34289A	88SA
Knob	—	54330934	—
Stop lamp	1959-62	31384B	22B
Spring, stop lamp	—	315543	—

NORTON 250 c.c. o.h.v. 'Jubilee' Twin 1960-62

Horn	1960-61	*70153A (70155)	5H
" (Export Switzerland) ..	1960-61	*70136A (70048)	HF1441
"	1962	70163A	8H
LAMPS			
Stop tail and number plate ..	1962	53432B	564

NORTON 348 c.c. o.h.v. '40 International' and 490 c.c. o.h.v. '30 International' 1958

Ammeter (part of headlamp) ..	1958	36084F	CZU27
Battery	1958	—	PUZ7E-11
Cable harness	1958	838341	—
" Later	1958	839021	—
Control box	1958	37225E	RB108
Generator (part of magdyno) ..	1958	20034A	E3L
Horn	1958	*069239N (54068034)	HF1234
Horn push and dip switch ..	1958	31563A	35SA
LAMPS			
Head			
Home, dip left	1958	*51876B (51954)	MCH58
" Later	1958	31954A	MCH61
Export, vertical dip	1958	58019A	MCH61
Export Europe (not France) ..	1958	58020A	MCH61
Export France	1958	58021A	MCH61EF
Stop tail and number plate ..	1958	53432B	564
Magdyno	1958	46047A	MO1L
Switches			
Lighting (part of headlamp) ..	1958	31340A	U39
ditto Later	1958	*31626A (31676)	41SA
Knob	1958	351567	—
"	1958	351788	—
Stop lamp	1958	*31437B (54033234)	22B

* When ordering, quote part number shown in brackets



NORTON 650 c.c. o.h.v. 'Manxman' (U.S.A. only) 1961-62 and 650 c.c. 'SS Dominator' 1962—contd.

Unit	Year	Part No.	Model
Ammeter (part of headlamp) ..	1961-62	36084F	CZU27
Auto-advance unit	1961-62	47508D	K2F
Battery	1961-62	—	PUZ7E-11
Cable harness	1961	54947957	—
"	1962	54949940	—
Horn	1961	70140A	HF1441
"	1962	70163A	8H
Horn push and dip switch ..	1961-62	31563A/D	25SA
LAMPS			
Head			
Home and Export, vertical dip (except 'Manxman')	1962	58241A/B	MCH61
Export U.S.A.	1961-62	58761A	MCH61
Stop tail and number plate ..	1961-62	53432B	564
Magneto	1961-62	42368D	K2FC
Rectifier	1961-62	47132B	FSX1849
Switches			
Cutout, magneto	1961-62	76204A	4A
Lighting (part of headlamp)	1961-62	31784A/D	41SA
Knob	—	351815	—
Stop lamp	1961-62	31383B	22B

NORTON 745 c.c. o.h.v. Twin 'Atlas' (America only) 1962—

Unit	Year	Part No.	Model
Alternator			
Rotor	1962	54213901	RM19
Stator	1962	47162A	RM19
Ammeter (part of headlamp) ..	1962	36084F	CZU27
Auto-advance unit	1962	47508D	—
Battery	1962	—	PUZ7E-11
Cable harness	1962	54949940	—
Horn	1962	70163A	8H
Horn push and dip switch ..	1962	31563D	25SA
LAMPS			
Head			
Home and Export, vertical dip	1962	58241A	MCH61
Stop tail and number plate ..	1962	53432B	564
Magneto	1962	42368D	K2FC
Rectifier	1962	47132B	FSX1849
Switches			
Cutout, magneto	1962	76204A	4A
Lighting and ignition (part of headlamp) ..	1962	31784A/D	41SA
Knob	—	351815	—
Stop lamp	1962	31383A/B	22B

PANTHER 175 c.c. t.s. 'Princess' Scooter (6 volt) 1959-62

Unit	Year	Part No.	Model
Ammeter	1959-62	36084F	CZU27
Battery	1959-62	—	MLZ9E
Cable harness	1959-60	54944902	—
"	1961-62	54945941 B	—
LAMPS			
Head			
Home and Export, vertical dip	1959-62	58552A	MCF575P
Stop tail and number plate ..	1959-62	53394B	564
Switches			
Ignition	1959-62	31403H	S45
Lock	—	345070	—
Lighting	1959-62	31758A	41SA
Stop lamp	1959-62	*31437B (54033234)	22B
Warning lights			
Neutral indicator	1960-62	*319383 (319107 & 319222)	WL13
Bulb holder	1960-62	863511	—
Bulb	1960-62	990	—

PANTHER 175 c.c. t.s. 'Princess' Scooter (12 volt, electric starting) 1959-62

Unit	Year	Part No.	Model
Battery (2 off)	1959-62	—	MLZ9E
Cable harness	1959-60	54943631	—
"	1961-62	54945943B	—
LAMPS			
Head			
Home and Export, vertical dip	1959-62	58475A	MCF575P
Tail and number plate	1959-62	53454B	564

continued

PANTHER 175 c.c. t.s. 'Princess' Scooter (12 volt, electric starting) 1959-62—continued

Unit	Year	Part No.	Model
Switches			
Ignition	1959-62	31403H	S45
Lock	—	345070	—
Lighting	1959-62	54033028	63SA
Starting motor	1959-62	*31071A/B (31107)	SS5
Stop lamp	1959-62	*31437B (54033234)	22B
Spring, stop lamp	—	315738	—
Warning lights			
Ignition	1959	*38134A (38049)	WL13
"	1960-62	*319335 (319106 & 319222)	WL13
Neutral indicator	1960-62	*319383 (319107 & 319222)	WL13
Bulb holder	1960-62	863511	—
Bulb	1960-62	987	—

PANTHER 197 c.c. t.s. '10/3' 1959-61, '10/3A' and '10/4' 1959-62

Unit	Year	Part No.	Model
Ammeter (part of headlamp) ..	1959	36084F	CZU27
Battery	1959	—	PUZ7E-10
"	1960-61	—	PUZ7E-11
"	1962	—	PUZ5E-11
Cable harness (10/3)	1959-60	54943613	—
"	1961	54943687	—
" (10/3A and 10/4)	1959-62	54940190	—
Horn push and dip switch ..	1959	31563A/D	25SA
LAMPS			
Head			
Home and Export, vertical dip			
10/3	1959-61	58483A	MCH56
10/3A and 10/4	1959-62	58215A	MCH56
Stop tail and number plate ..	1959-62	53394B	564
Switches			
Lighting (part of headlamp)			
10/3	1959-61	31718A	41SA
10/3A and 10/4	1959-62	31758A	41SA
Stop lamp	1959-62	*31437B (54033234)	22B
Spring, stop lamp	—	315543	—
Rubber pad	1959-62	380459	—

PANTHER 249 c.c. t.s. Twin '35' 1959-61 and '35' Sports 1959-62

Unit	Year	Part No.	Model
Ammeter (part of headlamp) ..	1959-62	36084F	CZU27
Battery	1959	—	PUZ7E-10
"	1960-62	—	PUZ5E-11
Cable harness	1959-60	54943628	—
"	1961-62	54944333	—
Horn push and dip switch ..	1959-62	31563A/D	25SA
LAMPS			
Head			
Home and Export, vertical dip			
1959-60	1959-60	58470A	MCH56
ditto	1961	58472A	MCH56
ditto (Sports)	1959-61	58471A	MCH56
ditto	1962	58472A	MCH56
Stop tail and number plate ..	1959-62	53432B	564
Switches			
Lighting (part of headlamp)	1959-62	31784A/D	41SA
Escutcheon plate	—	351803	—
Stop lamp	1959-62	*31437B (54033234)	22B
Spring, stop lamp	1959	315738	—
"	1960-62	315543	—
Rubber pad	1959-62	380459	—

PANTHER 250 c.c. o.h.v. '65' 1958-61

Unit	Year	Part No.	Model
Ammeter (part of headlamp)			
Coil ignition	1958-61	36184B	CZU27
Magneto ignition	1959-61	36084F	CZU27

continued

* When ordering, quote part number shown in brackets



PANTHER 250 c.c. o.h.v. '65' 1958-61—continued

Unit	Year	Part No.	Model
Battery	1958	—	PUZ7E-9
	1959-61	—	PUZ7E-10
Cable harness	1958-61	839441	—
Coil ignition	1959-61	839401	—
Magneto ignition	1958-61	45077B/E	MA6
Coil, ignition	1958-61	37225E/J	R8108
Control box	1958-61	40145E/F	DKX1A
Distributor (coil ignition)	1958-61	20035A/B	E3L
Generator	1958-61	*069239	HF1234
Horn	1958-61	(54068034)	—
		76210A	4A
Horn push (coil ignition)	1958-61	—	—
Horn push and dip switch (magneto ignition)	1959-61	31563A/D	25SA
LAMPS			
Head			
Home and Export, vertical dip	1958-61	58037A	MCH61
Coil ignition	1959-61	58091A/B	MCH61
Magneto ignition	1958-61	53432B	564
Stop tail and number plate	1958-61	42183F	K1F
Magneto	1959-60	42183H	K1F
Later	1960-61	—	—
Switches			
Dipper (coil ignition)	1958-61	*31278A (31482)	99
Lighting and ignition (part of headlamp)			
Coil ignition	1958-61	34080A	PLC5
Magneto ignition	1959-60	*31626A (31676)	41SA
"	1961	*31754A (31763)	41SA
Stop lamp	1958-61	*31437B (54033234)	22B
Spring, stop lamp	—	315738	—

PANTHER 324 c.c. t.s. Twin '45' and '50' Grand Sports 1959-62

Ammeter (part of headlamp)	1959-62	36084F	CZU27
Battery	1959	—	PUZ7E-10
	1960-62	—	PUZ5E-11
Cable harness	1959-60	54943628	—
	1961-62	54944333	—
Horn push and dip switch	1959-62	31563A/D	25SA
LAMPS			
Head			
Home and Export, vertical dip	1959-62	58472A	MCH56
ditto (Sports)	1959-62	58442A	MCH61
Stop tail and number plate	1959-62	53432B	564
Switches			
Lighting (part of headlamp)	1959-62	31784A/D	41SA
Escutcheon plate	—	351803	—
Stop lamp	1959-62	*31437B (54033234)	22B
Spring, stop lamp	1959	315738	—
	1960-62	315543	—
Rubber pad	1959-62	380459	—

PANTHER 350 c.c. o.h.v. '75' 1958-62

Ammeter (part of headlamp)	1958-62	36084F	CZU27
Battery	1958	—	PUZ7E-9
	1959-62	—	PUZ7E-10
Cable harness	1958	839171	—
	1959-62	839401	—
Control box	Later	—	—
Generator	1958-62	37225E/J	R8108
Horn	1958-62	20035A/B	E3L
	1958-62	*069239	HF1234
	1958-62	(54068034)	—
Horn push and dip switch	1958-62	31563A/D	25SA
LAMPS			
Head			
Home and Export, vertical dip	1958	*51801E (58091)	MCH58
ditto	Later	—	—
Stop tail and number plate	1958-62	58091A/B	MCH61
Magneto	1958-60	53432B	564
	1958-60	42183F	K1F
Later	1960-62	42183H	K1F
Switches			
Lighting (part of headlamp)	1958	31340A	U39
ditto	Later	*31626A (31676)	41SA
ditto	Later	*31754A (31763)	41SA
Stop lamp	1958-62	*31437B (54033234)	22B
Spring, stop lamp	1958-62	315738	—
Bracket, stop lamp	1962	317578	—
Rubber pad	1958-62	380459	—

PANTHER 600 c.c. o.h.v. '100' 1958-62 and 650 c.c. o.h.v. '120' 1959-62

Unit	Year	Part No.	Model
Ammeter (part of headlamp)	1958-62	36084F	CZU27
Battery	1958	—	PUZ7E-9
	1959-62	—	PUZ7E-10
Cable harness	1958-60	839422	—
	1961-62	839421	—
Control box	1958-62	37225E/J	R8108
Generator (part of magdyno)	1958-62	20034A	E3LM
Horn	1958	*069239	HF1234
	1959-62	(54068034)	—
	1959-62	*069498 (54068034)	HF1234
Horn push (rigid frame)	1958	76210A	4A
Horn push and dip switch (spring frame)	1958-62	31563A/D	25SA
LAMPS			
Head			
Home and Export, vertical dip	1958	*51706A (51709)	MCH55
Rigid frame	1958-62	58092A/B	MCH61
Spring frame	1959-62	52268E	569
Sidescar (120 only)	1958-62	53432B	564
Stop tail and number plate	1958-62	46047B	MO1L
Magdyno	1958-62	—	—
Switches			
Dipper (rigid frame)	1958	*31278A (31482)	99
Lighting (part of headlamp)			
Rigid frame	1958	31340A	U39
Spring frame	1958-60	*31754A (31676)	41SA
"	1961-62	*31754A (31763)	41SA
Stop lamp	1958-62	*31437B	22B
Spring, stop lamp	1958-62	315738	—
Bracket, stop lamp	1962	317578	—
Rubber pad	1958-62	380459	—

RALEIGH 'Moped' 1958-60

Horn set (optional)	1958-60	54068000	—
Comprising:			
5Horn	—	70145D	HF1930
5Horn push	—	76204D	4A
Bracket, mounting	—	54680279	—
Connector, snap, double	—	850641	—
Washer, spring	—	185040	—
Nut	—	166019	—
Bolt, short	—	110714	—
Bolt, long	—	126589	—
LAMPS			
Head			
Home and Export, dip left	1958-60	54052019	MCH64
Tail and number plate	1958-60	53555A/D	590
Magdyno			
Flywheel	1958-60	54440610	7F1
Stator	1958-60	42376B	7F1
Switches			
Lighting (part of headlamp)	1958-60	*31766A/B (54033018)	61SA
Knob	—	54331313	—

TRIUMPH 173 c.c. 'Tigress' (TS1) Scooter 1959-62

Battery	1959-62	—	MLZ9E
Horn	1959	70153E	5H
	1960-62	70155A	5H
Horn push and dip switch	1959	31563	25SA
Suppressor	1960-62	78106A	WS5

TRIUMPH 200 c.c. 'Tiger Cub T20' 1958-62

Alternator			
Rotor	1958-62	466124	RM13
Stator	1958-60	468678	RM13
	1961-62	47137A	RM13
Battery	1958-62	—	PUZ5E-11
Cable harness	1958-62	*839102 (839101)	—
Coil, ignition	1958-62	45077B/E	MA6
Distributor	1958-59	*40529A/B (40699)	15D1
"	1960-62	40699A/B	15D1

* When ordering, quote part number shown in brackets



TRIUMPH 200 c.c. 'Tiger Cub T20' 1958-62 —continued

Unit	Year	Part No.	Model
LAMPS			
Head			
Home and Export, dip left	1958-62	51519B	MCF575P
Export Europe (not France)	1958-62	51547D	MCF575P
Export France	1958-62	51634B	MCF575PEF
Export U.S.A.	1958-62	51548D	MCF575
Stop tail and number plate (Export only)	1958-62	53331A	529
Stop tail, number plate and reflex	1962	53394B	564
Tail and number plate	1958-61	53256A	529
Rectifier	1958-59	*47111A (47132)	FWS1501A
	Later	47132B	FSX1849
Reflex reflector (Home only)	1958-61	57080A	RER16
Switches			
Dipper	1958-62	*31549A/B (31482)	99
Lighting and ignition	1958-62	31443E	PRS8
Knob	1958-62	318346	—
Stop lamp	1958-62	*31437B (54033234)	22B
Spring, stop lamp	1958-62	315738	—

TRIUMPH 200 c.c. 'Tiger Cub' Models T20C, T20S, T20SL, T20T, T20SS, T20SR and T20SC 1959-62

Alternator			
Rotor	1959-60	466124	RM13
Stator	1959-60	*47138A/B (47175)	RM13
Rotor	1961-62	466124	RM13
Stator	1961-62	47177A	RM13
Rotor	1962	54213901	RM19
Stator	Later	47173A	RM19
Cable harness			
Less lights	1959-62	5494388A	—
With lights	1959-62	5494267B	—
Coil, ignition	1959-62	45112A/D	2ET
Distributor	1959-60	40664A/B	15D1
	1960-62	40700A/B	15D1
Horn	1959-62	70145D	HF1950
Horn push	1959-62	76204A/D	4A
LAMPS			
Head			
Home	1959-62	58935A	MCH66
Stop tail and number plate	1961	53429A	529
Stop tail, number plate and reflex	1962	53394B	564
Tail and number plate	1959-60	53428B	529
Rectifier	1959-62	47132B	FSX1849
Reflex reflector	1959-62	57080A	RER16
Switches			
Cutout, engine	1959-62	76204A/D	4A
Dipper (part of headlamp)	1959-62	31620B/E	PS9
Stop lamp	1961-62	*31437B/D (54033234)	22B
Spring, stop lamp	1961-62	315738	—

TRIUMPH 200 c.c. 'Tiger Cub T20SH' 1962

Alternator			
Rotor	1962	54213903	RM18
Stator	1962	47161A	RM18
Battery	1962	—	PUZ5E-11
Cable harness	1962	54931230	—
Coil, ignition	1962	45077E	MA6
Distributor	1962	40699B	15D1
Horn	1962	70163A	8H
LAMPS			
Head			
Home	1962	58935A	MCH66
Stop tail and number plate	1962	53394B	564
Rectifier	1962	47132B	FSX1849
Switches			
Dipper	1962	31620B/E	PS9
Ignition	1962	34427A	88SA
Lighting	1962	34289A	88SA
Knob	—	54330934	—

TRIUMPH 250 c.c. 'Tigress' (TW2) Scooter (6 volt) 1959-62

Alternator			
Rotor	1959-62	54210940	5AF
Stator	1959-62	47136A/B	5AF
Battery	1959-62	—	MLZ9E
Cable harness	1959-62	54941657	—
Coil, ignition	1959-62	45077B/E	MA6

TRIUMPH 250 c.c. 'Tigress' (TW2) Scooter (6 volt) 1959-62—continued

Unit	Year	Part No.	Model
Contact breaker			
Cover	1959-62	47583B	4CA
Grommet	1959-62	54440136	4CA
Horn	1959	54190045	4CA
	1959	70151A	5H
	1960-62	70155A	5H
	1962	70169A	8H
Horn push and dip switch	1959-62	31563A/D	25SA
LAMPS			
Head			
Home and Export	1959	51519B	MCF575P
	Later	58417A/D	MCF575P
Export Europe (not France)	1959-62	58418A/D	MCF575P
Export France	1959-62	58419A/D	MCF575PEF
Export U.S.A.	1959-62	58420A/B	MCF575P
Stop tail and number plate	1959-62	53432B	564
Rectifier	1959-60	*47111A (47132)	FSW1501A
	Later	47132B	FSX1849
Suppressor	1959-62	78106A	WS5
Switches			
Ignition	1959-62	54033027	63SA
Knob	—	54331351	—
Ignition	1962	34427A	88SA
Lighting	1959-62	54033028	63SA
	1962	34289A	88SA
Knob	—	54331482	—
Stop lamp	1959-62	*31437B (54033234)	22B
Warning light	1959-62	38198B	WL3

TRIUMPH 250 c.c. 'Tigress' (TW2S) Scooter (12 volt, electric starting) 1959-62

Alternator			
Rotor	1959-62	54210946	5AF
Stator	1959-62	47135A/B	5AF
Battery	1959-62	—	MLZ9E
Cable harness	1959-62	54941657	—
Coil, ignition	1959-62	45101A	MA12
Contact breaker	1959-62	47583B	4CA
Cover	1959-62	54440136	—
Grommet	1959-62	54190045	—
Horn	1959	70152A	5H
	1960-62	70156A	5H
	1962	70164A	8H
Horn push and dip switch	1959-62	31563A/D	25SA
LAMPS			
Head			
Home and Export	1959	58382A	MCF575P
	Later	58421A/D	MCF575P
Export Europe (not France)	1959-62	58422A/D	MCF575P
Export France	1959-62	58423A/D	MCF575PEF
Export U.S.A.	1959-62	58424A/B	MCF575P
Stop tail and number plate	1959-62	53434B	564
Rectifier	1959-62	47128B	FSX1850
Starting motor	1959-62	*26501A, E (54025006)	M3
Suppressor	1959-62	78106A	WS5
Switches			
Ignition	1959-62	54033027	63SA
Knob	—	54331351	—
Ignition	1962	34427A	88SA
Lighting	1959-62	54033028	63SA
	1962	34289A	88SA
Knob	—	54331482	—
Starting motor	1959-62	76463A	48A
Stop lamp	1959-62	*31437B (54033234)	22B

TRIUMPH 350 c.c. o.h.v. 'Twenty-one' (3TA) 1958-62 and 500 c.c. o.h.v. 'Speed Twin' (5TA) 1959-62

Alternator			
Rotor	1958-61	423506	RM13
Stator	1958-61	468973	RM13
Rotor	1962	54213901	RM19
Stator	1962	47164A	RM19
Ammeter	1958-62	*36189A/B (36129)	BM4
Battery	1958-62	—	PUZ7E-11
Cable harness	1958-60	794981	—
	1961-62	54947272	—
Coil, ignition	1958-62	45077B/E	MA6
Distributor			
3TA	1958-62	40573E/H	18D2
5TA	1959-62	40646B	18D2
Horn	1958	70148A	HF1441
	1959-61	70048J	HF1441
	1962	70163A	8H
Horn push and dip switch	1958-62	31563A/D	25SA

* When ordering, quote part number shown in brackets



TRIUMPH 350 c.c. o.h.v. 'Twenty-one' (3TA) 1958-62 and 500 c.c. o.h.v. 'Speed Twin' (5TA) 1959-62—continued

Unit	Year	Part No.	Model	
LAMPS				
Head				
Home	1958-62	51860B	MCF700P	
Export Europe (not France)	1958-62	51757D	MCF700P	
Export France	1958-62	51758B	MCF700PEF	
Export U.S.A.	1958-62	51756E	F700P	
Stop tail and number plate	1958-62	53432B	564	
Rectifier	1958-59	*47111A (47132)	FSW1501A	
	Later	1959-62	47132B	FSX1849
Switches				
Lighting and ignition	1958-61	*31460A (31443)	PRS8	
	1962	31443E	PRS8	
Knob	1958-62	318346	—	
Stop lamp	1958-60	31688A	6SA	
	1961-62	34381A	6SA	

TRIUMPH 500 c.c. o.h.v. (TR5A-C) 1961 and 'Tiger' (T100SC) 1962

Unit	Year	Part No.	Model
Alternator			
Rotor	1961	54211596	RM13
Stator	1961	47165	RM15
Rotor	1962	54214272	RM19
Stator	1962	47173	RM19
Cable harness	1961-62	54947955	—
Coil, ignition	1961-62	45112D	2ET
Condenser	1961-62	54441582A	ET
Distributor	1961	40710B	18D2
	1962	40820A	18D2
Horn	1961-62	70145D	HF1930
Horn push	1961-62	76204D	4A
LAMPS			
Head			
Export	1961-62	58395A/B	MCH66
Stop tail and number plate	1961-62	53432B	564
Switches			
Cutout, ignition	1961-62	76204D	4A
Dipper (part of headlamp)	1961-62	31620B/E	PS9
Lighting (part of headlamp)	1961-62	*31276A/B (31356)	PS6
Stop lamp	1961-62	34381A	6SA

TRIUMPH 500 c.c. o.h.v. 'Tiger' (T100) 1958-59 600 c.c. 'Tiger' (T110) 1958 650 c.c. (T110) and 'Bonneville' (T120) 1959

Ammeter	1958-59	*36189A/B (36129)	BM4
Auto-advance unit	1958-59	47502B	—
Battery	1958-59	—	PUZ7E-10
Cable harness	1958-59	838321	—
Control box	1958-59	*37225E (37256)	RB108
Generator	1958-59	20035A	E3L
Horn	1958-59	70048F/J	HF1441
Horn push and dip switch	1958-59	31563A	25SA
LAMPS			
Head			
Home	1958-59	51860B	MCF700P
Export Europe (not France)	1958-59	51757D	MCF700P
Export France	1958-59	51758B	MCF700PEF
Export U.S.A.	1958-59	51756E	MCF700P
Stop tail and number plate	1958-59	53432B	564
Magneto	1958-59	42298B/D	K2F
(alternative)	1958-59	42324A/B	K2FR
(Export U.S.A.)	1958-59	42344B/E	K2F
Switches			
Cutout, magneto	1958-59	*31376A/B (31107)	SS5
Lighting and ignition	1958-59	31371D	RS39
Stop lamp	1958-59	31383B	22B

TRIUMPH 500 c.c. o.h.v. (TR5A-R) 1961 and 'Tiger' (T100SS) 1962

Alternator (E.T. condition)				
Rotor	1961	54211596	RM15	
Stator	1961	47149	RM15	
Alternator				
Rotor	1961	54211596	RM15	
Stator	1961	468973	RM15	
Rotor	1962	54213901	RM19	
Stator	1962	47164A	RM19	
Ammeter (part of headlamp)	1961	36084F	CZU27	
	1962	36296A	2AR	
Battery	1961-62	—	MLZ9E	
Cable harness (E.T. condition)				
	1961	54948030	—	
	1961	54948927	—	
	1962	54943001	—	
	Later	1962	54931223	—
Coil, ignition (E.T. condition)	1961	45112D	2ET	
	1961-62	45077E	MA6	
Condenser (E.T. condition)	1961	54441582A	ET	
Distributor (E.T. condition)	1961	40710B	18D2	
	1961-62	40646B	18D2	
Horn	1961	70155B	5H	
	1962	70163A	8H	
Horn push	1961	76204D	4A	
Horn push and dip switch	1962	31563D	25SA	
LAMPS				
Head				
Home and Export	1961	58556A	SS700P	
	1962	58878A	SS700P	
	Later	1962	58934A	SS700P
Stop tail and number plate	1961-62	53432B	564	
Rectifier	1961-62	47132B	FSX1849	
Switches				
Cutout, ignition (E.T. condition)	1961	76204D	4A	
Dipper	1961	*31549B (31482)	99	
Lighting (E.T. condition)	1961	31784A/D	4ISA	
Escutcheon plate	1961	318942A	—	
Lighting and ignition	1961	*31460A (31443)	PRS8	
	1962	31443E	PRS8	
Knob	—	318346	—	
Escutcheon plate	—	351803	—	
Stop lamp	1961-62	34381A	6SA	

TRIUMPH 500 c.c. o.h.v. 'Tiger' (T100A) 1960-61

Alternator (E.T. condition)				
Rotor	1960-61	54211596	RM15	
Stator	1960-61	47149A	RM15	
Alternator				
Rotor	1961	54211596	RM15	
Stator	1961	468973	RM15	
Ammeter	1960-61	*36189A/B (36129)	BM4	
Battery	1960-61	—	PUZ7E-11	
Cable harness (E.T. condition)				
	1960-61	54945038	—	
	1961	54947272	—	
	Later	1961	54948258	—
Coil, ignition (E.T. condition)	1960-61	45112B	2ET	
	1961	45077E	MA6	
Condenser (E.T. condition)	1961	54441582A	ET	
Distributor (E.T. condition)	1960-61	40710A	18D2	
	1961	40646B	18D2	
Horn	1960-61	70048J	HF1441	
Horn push and dip switch	1960-61	31563D	25SA	
LAMPS				
Head				
Home	1960-61	51860B	MCF700P	
Export Europe (not France)	1960-61	51757D	MCF700P	
Export France	1960-61	51758B	MCF700PEF	
Export U.S.A.	1960-61	51756E	MCF700P	
Stop tail and number plate	1960-61	53432B	564	
Rectifier	1960-61	47132B	FSX1849	
Switches				
Cutout, ignition (E.T. condition)	1960-61	*31376A (31107)	SS5	
Lighting (E.T. condition)	1960-61	31784A/D	4ISA	
Lighting and ignition	1961	*31460A (31443)	PRS8	
Knob	1961	318346	—	
Stop lamp	1960	31688A	6SA	
	1961	34381A	6SA	

TRIUMPH 500 c.c. o.h.v. 'Trophy' (TR5) and 650 c.c. 'Trophy' (TR6) 1958-59

Ammeter (part of headlamp)	1958-59	36084F	CZU27	
Auto-advance unit	1958-59	47502B	—	
Battery	1958-59	—	PUZ7E-10	
Cable harness	1958-59	831200	—	
Control box	1958-59	*37225E (37256)	RB108	
Generator	1958-59	20035A	E3L	
Horn	1958-59	70048F/J	HF1441	
Horn push and dip switch	1958-59	31563A	25SA	
LAMPS				
Head				
Home	1958-59	51892A	SSU700P	
Stop tail and number plate	1958-59	53432B	564	
Magneto	1958-59	42350A/H	K2FC	
(Export U.S.A.)	1958-59	42368A/BD	K2FC	
Switches				
Cutout, magneto	1958-59	76210A	4A	
Lighting (part of headlamp)	1958-59	31340A	U39	
ditto	Later	1959	31315A	U39
Stop lamp	1958-59	31383B	22B	

* When ordering, quote part number shown in brackets



TRIUMPH 500 c.c. o.h.v. 'Speed Twin' (5TAC) 1958 650 c.c. o.h.v. 'Thunderbird' (6TAC) 1958 and (6T) 1959-62

Unit	Year	Part No.	Model
Alternator			
Rotor	1958	466230	RM14
Stator	1958	*468677 (466168)	RM14
Rotor	1959-61	423506	RM15
Stator	1959-61	469427	RM15
Rotor	1962	54213901	RM19
Stator	1962	47164A	RM19
Ammeter	1958-62	*36189A (36129)	BM4
Battery	1958-59	—	PUZ7E-10
	1960-62	—	MLZ9E
Cable harness	1958-59	838601	—
	1960-61	54945033	—
	1961	54948259	—
	1962	54943002	—
Coil, ignition	1958-60	45077B/E	MA6
Distributor (5TAC)	1958	40352E	DKX2A
	1958-59	40449A/B	DKX2A
	1960-62	40690B	18D2
Horn	1958-61	70048J	HF1441
	1962	70163A	8H
Horn push and dip switch	1958-62	31563A/D	35SA
LAMPS			
Head			
Home and Export	1958-62	51860B	SS700P
Export Europe (not France)	1958-62	51757D	SS700P
Export France	1958-62	51758B	SS700PEF
Export U.S.A.	1958-62	51756E	SS700P
Stop tail and number plate	1958-62	53432B	564
Rectifier	1958-59	*47111A (47132)	FSX1850A
	Later	47132B	FSX1849
Switches			
Lighting and ignition	1958	31443E	PRS8
Knob	1958	318346	—
Lighting and ignition	1959	31371D	RS39
	1960-61	*31460A (31443)	PRS8
	1962	31443E	PRS8
Knob	1960-62	318346	—
Escutcheon plate	1961-62	351803	—
Stop lamp	1958-59	31383B	22B
	1960	31688A	6SA
	1961-62	34381A	6SA

TRIUMPH 650 c.c. o.h.v. 'Tiger' (T110) 1960-61, 'Trophy' (TR6 and TR6SS) and 'Bonneville' (T120) 1960-62

Alternator			
Rotor	1960	423506	RM13
Stator	1960	47134A	RM15
Rotor	1961	423506	RM13
Stator	1961	47178	RM15
Rotor	1962	54213901	RM19
Stator	1962	47162A	RM19
Rotor (Export U.S.A.)	1961	423506	RM13
Stator	1961	47171A	RM15
Rotor	1962	54213901	RM19
Stator	1962	47183A	RM19
Ammeter	1960-61	*36189A (36129)	BM4
	1962	36296A	2AR
Battery (T110)	1960-61	—	MLZ9E
	1960-62	—	PUZ7E-10
Cable harness (T110)	1960-61	54945036	—
	1960-61	54944995	—
	1962	54943000	—
	1962	54931221	—
	Later	54931590	—
Horn	1960-61	70048J	HF1441
	1962	70163A	8H
Horn push (TR6 and T120)	1960-61	76210A	4A
Horn push and dip switch			
T110	1960-61	31563D	35SA
TR6 and T120	1962	31563D	35SA
LAMPS			
Head			
Home (T110)	1960-61	51860B	MCF700P
Home and Export (TR6 and T120)	1960-61	58556A	SS700P
ditto	1962	58900A	SS700P
ditto	1962	58934A	SS700P
Export Europe (not France) (T110)	1960-61	51757D	MCF700P
Export France (T110)	1960-61	51758B	MCF700PEF
Export U.S.A. (T110)	1960-61	51756E	MCF700P
Stop tail and number plate	1960-62	53432B	564

TRIUMPH 650 c.c. o.h.v. 'Tiger' (T110) 1960-61, 'Trophy' (TR6 and TR6SS) and 'Bonneville' (T120) 1960-62—continued

Unit	Year	Part No.	Model
Magneto			
T110 and T120	1960	42344E	K2F
TR6	1960	42298D	K2F
All models	1961-62	42344E	K2F
Manual advance (Export U.S.A.)	1960-61	42350H	K2FC
Auto-advance (Export U.S.A.)	1960-62	42368D	K2FC
Auto-advance unit	1960-62	47502B	—
Rectifier	1960-62	47132B	FSX1849
Switches			
Cutout, magneto (T110)	1960-61	*31376A/B (31107)	SS5
	1960-62	76210A	4A
Lighting	1960-61	31784A/B	41SA
Escutcheon plate	—	318942A	—
Lighting	1962	34289A	88SA
Knob	1962	54330934	—
Stop lamp	1960	31688A	6SA
	1961-62	34381A	6SA

VELOCETTE 250 c.c. Twin 2-stroke 'Viceroy' Scooter 1960-62

Alternator			
Rotor	1960-62	423506	RM15
Stator	1960-62	47134A	RM15
Rotor	1962	54213901	RM19
Stator	1962	47162A	RM19
Ammeter	1960-62	36084A/F	CZU27
Battery (2 off)	1960-62	—	MLZ9E
Cable harness	1960-62	54946452	—
	Later	54949954	—
Coil, ignition (2 off)	1960-62	45077A/E	MA6
Contact breaker	1960-62	47591B	JCA
Flasher unit	1962	35020A	FL5
Grommet	1962	199002	—
Horn	1960-62	70141A/B	HF1849
	1962	70164A	8H
Horn push and dip switch	1960-62	31563A/D	35SA
LAMPS			
Flasher	1962	53977A	628
Head			
Home	1960-62	58627A/D	MCF575A
Stop tail and number plate	1960-62	53454B	564
Rectifier	1960-62	47128A	FSX1850
Starting motor	1960-62	26504A	M3
Switches			
Flasher	1962	31823A	52SA
Ignition	1960-62	54033027	63SA
Knob	—	54331351	—
Ignition	Later	34427A	88SA
Cover	—	54336178	—
Lighting	1960-62	54033028	63SA
Knob	—	54331482	—
Lighting	Later	34289A	88SA
Knob	—	54330935	—
Starting motor	1960-62	*76463A (76442)	4SA
Stop lamp	1960-62	31383A	22B
Warning light, flasher	1962	38192A	WL15
Bulb holder	—	54945043	—
Bulb	—	281	—

VELOCETTE 350 c.c. o.h.v. 'Viper' 1958-62 350 c.c. 'MAC' 1958-61 500 c.c. o.h.v. 'Venom' and 'MSS' 1958-62

Magneto	1958-62	42133F/H	K1F
Auto-advance unit	1958-62	47576A	—
'Venom' and 'Viper'	1958-62	47545B	—
Tank badge (serviced by Veloce)	1961-62	54850133	—

VELOCETTE 350 c.c. o.h.v. and 500 c.c. o.h.v. 'Scrambler' 1958-62

Magneto	1958-62	42346A/B	K1FC
Tank badge (serviced by Veloce)	1961-62	54850133	—

* When ordering, quote part number shown in brackets

AMMETERS

Model Interpretation

The symbols making up the model indicate the characteristics of each ammeter, i.e., BM4—base, moulded, round, approximately 2" diameter, voltage control circuits, damped movement.

BM	Base moulded.	CZ	Centre zero.
4	Round, approx. 2" diameter; voltage control circuits; damped movement.	U	Universal movement.
		27	Round, 1½" diameter; 8 amp.
	2AR New design for high-speed machines.		

DETAILED SPARE PARTS

Part No.	36084A/F	36129D/F	36184B	*36189A/B (36129) BM4	*36220A (36184) CZU27	36296A 2AR
Model	CZU27	BM4	CZU27			
§Ring, ammeter sealing	523986	369201	523986	—	523986	—
§Nut, terminal	166043	—	166043	—	166043	166043
§Washer, terminal	185040	—	185040	—	185040	185040
§Screw, terminal	—	121610	—	121610	—	—
Bulb holder	—	—	365421	—	365421	—
§Bulb	—	—	998	—	998	—

BATTERIES

Model Interpretation

LV5E	Lightweight.	†RU7E	General purposes; anti-vibration.
†PU5E	Lightweight.	†GU11E	Sidecar use.
†PU7E	General purposes.	†SC7E	High capacity for special purposes.
	†MK9E Medium capacity battery: ultra lightweight.		

Prefix number (as in PU5E), i.e., 5 = number of plates per cell.

Suffix number (as in PU5E/10), i.e., /4 = Fixed leads.

/9 = Outside terminal; three separate lids.

/10 = Outside terminal; one-piece lid.

/11 = Inside terminal; one-piece lid.

† All the above batteries (except LV5E) are available dry charged.
When ordering insert 'Z' before numeral of type required, e.g., PUZ5E.



BATTERIES

BATTERY SPECIFICATIONS

Type	Volts	Ampere Hours		Dimensions in inches		
		10 hours	20 hours	Length	Width	Height
GUZ11E	6	20.0	22.8	7 $\frac{1}{2}$ "	3 $\frac{3}{8}$ "	6 $\frac{1}{2}$ "
†LV5E	6	5.0	5.7	3 $\frac{11}{16}$ "	3 $\frac{11}{16}$ "	5"
MKZ9E	6	7.0	8.0	6 $\frac{1}{2}$ "	1 $\frac{1}{2}$ "	5"
†PUZ5E	6	8.0	10.0	3 $\frac{11}{16}$ "	3 $\frac{11}{16}$ "	6 $\frac{1}{16}$ "
PUZ5E/10	6	8.0	10.0	4 $\frac{11}{16}$ "	3 $\frac{11}{16}$ "	6 $\frac{1}{16}$ "
PUZ5E/11	6	8.0	10.0	3 $\frac{11}{16}$ "	3 $\frac{11}{16}$ "	6 $\frac{1}{16}$ "
†PUZ7E/4	6	12.0	13.5	4 $\frac{11}{16}$ "	3 $\frac{11}{16}$ "	6 $\frac{1}{16}$ "
PUZ7E/9	6	12.0	13.5	4 $\frac{11}{16}$ "	3 $\frac{11}{16}$ "	6 $\frac{1}{16}$ "
PUZ7E/10	6	12.0	13.5	4 $\frac{11}{16}$ "	3 $\frac{11}{16}$ "	6 $\frac{1}{16}$ "
PUZ7E/11	6	12.0	13.5	4 $\frac{11}{16}$ "	3 $\frac{11}{16}$ "	6 $\frac{1}{16}$ "
†RUZ7E	6	12.0	13.5	6 $\frac{1}{2}$ "	3 $\frac{11}{16}$ "	6 $\frac{1}{16}$ "
SCZ7E	6	22.5	26.0	4 $\frac{11}{16}$ "	3 $\frac{1}{8}$ "	7"
MLZ9E	6	12.0	13.0	4 $\frac{11}{16}$ "	2 $\frac{1}{8}$ "	5 $\frac{1}{8}$ "
MKZ5E	6	7.0	8.0	4 $\frac{11}{16}$ "	1 $\frac{11}{16}$ "	5"

† This battery has fixed leads

MODEL GUZ11E

Particularly suitable for combination machines, this high-capacity motor cycle battery embodies the very latest Lucas developments in battery construction. It has "linkless" type connectors—this method of inter-cell connection, apart from saving weight, offers a much neater and cleaner appearance. The terminals, too, are an outstanding feature—they are of a special design to give a positive, easily removable connection, free from corrosion nuisance. The bared cable is passed through a tapered collet which is pulled by a moulded knurled screw into the taper of the burnt-on terminal. Filler caps are of the latest unspillable design: acid cannot be lost even if the battery is overturned. Attractive case, polished finish, moulded in "Milam" with shock-proof cover. This battery was originally designed to satisfy stringent police requirements and has now been adopted for universal use.

MODEL LV5E

A real "pocket-size" battery for the lightweight machine. This extra small model is specially intended for use on machines where heavy current consumption is not normally encountered and where a saving in space and weight is essential.

MODEL PUZ7E/9

- OUTSIDE — DETACHABLE — SOCKETED — NON-CORRODIBLE CABLE CONNECTORS
- CUSHIONED LID MOUNTING AND PLATE SUPPORTING BASES
- NON-SPILL — DRY CELL TOPS — LOWER SELF-DISCHARGE

This "King of the Road" battery has been specially designed for the motor cyclist, to give a longer life of efficiency under the most arduous conditions.

Outstanding among the many new features is the new Lucas cell pack construction which, with micro-porous pack separation and protective rubber vents, eliminates ACID spilling and ensures DRY, CLEAN CELL TOPS.

MODEL RUZ7E

This is the well-known "Anti-vibration" battery which has its fixings *anchored in rubber*. It has the same capacity as the PUZ7E and the same general characteristics; but in addition it embodies a patent built-in shock absorbing suspension device which effectively damps out the more severe road shocks and engine vibration. The cover, with its shock-proof rubber cushions, is held by two strong snap clips and can be removed instantly without disturbing the fixing bracket. The ideal battery for the hard-riding motor cyclist.

MODEL PUZ5E/10

A battery for the standard lightweight machine. This model follows conventional design, but has fixed leads. The cell construction incorporates micro-porous and woven glass pack separators.

MODEL SCZ7E

A new addition to the range of Lucas motor cycle batteries, the SCZ7E is designed for special purposes and is of high capacity. The case is of translucent material and enables the acid level to be seen from the outside. Other features include anti-spill filler caps, nut and bolt type terminals, and a container top free from inter-cell connectors.

MODEL MKZ9E-2

This is an ultra-lightweight battery of entirely new design. It has been designed primarily for motor scooters, its small size and weight being the obvious advantage. This battery is constructed of white translucent material, enabling the acid level to be seen from the outside and giving it an extremely pleasing appearance.

MODEL MLZ9E

Small, compact and light in weight, this new design of motor cycle and scooter battery has a blue plastic cover which automatically seals the anti-spill vent plugs in a common venting chamber. Gas leaving the vent plugs can be ducted away by means of a polythene tube, allowing the fumes to escape without causing corrosive damage.

BATTERY FILLER

Ordering No. 24189603

Correct topping up is automatically ensured with the Lucas Battery Filler: It cannot overflow and may even be used in the dark. Automatic topping up is the perfect battery safeguard, and a boon to every motor cyclist. The valve is opened by pressing the Filler nozzle downwards on to the separators. Distilled water flows into the cell until the electrolyte is level with the tops of the separators, when the flow automatically ceases. On removal of the Filler, the valve closes, preventing leakage from the nozzle.

Guarantee

LUCAS MOTOR CYCLE BATTERIES

All usual and reasonable precautions have been taken to ensure excellence of materials and workmanship, and in the event of any defect which is not caused by wear and tear, misuse, accident, or negligence, being disclosed within twelve months of its being put into use, we will either supply new parts or components in exchange for those defective, or repair such defective parts or components free of charge. We do not undertake to dismantle or reassemble, or bear the cost of dismantling or reassembling any such part or component on the machine. This undertaking shall be deemed to exclude any and every other obligation whatsoever, and all liability for any loss or damage, howsoever or whensoever caused or arising, except the cost of replacement or repair in accordance with this undertaking.



BATTERIES

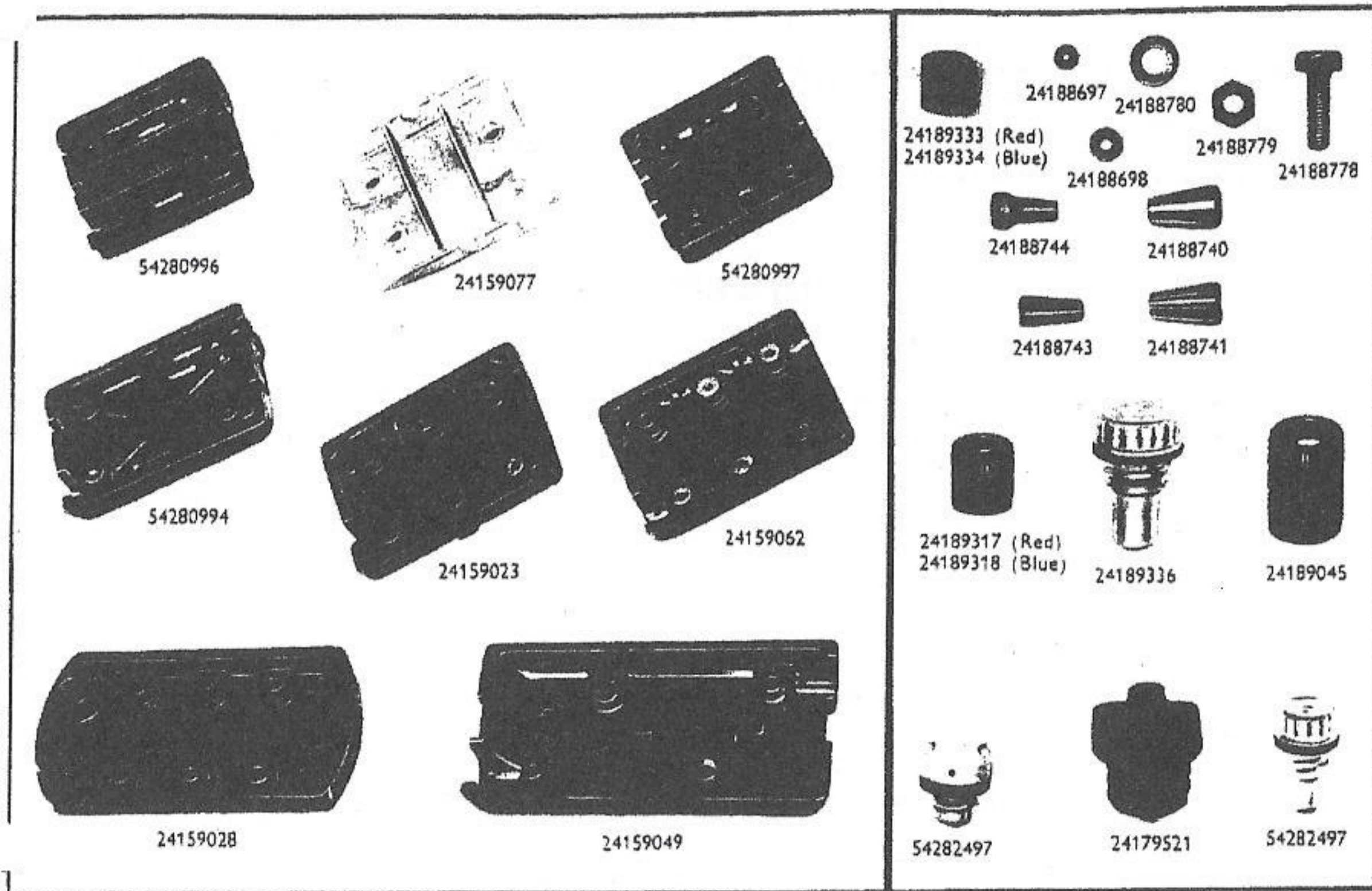

BATTERY SUNDRIES

NOTE: RUZ7E, PUZ7E/4, LV5E and PUZ5E batteries have fixed leads, and terminal spare parts are not, therefore, available for service.

	PUZ5E	PUZ5E/10 and PUZ5E/11	LV5E	RUZ7E	PUZ7E/4	PUZ7E/9	PUZ7E/10 and PUZ7E/11	GUZ11E	SCZ7E	MKZ9E
Cover	54280997	54280996	24159040	24159028	24159023	24159062	54280994	24159049	24159077	—
Vent plug (with rubber washers where applicable)	54282497	54282497	54282497	24183604	24183604	24179521	24179521	24189336	24189336	54282497
Washer, cable, positive ..	—	24188697	—	—	—	—	24188697	—	—	24188697
Washer, cable, negative ..	—	24188698	—	—	—	—	24188698	—	—	24188698
Collet, tapered, positive ..	—	—	—	—	—	24188743	—	24188740	—	—
Collet, tapered, negative ..	—	—	—	—	—	24188744	—	24188741	—	—
Nut, bakelite, black ..	—	—	—	—	—	—	—	†24189045	—	—
Nut, bakelite, red, positive	—	24189333	—	—	—	24189317	24189333	—	—	24189333
Nut, bakelite, blue, negative	—	24189334	—	—	—	24189318	24189334	—	—	24189334
Bolt, terminal	—	—	—	—	—	—	—	—	†24188778	—
Nut, terminal	—	—	—	—	—	—	—	—	†24188779	—
Washer, terminal	—	—	—	—	—	—	—	—	†24188780	—

For battery dimensions, see page B2.

† Suitable for either positive or negative terminals

CABLES



HIGH TENSION CABLES

Lucas H.T. cables consist of high conductivity tinned copper wire, insulated with vulcanised rubber overall. Outer covering is of neoprene, rubber or highly polished yellow and black braided cotton. P.V.C. cables sheathed overall with one or two layers of P.V.C. compound. For the very best results we recommend neoprene covered cable, which has been specially ozone tested and is resistant to heat, petrol and water. Neoprene, P.V.C. and high gloss cables conform to British Standards Specification 1862.

NEOPRENE

This superior grade high tension cable to Specification UM837 is ozone tested, insulated with neoprene, and is resistant to heat, ozone, petrol and water. We recommend this cable to give excellent service under all conditions.

Core size	Overall diameter of cable	Part No. 12 yd. Spool	Part No. 100 ft. Spool	Approx. American Brown and Sharpe gauge
19/.012	7 mm.	857158	857159	15

HIGH GLOSS

High conductivity tinned copper wires insulated with vulcanised rubber with outer covering of highly polished yellow and black braided cotton.

Core size	Overall diameter of cable	Part No. 12 yd. Spool	Part No. 100 ft. Spool	Approx. American Brown and Sharpe gauge
19/.012	7 mm.	841601	841602	15

P.V.C.

P.V.C. sheathed overall with P.V.C. compound. Suitable for scooters and mopeds, etc.

Core size	Overall diameter of cable	Part No. 100 ft. Spool	Colour	Approx. American Brown and Sharpe gauge
9/.012	5 mm.	54930013	Black	17

P.V.C.

High conductivity tinned copper wires, P.V.C. sheathed overall with one or two layers of P.V.C. compound. Supplied in nine attractive, popular colours: red, black, blue, green, white, yellow, purple, grey and orange.

Core size	Overall diameter of cable	Approx. American Brown and Sharpe gauge	Colour	Part No. 12 yd. Spools	Part No. 100 ft. Spools
16/.012	7 mm.	15	Red	842010	842011
16/.012	7 mm.	15	Black	842012	842013
16/.012	7 mm.	15	Blue	842014	842015
16/.012	7 mm.	15	Green	842016	842017
16/.012	7 mm.	15	White	842018	842019
16/.012	7 mm.	15	Yellow	842020	842021
16/.012	7 mm.	15	Purple	842022	842023
16/.012	7 mm.	15	Grey	842024	842025
16/.012	7 mm.	15	Orange	842026	842027

CABLES

P.T. P.V.C. (PLASTIC) INSULATING GENERAL PURPOSE CABLE

High conductivity copper conductor, insulated overall with P.V.C. Radial thickness .030". Impervious to petrol, oils, diluted acids or tropical fungi. Available in extensive range of self colours with or without a contrasting tracer extruded through to the conductor. Cable conforms to British Standards Specification 1862 (where applicable).

Conductor size	Approx. American Brown and Sharpe gauge	Carrying capacity (amps.)	Conductor size	Approx. American Brown and Sharpe gauge	Carrying capacity (amps.)
Single 14/.010	19	6	Twin 28/.012	2 x 14	17.5
Twin 14/.010	2 x 19	6	Triple 40/36	3 x 16	10

Colour	Part No. (100ft. Spools) 14/.010	Colour	Part No. (100 ft. Spools) 14/.010
Green	841610	Blue/Brown	841662
Purple	841611	White/Black	841670
Red	841612	Green/Yellow	841672
Blue	841613	Brown/Blue	841687
Yellow	841614	Brown/Green	841690
White	841615	Red/Black	841698
Black	841616	Black/White	841919
Brown	841617		

P.V.C. (PLASTIC) TWIN AND TRIPLE CORE CABLES

Cores	Core size	Colour	Application	Part No. (100 ft. Spools)
2 (flat)	14/.010	Black	General	54941180
2 (flat)	14/.010	Red	General	54941181
2 (flat)	28/.012	Green	General	54941182
2 (flat)	28/.012	Black	General	54941183
3	40/36	Black	General	54941184
3	40/36	Grey	General	54941185
3	40/36	Brown	General	54941186

P.V.C. INSULATED MOTOR CYCLE CABLES

Specification: High conductivity copper conductor insulated overall with P.V.C. Impervious to petrol, oils, diluted acids or tropical fungi. Designed for motor cycle use where additional flexibility is required.

Conductor size	Colour	Part No. 100 ft. Spools	Approx. American Brown and Sharpe gauge	Carrying capacity (amps.)
36/36 (.0076)	Black	54941154	17	9
36/36 (.0076)	Red	54941155	17	9
36/36 (.0076)	Blue	54941156	17	9
36/36 (.0076)	Yellow	54941157	17	9
36/36 (.0076)	Green	54941158	17	9
36/36 (.0076)	White	54941159	17	9
36/36 (.0076)	Purple	54941160	17	9
36/36 (.0076)	Brown	54941161	17	9

RUBBER INSULATED MOTOR CYCLE CABLES

Specification: Conductors of stranded tinned copper wire insulated with high grade vulcanised rubber for motor cycle wiring. The cable conforms in all respects to British Standards Specification 7.

Conductor size	Overall diameter	Part No. 100 ft. Spools	Approx. American Brown and Sharpe gauge	Carrying capacity (amps.)
40/36 (.0076)	4 mm.	857141	16	10
40/36 (.0076)	5 mm.	857144	16	10

LUCAR SERVICE CONNECTORS



BLADES

Part No.	Amps.	Fixing Hole	Application
199218 Blade	17.5	4 B.A.	TPS1/1 Switches
199275 Blade	17.5	2 B.A.	CZU34 Ammeters
199279 Blade	17.5	2 B.A.	DM2 and DM6 Distributors
199317 Blade	35	2 B.A.	CZU34 Ammeters
54190000 Blade	17.5	1/8"	General Application
54190013 Blade	17.5	1/8"	ST950 Switches
54190014 Blade	35	1/8"	ST950 Switches

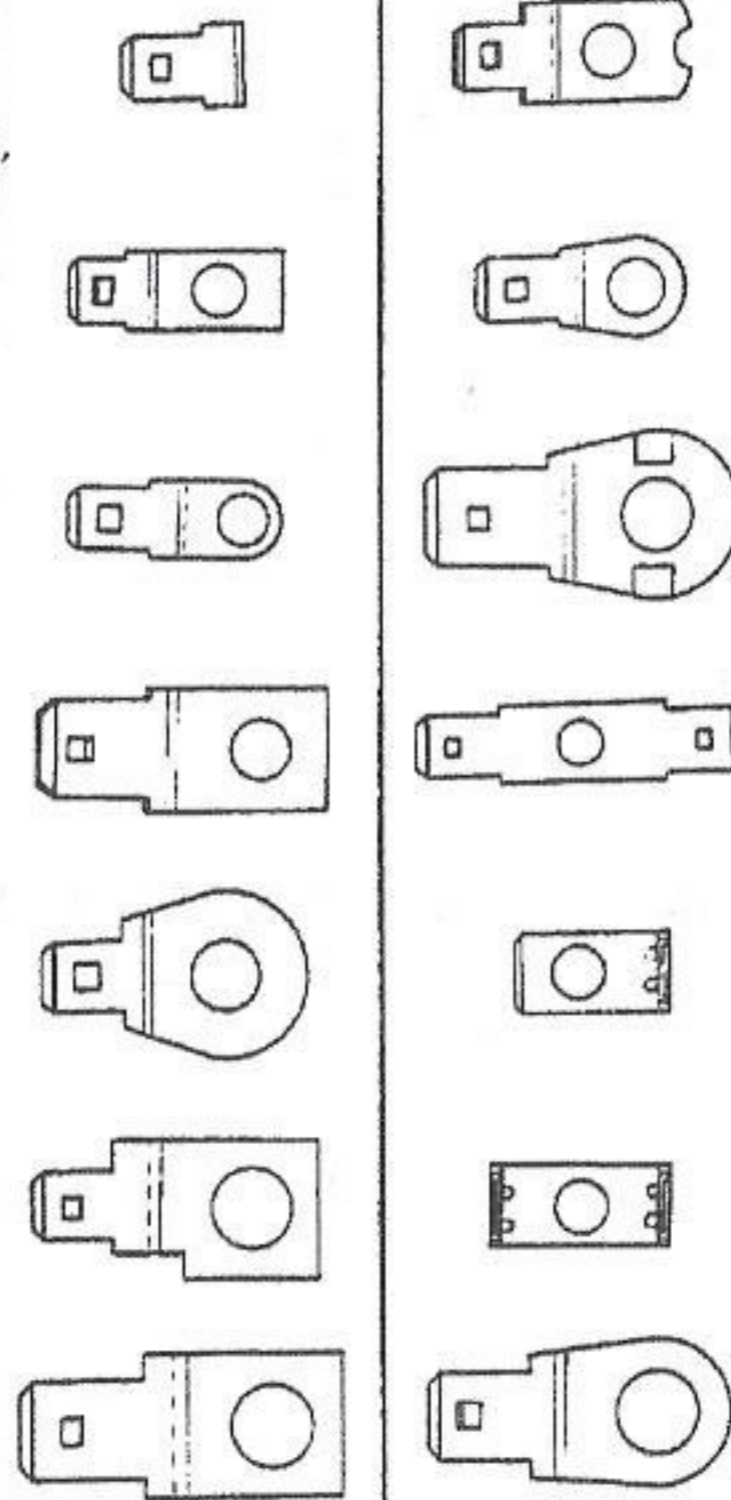

Part No.	Amps.	Fixing Hole	Application
54190015 Blade	17.5	2 B.A.	ST950 Switches
54190038 Blade	17.5	2 B.A.	C39PV-2F Generators
54190044 Blade	35	1/8"	C39PV-2D Generators
54190076 Blade	17.5	3 B.A.	Earthing Connector (double contact)
54190096 Blade	17.5	2 B.A.	LA12 & HA12 Ignition Coils
54190108 Blade	17.5	2 B.A.	LA12 Ignition Coils
54199524 Blade	17.5	1/8"	Earthing Connectors

FEMALE CONNECTORS

54942078 Female	17.5	Single Leads only
54942079 Female	35	Double or Single Leads
54942747 Female	17.5	Double Lead Connector

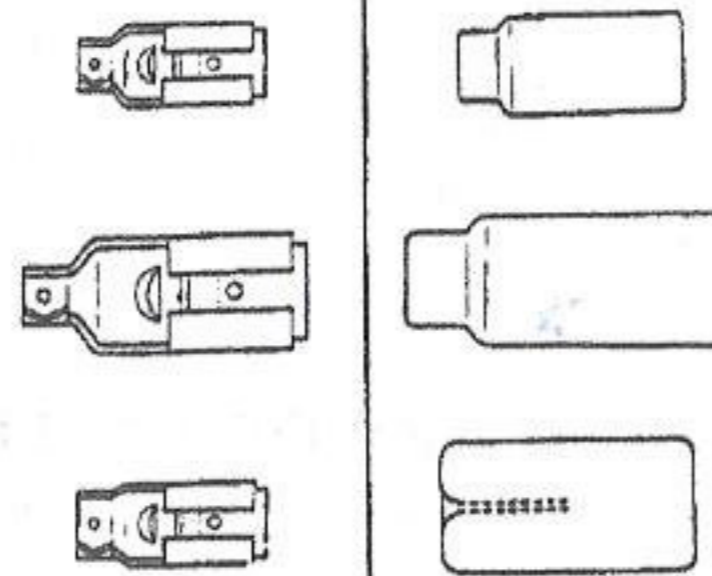

54190042 Insulating Cover	Used with Female Connector 54942078
54190043 Insulating Cover	Used with Female Connector 54942079
54190119 Insulating Cover	Used with Female Connector 54942747

54944898
Inhibitor
(Insulating Cover and
Female Connector)

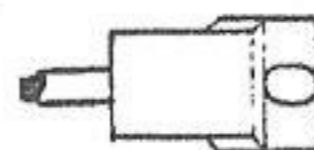

Made up with 4" of
cable and a Female
Connector to fit on
to the field terminal
of the Control Box



BATTERIES AND AMMETERS



MODEL MLZ9E



MODEL 2AR
36296

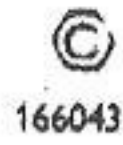

166043



185040

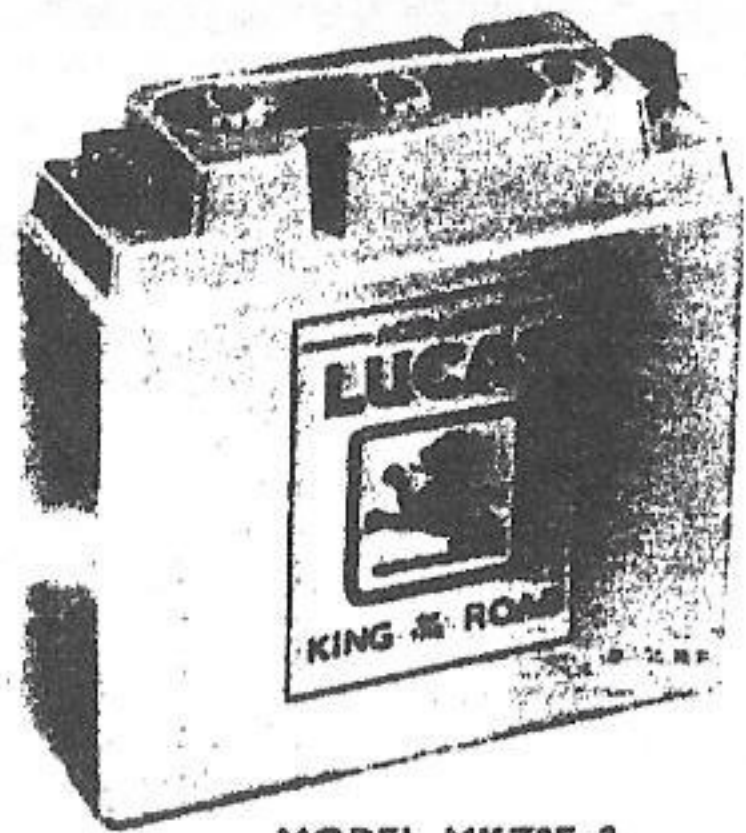

MODEL MKZ9E-2

LUCAS

C

Model Interpretation

MC Motor cycle. 2 LRT9/2 Regulator. 108 Regulator box with 106/2 Regulator incorporating thermostat for temperature compensation; terminal sleeve connections.
 R Regulator. RB Regulator box.

DETAILED SPARE PARTS

Part No. Model	37097E MCR2	37144A MCR2	37144B MCR2	37144D MCR2	37221K RB108	37225E RB108	37225F/J RB108
§Cover	226363	391454	226363	226363	54381655	54381654	54381654
§Clip, cover fixing	226364	391453	226364	226364	—	—	—
Gasket, cover	—	—	—	—	226289	226212	226289
Washer, plain	—	—	—	—	137060	—	—
Washer, spring	—	—	—	—	185061	—	—
Nut, fixing	—	—	—	—	156654	—	—
Rivet	—	—	—	—	—	189781	—
§Regulator	—	33141A	—	—	—	—	—
§Contact, set regulator	226339	391346	226339	226339	226339	226339	226339
§Contact set, cutout	335767	391347	335767	335767	335767	335767	335767
Screw, adjusting	54380161	390794	390794	54380161	54380161	390794	54380161
Nut or spring, adjusting screw	54380088	390529	390529	54380088	54380088	390529	54380088
Screw, regulator fixing	—	100384	—	—	—	—	—
Washer, regulator fixing screw	—	185038	—	—	—	—	—
Bracket or plate, clamping	390387	390387	390387	390387	336454	336454	336454
Screw, fixing plate	132504	132504	132504	132504	126544	126544	126544
Washer, plate fixing screw	—	—	—	—	185040	185040	185040

Part No. Model	37228E/F RB108	37288H/J RB108	37232H/K RB108	37252A RB108	37252B/E RB108
§Cover	54381655	54381655	54381655	54381656	54381656
Gasket, cover	226212	226289	226289	226212	226289
Washer, plain	137060	137060	137060	—	—
Washer, spring	185061	185061	185061	—	—
Nut, fixing	156654	156654	156654	—	—
Rivet	189781	—	—	189781	—
§Contact set, regulator	226339	226339	226339	226339	226339
§Contact set, cutout	335767	335767	335767	335767	335767
Screw, adjusting	390794	54380161	54380161	390794	54380161
Nut or spring, adjusting screw	390529	54380088	54380088	390529	54380088
Bracket or plate, clamping	336454	336454	336454	336454	336454
Screw, fixing plate	126544	126544	126544	126544	126544
Washer, plate fixing screw	185040	185040	185040	185040	185040

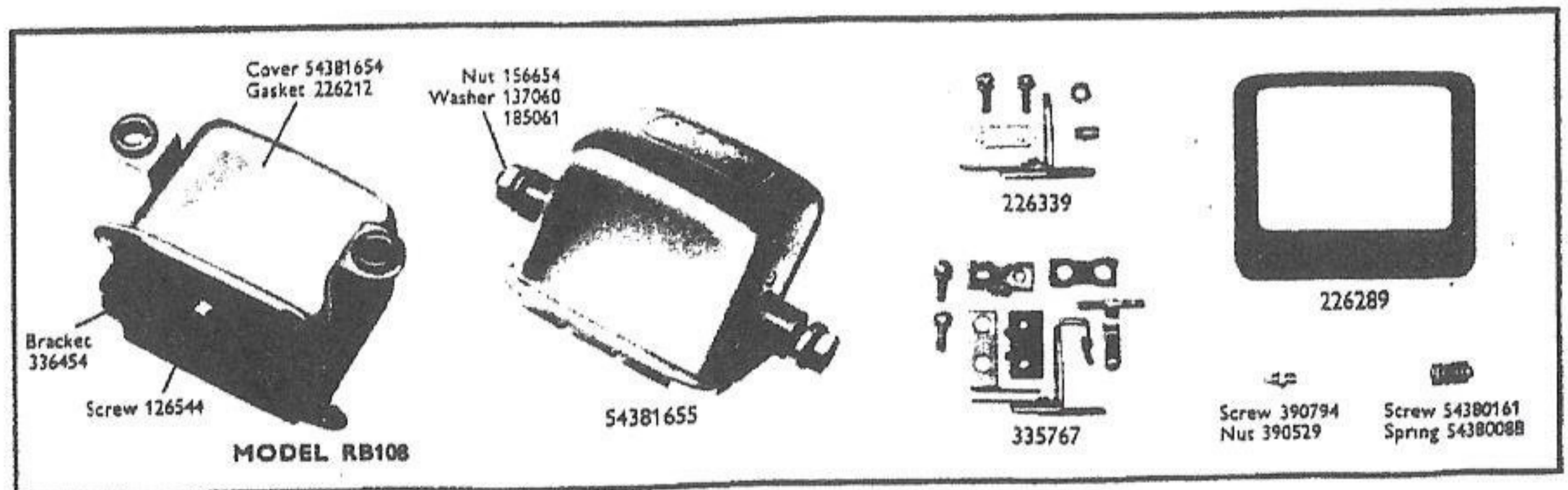

§ Recommended spares for stock

GENERATORS Model Interpretation

Prefix		Suffix	
E	Eccentrically mounted armature.	D	Distributor mounted.
M	Motor cycle.	L	Long type yoke; voltage control.
3	3" diameter yoke.	M	Magneto mounted.
35	3.5" diameter yoke.	N	Voltage control; bearing both ends.
		S	Short type yoke.

DETAILED SPARE PARTS

Part No.	*20010K E3L (20036)	20034A/B E3LM	20035A E3L	20036A E3L	20038B E3N	22011A C35SD
Model						
Replaced by						
§Cover band	200609	—	—	—	—	4
Screw, cover band fixing	127584	—	—	—	—	—
Nut, cover band fixing screw	169160	—	—	—	—	—
Ring, rubber, cover seating	—	—	—	—	—	220480
§Brushes, set	200737	200737	200737	200737	200737	220383
§Bracket or frame, commutator end Cover	200713	200713/S	200713/S	200713/S	200713/S	220566
Spring, commutator end	—	—	—	—	—	220593
§Bearing, commutator end	189210	189210	189210	189210	189210	220569
Washer, felt, bearing	200708	200708	200708	200708	200708	189285
Cup, felt, bearing washer	200709	200709	200709	200709	200709	—
§Insulating plate, with brush boxes	200738	200911	200911	200911	200911	220572
§ Springs, set, brush tension	220197	220197	220197	220197	220197	220197
Ring, sealing, rubber	—	369201	369201	369201	369201	—
§Cover assembly, commutator end	200826	200923	200924	200924	200924	—
Grommet, cable	—	200895	200895	200895	200895	—
Terminal pin	200229	—	—	—	—	—
Plate, clamping terminal	200829	200908	200908	200908	200908	—
§Bearing, drive end	189307	189307	189307	189307	189307	189307
§Bracket or frame assembly, drive end Plate, bearing	200382	200912	200760	200382	200805	220556
Oil seal or thrower	—	200262	200748	—	200799	220516
Washer, oil excluding, leather	200378	—	188614	200378	—	188618
Washer, oil retaining, langite	200379	—	—	200379	—	—
Screw, generator to magneto	200380	—	—	200380	—	—
Nut, shaft	—	123063	—	—	—	—
Washer, shaft nut	170104	—	—	—	—	180396
§Gear, driving	140074	—	—	—	—	188350
Screw, end, gear retaining	—	454495	—	—	—	220643
Nut, bearing retaining	—	111704	111704	111704	—	—
§Armature	200224	200224	—	170109	200800	—
§Field coils, set	200752	200754	200712	200752	200802	220575
§Bolt, through fixing	200731	200731	200731	200731	200188	220487
§Sundry parts, set	200732	200732	200732	200732	200227	220475
	200806	200806	200806	200806	200806	220557

ROTORS (ALTERNATOR)

Part No.	Model	Details	Replaced by	Part No.	Model	Details	Replaced by
423506	RM15	0.751" bore	—	54210946	5AF	Special bore	—
466124	RM13	Special bore	—	54212005	RM18	0.606" bore—less keepers	54213900
466125	RM13	0.752" bore	—	54212288	RM19	1.001" bore—less keepers	54213905
466230	RM14	Special bore	—	54212457	RM18	0.967" bore—less keepers	54213904
466233	RM13	0.751" bore	—	54212537	RM20	1.001" bore—less keepers	54213906
54210413	RM13	0.752" bore—less keepers	466125	54213901	RM19	0.751" bore	—
54210937	RM20	0.752" bore—less keepers	54213902	54213903	RM18	0.751" bore	—
54210940	5AF	Special bore	—	54214031	9AF	0.758" bore	—

* When ordering, quote part number shown in brackets § Recommended spares for stock



STATORS, ALTERNATOR AND RECTIFIERS

STATORS (ALTERNATOR)

DETAILED SPARE PARTS

Part No.	47122A	47134A	47135A/B	47136A/B	47137A	*47138B	*47141A	*47143A	47149A
Model	RM15	RM13	5AF	5AF	RM13	RM13	RM13	RM13	RM15
Replaced by	—	—	—	—	—	(47175)	(47176)	(47177)	—
Clip, cable	54211509	54210167	—	—	54210167	54210167	54210167	54210167	—
Washer, cable clip	131023	131023	—	—	131023	131023	131023	131023	—

Part No.	47154A	47161A	47162A	47164A	47165A	47171A	47173A/B	47174A	47175A	47176A
Model	RM15	RM18	RM19	RM19	RM13/15	RM13/15	RM19	9AF	RM13	RM13
Clip, cable	54211509	54213907	54210167	54210167	—	54210167	54210167	—	54210167	54210167
Washer, cable clip	131023	131023	131023	131023	—	131023	131023	—	131023	131023

Part No.	47177A	47178A	47181A	47182A	47183A	466168	*468677	468678	468973	469427
Model	RM13	RM13/15	RM19	RM19	RM19	RM14	RM14	RM13/15	RM13/15	RM15
Replaced by	—	—	—	—	—	—	(466168)	—	—	—
Pad, insulating	—	—	—	—	—	465918	465918	—	—	—
Clip, cable	54210167	54210167	54210167	54210167	54210167	465717	465717	54210167	—	54211509
Screw, cable clip	—	—	—	—	—	—	—	—	—	—
Washer, fixing	—	—	—	—	—	186092	186092	—	—	—
Washer, fixing	—	—	—	—	—	—	—	—	—	—
Washer, fixing	—	—	—	—	—	128013	128013	—	—	—
Washer, fixing	—	—	—	—	—	—	—	—	—	—
Washer, cable clip	131023	131023	131023	131023	131023	—	—	131023	—	131023

RECTIFIERS

Part No.	*47111A/B	47128B	47132B
Model	FSW1501A	FSX1750A	FSX1849
Replaced by	(47132)	—	—
Shroud, protection	—	54480662	54480662

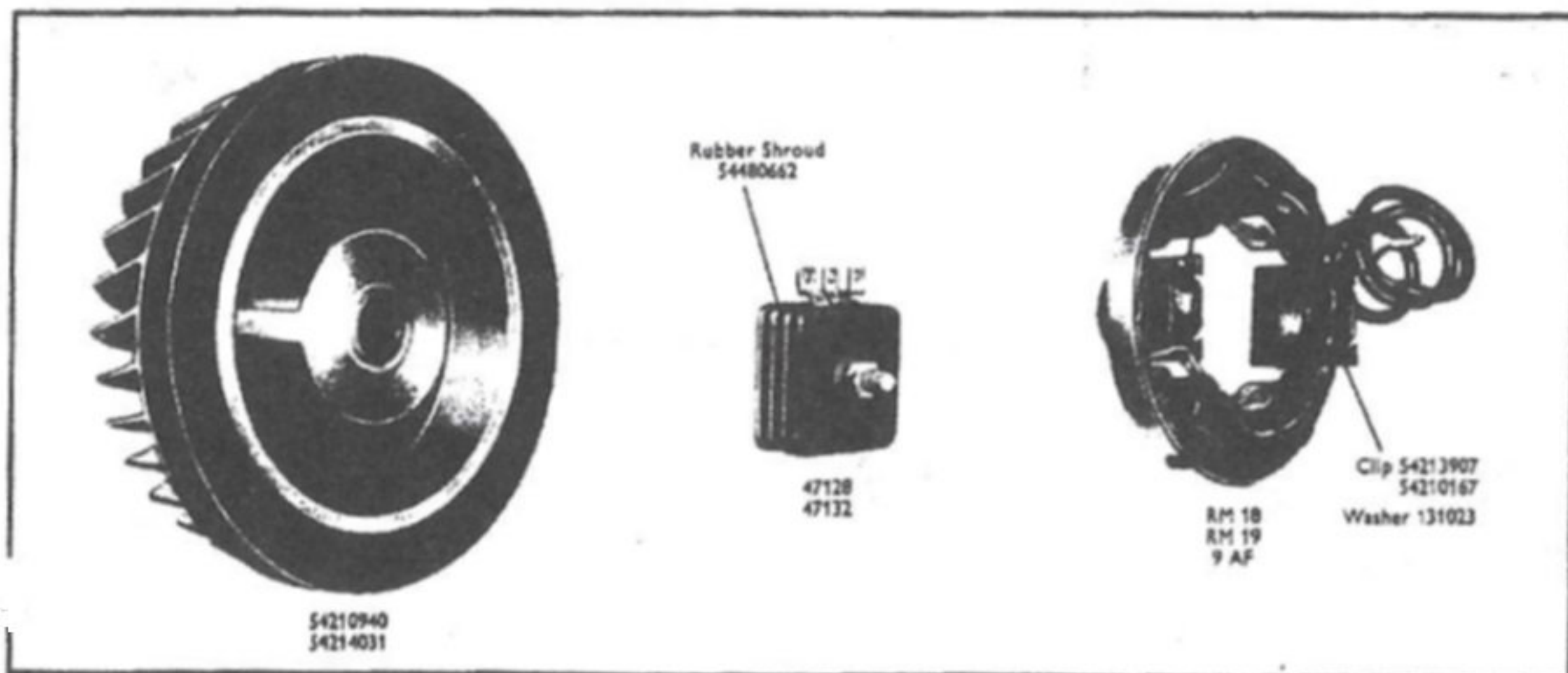

* When ordering, quote part number shown in brackets

§ Recommended spares for stock

Model Interpretation

HF High frequency.

1234 Black and chromium plated finish.
4½" diameter.

1235 All black finish. 4½" diameter.

1441 Fitted with black tone disc nut and screw type terminals.

1849 Black body and tone disc. Chromium plated rim.

1950 Lightweight. For alternating current models.

DETAILED SPARE PARTS

Part No.	*70037E (54068036)	*70039J (54068034)	70048A/F —	70048H/J —	*70106A (54068034)	*70136A (70048)
Replaced by	HF1235	HF1234	HF1441	HF1441	HF1234	HF1441
Model	Black	Black and C.P.	Black	Black	Poly-chromatic Silver	Black
Finish						
Tone disc	703339	703339	701829	701829	703339	701829
Nut, tone disc, domed	178931	178931	178931	178931	178931	178931
Nut, tone disc, locking	—	—	703106	—	—	703106
§Armature and/or diaphragm	703988	703988	700714	700714	703988	700714
Nut, diaphragm locking	184000	184000	—	184000	184000	184000
Washer, packing, cover and/or diaphragm	700238	700238	—	—	700238	—
§Bracket	—	—	701851	701851	—	701851
Screw, cover and bracket fixing	141666	145481	—	—	145481	—
Screw, cover fixing	144500	145491	—	—	145491	—
§Contact set	703233	703233	703233	703233	703233	703233
Terminal block	703004	703004	703004	703004	703004	703004
§Sundry parts, set	703235	703235	703235	703235	703235	703235

Part No.	*70137A (70048)	70140A	70141A/B	70142A/D	70145A/D	*70146A/B (70142)	*70147A/B (70151)	*70148A (70048)
Replaced by	HF1441	HF1441	HF1849	HF1849	HF1950	HF1849	HF1849	HF1441
Model	Black	Black	Zinc Plate	Black and C.P.	Bright	Black	Green	Black
Finish								
Tone disc	701829	701829	705108	705108	—	705108	705108	701829
Nut, tone disc, domed	178931	178931	—	705114	—	—	—	178931
Nut, tone disc, locking	703106	703106	—	—	—	165498	165498	703106
§Armature and/or diaphragm	700714	700714	—	—	—	—	—	700714
Nut, diaphragm locking	184000	184000	—	—	—	—	—	184000
Cover	—	—	705085	705085	—	705085	705085	—
§Bracket	701851	700776	—	—	—	—	—	701851
Screw, cover and bracket fixing	—	—	113030	113030	—	113030	113030	—
Ring, cover sealing	—	—	705068	705068	—	705068	705068	—
Support, cover	—	—	705086	705086	—	705086	705086	—
§Contact set	703233	703233	—	—	—	—	—	703233
Screw, adjusting	—	—	705098	705098	—	705098	705098	—
Nut, adjusting screw	—	—	165498	166032	—	—	—	—
Washer, adjusting screw	—	—	131674	131674	—	131023	131023	—
Terminal block	703004	703004	—	—	—	—	—	703004
§Screw, terminal	—	—	—	—	138453	—	—	—
§Sundry parts, set	703235	703235	—	—	—	—	—	703235

NOTE. Model 5H Horns (Part Numbers 70152, 70153, 70155 and 70156) have no serviceable spare parts.

* When ordering, quote part number shown in brackets

§ Recommended spares for stock



ELECTRIC HORNS

DETAILED SPARE PARTS

Part No. Replaced by Model Finish	70151A — HF1849 Green	*70157A (70142) HF1849 Black, grey and C.P.	70162A — HF1849 Black	70163A — 8H Silver Grey	70164A — 8H Silver Grey	70169A — 8H Silver Grey	*069239 (54068034) HF1234 Black and C.P.	*069424 (54068034) HF1234 Black and C.P.
Tone disc	705108	705108	705108	54680729	54680729	54680729	703339	703339
Nut, tone disc, domed	—	705114	—	54680727	54680727	54680727	178931	178931
Nut, tone disc, locking	165498	—	165498	—	—	—	—	—
§Armature and/or diaphragm	—	—	—	54681247	54681248	54681247	703988	703988
Nut, diaphragm locking	—	—	—	—	—	—	184000	184000
Washer, packing, cover and/or diaphragm	—	—	—	54680732	54680732	54680732	700238	700238
Cover	705085	705085	705085	—	—	—	—	—
§Bracket	—	—	—	54680850	54680850	54680850	700168	703185
Screw, cover and bracket fixing	113030	113030	113030	—	—	—	145481	145481
Screw, cover fixing	—	—	—	—	—	—	145491	145491
Ring, cover sealing	705068	705068	705068	—	—	—	—	—
Support, cover	705086	705086	705086	—	—	—	—	—
§Contact set	—	—	—	—	—	—	703233	703233
Screw, adjusting	705098	705098	705098	—	—	—	—	—
Nut, adjusting screw	—	166032	—	—	—	—	—	—
Washer, adjusting screw	131023	131674	131023	—	—	—	—	—
Terminal block	—	—	—	—	—	—	703004	703004
Rim	—	—	—	54680731	54680731	54680731	—	—
§Sundry parts, set	—	—	—	54681085	54681085	54681085	703235	703235

No. Replaced by Model Finish	*069446 (54068034) HF1234 Black and C.P.	*069468 (54068034) HF1234 Poly- chromatic Silver	*069482 (54068034) HF1234 Poly- chromatic Silver	*069483 (54068034) HF1234 Poly- chromatic Silver	*069498 (54068034) HF1234 Black and C.P.	*069508 (54068036) HF1234 Black	54068034 — HF1234 Black and C.P.	54068036 — HF1234 Black
Tone disc	703339	703339	703339	703339	703339	703339	703339	703339
Nut, tone disc, domed	178931	178931	178931	178931	178931	178931	178931	178931
§Armature and/or diaphragm	703988	703988	703988	703988	703988	703988	703988	703988
Nut, diaphragm locking	184000	184000	184000	184000	184000	184000	184000	184000
Washer, packing, cover and/or diaphragm	700238	700238	700238	700238	700238	700238	700238	700238
§Bracket	701686	701686	703349	700168	700168	700168	701686	703396
Screw, cover and bracket fixing	145481	145481	145481	145481	145481	141666	145481	141666
Screw, cover fixing	145491	145491	145491	145491	145491	144500	145491	144500
§Contact set	703233	703233	703233	703233	703233	703233	703233	703233
Terminal block	703004	703004	703004	703004	703004	703004	703004	703004
§Sundry parts, set	703235	703235	703235	703235	703235	703235	703235	703235

NOTE. Model 5H Horns (Part Numbers 70152, 70153, 70155 and 70156) have no serviceable spare parts.

HORN BRACKETS

Part No.	Horn Models	Horn to Bracket		Bracket to Mounting		Part No.	Horn Models	Horn to Bracket		Bracket to Mounting	
		Fixing hole diameter	Fixing hole centres	Fixing hole diameter	Fixing hole centres			Fixing hole diameter	Fixing hole centres	Fixing hole diameter	Fixing hole centres
700168	HF1234/5	.266"	4.00"	.406"	—	703185	HF1234	.234"	4.000"	.516"	—
70776	HF1441	.390"	—	.265"	1.25"	703349	HF1234	.266"	4.000"	.406"	—
701686	HF1234/5	.266"	4.00"	.406"	—	703396	HF1235	.266"	4.000"	.312"	1.000"
†701851	HF1441	.390"	—	.191"	1.25"	54680850	8H	.156"	2.218"	.196"	0.625"

* When ordering, quote part number shown in brackets
C.P. ... Chromium plated

† Ordering Number covers a single lamination

§ Recommended spares for stock

ELECTRIC HORNS



The following selection of electric horns are suitable for application to all types of motor cycles and scooters

MODEL 5H — Bright anodised finish

6 volt				12 volt			
Part No.	70155A	Part No.	70156A

MODEL 6H — Polychromatic grey finish

6 volt				12 volt			
Part No.	54068060	Part No.	54068061
			Part No.				Part No.
Horn	70174A	Horn	70175A
No serviceable parts				No serviceable parts			
Foot, flat	54681363	Foot, flat	54681363
Foot, right angled	54681364	Foot, right angled	54681364
Bolt	142725	Bolt	142725
§Washer, spring	185051	§Washer, spring	185051
§Connector, Lucar	†54942078	§Connector, Lucar	†54942078
§Sleeve, Lucar	†54190042	§Sleeve, Lucar	†54190042

MODEL 8H — Silver grey finish

6 volt				12 volt			
Part No.	54068028	Part No.	54068029
			Part No.				Part No.
§Horn	70163A/B	§Horn	70164A/B
§ Bracket	54680850	§ Bracket	54680850
Nut, tone disc	54680727	Nut, tone disc	54680727
Tone disc	54680729	Tone disc	54680729
Washer, diaphragm packing	54680732	Washer, diaphragm packing	54680732
Diaphragm and armature	54681247	Diaphragm and armature	54681248
Rim	54680731	Rim	54680731
§ Sundry parts, set	54681085	§ Sundry parts, set	54681085
Cable	54931110	Cable	54931110
Connector, Lucar	†54942078	Connector, Lucar	†54942078
Sleeve, insulating	†54190042	Sleeve, insulating	†54190042

MODEL 9H — Ebony black finish

6 volt High note				12 volt High note			
Part No.	54068017	Part No.	54068008
			Part No.				Part No.
Screw, fixing bracket	111950	Screw, fixing bracket	111950
Washer, fixing bracket screw	185081	Washer, fixing bracket screw	185081
Contact set	54680903	Contact set	54680903
Washer, diaphragm packing	54680620	Washer, diaphragm packing	54680620
Diaphragm	54680993	Diaphragm	54680900
§ Sundry parts, set	54680902	§ Sundry parts, set	54680902
§ Bracket	54680686	§ Bracket	54680686

6 volt Low note				12 volt Low note			
Part No.	54068016	Part No.	54068009
			Part No.				Part No.
Screw, bracket fixing	111950	Screw, bracket fixing	111950
Washer, bracket fixing screw	185081	Washer, bracket fixing screw	185081
Contact set	54680903	Contact set	54680903
Washer, diaphragm packing	54680620	Washer, diaphragm packing	54680620
Diaphragm	54680994	Diaphragm	54680901
§ Sundry parts, set	54680902	§ Sundry parts, set	54680902
§ Bracket	54680686	§ Bracket	54680686

For illustrations, see page E4.

† For details and illustrations, see page B7.

§ Recommended spares for stock



ELECTRIC HORNS

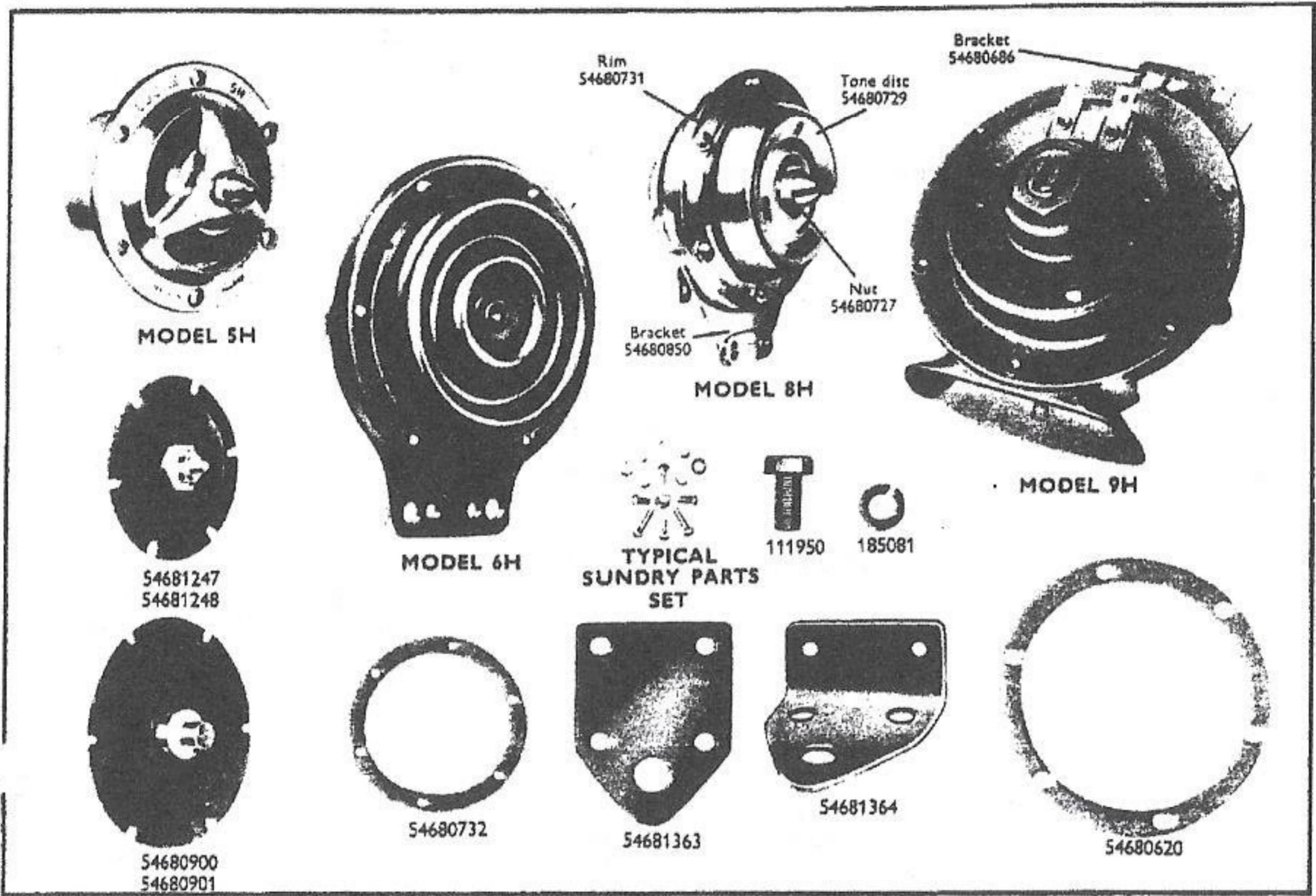

CONTENTS

	<i>Description</i>	<i>Page</i>
Coils		
Detailed parts		F3
Contact Breaker Units		
Detailed parts		F2
Distributors		
Detailed parts		F4-5
Magdynos		
Detailed parts		
Model MO1L		F11
Magnetos		
Detailed parts		
Models K1F, K2F and N14		F7-8
Competition Models KNRI, K2FR, K1FC, NC1, KNC1 and K2FC		F9-10
Models SR1 and SR2		F6
Magneto		
Auto-advance units		
Detailed parts		F6
Flywheel magnetos		
Detailed parts		F6
Suppressors		
Descriptive reference		F3
Starting Motors		
Detailed parts		F3



CONTACT BREAKER UNITS AND DISTRIBUTORS

Model Interpretation

Prefix

- A Fitted with automatic advance and retard mechanism.
- CA Combined contact breaker and auto-advance mechanism.
- D Distributor.
- D1 Short flange-mounted distributor.
- K Small cast iron body with moulded contact breaker base and die-cast auto-advance weights.

Prefix

- X Hardened steel auto-advance mechanism.
- 15 Miniature single cylinder type.
- 18 Miniature twin cylinder type.

Suffix

- 1 Suitable for single cylinder engines.
- 2 Suitable for twin cylinder engines.
- 4 Suitable for four cylinder engines.
- A Fitted with automatic advance and retard mechanism.

CONTACT BREAKER UNITS

DETAILED SPARE PARTS

Part No. Replaced by Model	*47568D/E (47572) CA1A	47571A/E — CA1A	47572A/D — CA1A	47574F — 3CA	47578E/H — CA1A	47579A/D — CA1A
Support, lubricator, felt	—	—	—	—	425833	—
Screw or bolt, fixing	—	—	—	126881	126504	126504
Washer, spring, screw fixing	—	—	—	—	185040	185040
Plate	465958	465958	465958	—	465958	465958
Nut, terminal or fixing	166094	166094	166094	166094	166094	166094
Washer, plain, terminal	131023	131023	131023	—	131023	131023
Washer, insulating, terminal	161353	161353	161353	161353	161353	161353
Bush, insulating, terminal or lever	419950	419950	419950	419950	419950	419950
Contact set	420196	420196	420196	423153	420196	420196
Condenser	54413002	54413002	54413002	424670	54413002	54413002
Cam	465939	465939	465939	468993	465939	465939
Ring, jump, fixing screw retaining	—	—	—	54410896	—	—
Screw, cam fixing	—	—	—	54100434	—	—
Felt, cam lubricating	—	—	—	425251	425251	—
Plate, contact breaker base	—	—	—	468631	—	—
Springs, set, auto-advance	424971/S	421457/S	424971	—	425298/S	416136/S
Toggle	407131	407131	407131	—	407131	407131
Weight	415729	415730	415729	—	415729	415729
Sleeve and action plate assembly	465932	469107	465932	—	425733	425733

Part No. Replaced by Model	47579E/H — CA1A	*47580D/E (425379) 4CC	47583A/B — 4CA	47591A/B — 3CA	47595A — CA1A
Support, lubricator, felt	425833	—	—	—	425833
Screw or bolt, fixing	126504	—	—	145904	126504
Washer, spring, screw fixing	185040	—	—	—	185040
Plate	465958	425382	425382	468631	465958
Circlip, mechanism retaining	—	—	—	466040	—
Nut, terminal or fixing	166094	169194	169194	—	166094
Washer, plain, terminal	131023	—	—	—	131023
Washer, insulating, terminal	161353	—	—	161353	161353
Bush, insulating, terminal or lever	419950	—	—	419950	419950
Contact set	420196	54410078	54410078	423153	420196
Condenser	54413002	425377	425377	424670	54413002
Cam	465939	—	54440029	466166	465939
Felt, lubricating, cam	425251	425378	425378	—	425251
Plate, contact breaker base	—	425370	425370	—	—
Springs, set, auto-advance	416136/S	—	54413020	54413522	425298/S
Toggle	407131	—	—	—	407131
Weight	415729	—	54440031	496005	415729
Sleeve and action plate assembly	425733	—	54440032	466026	54414514

* When ordering, quote part number shown in brackets

§ Recommended spares for stock

H.T. COILS, STARTING MOTORS AND SUPPRESSORS



H.T. COILS DETAILED SPARE PARTS

Part No. Model	45077A/E MA6	45101A MA12
§Grommet, rubber	421554	421554
§Clip, cable contact	421863	421863
Nut, switch and contact breaker terminals	166043	166043
Washer, shakeproof, terminal	188330	188330
Washer, plain, terminal	131023	131023

NOTE. Part No. 45112B/D, Model 2ET, has no serviceable spare parts.

STARTING MOTORS DETAILED SPARE PARTS

Part No. Model Replaced by	*26501A/E M3 (54025006)	26504A M3 —	54025006 M3 —
§Bolt, through fixing	54250291	54250291	54250291
§Brushes, set	54250595	54250595	54250595
§Bracket or frame, commutator end	54252306	54252306	54252306
§ Bushing, bearing	261233	261233	261233
Washer, brake	54252305	54252305	54252305
Plate, steel brake	54250427	54250427	54250427
§Plate, with brush holders and springs	54250751	54250751	54250751
§ Springs, set, brush tension	54250596	54250596	54250596
Cover, rubber, waterproofing lever	54250509	54250509	54250509
Bolts, bearing, lever fixing	253131	253131	253131
Spring, return, lever	54250763	54250763	54250763
§Shoe, operating lever	253070	253070	253070
Lever and peg	54250275	54251629	54250275
§Drive	54250294	54250294	54250294
Bushing, pinion	54250355	54250355	54250355
Bush, drive operating	54250639	54250639	54250639
Spring, cushioning	54250241	54250241	54250241
Ring, locking	291655	291655	291655
§Bracket, fixing	54250271	54250271	54250271
Bushing, drive end bracket	54250347	54250347	54250347
Washer, cup, armature locating	54250141	54250141	54250141
§Circlip, armature locating	261084	261084	261084
§Armature	54250289	54250289	54250289
§Coils, field, set	54250753	54250753	54250753
Terminal, field	54250479	54250479	54250479
§Sundry parts, set	54251434	54251434	54251434
§Switch	—	—	76442
Nut, terminal	—	—	172580
Washer, spring, terminal nut	—	—	185053

SUPPRESSORS

Part No.	Model	Application	Description
78105	WS5	Distributor suppressor	For use in ignition high tension supply.
78106	WS5	Sparking plug suppressor	Clip-on fixing; right angled.
78118	WS11	Sparking plug suppressor	Waterproof cover; right angled.
78119	WS5	Magneto suppressor	4,000/6,000 ohms resistance.
78120	WS5	Magneto suppressor	4,000/6,000 ohms resistance.
78134*	WS5	Magneto suppressor	Similar to 78106; 5,000 ohms resistance.

* When ordering, quote part number shown in brackets

§ Recommended spares for stock



DISTRIBUTORS

DETAILED SPARE PARTS

Part No.	40145E/F	*40352D/E (40449)	40426A	40449A/B	*40466A/B (40712)
Replaced by	—	(40449)	—	—	(40712)
Model	DKX1A	DKX2A	DKX4A	DKX2A	15D1
Rotation	Anti-clock	Anti-clock	Anti-clock	Anti-clock	Anti-clock
Range	16°-18°	13°-15°	14°-16°	11½°-13°	9°
(1) §Plate	405588	406105	417497	406105	406105
(2) Screw and nut	401119	401119	401092	401119	401119
(3) §Dog or gear	417198	—	220498	—	—
(4) Cup, thrust, sealing	—	—	—	—	—
(5) §Distributor, service	—	—	40426/S	—	—
(6) §Cover, distributor	402101	400136	400135	400136	421112
(7) Grommet, rubber, cover	—	—	—	—	—
(8) § Nut, moulded	—	410600	410600	410600	—
(9) Clip, cable, contact	—	—	—	—	—
(10) Brush and spring	—	404435	404435	404435	—
(11) Rotor arm	—	400052	400052	400052	—
(12) Contact breaker, complete	400164	400164	400164	400164	421106
(13) Condenser	400308	400308	400308	400308	421327
(14) Cover, rubber	—	—	—	—	—
(15) Connector	400034	400034	400034	400034	—
(16) Contact set	400415	400415	400415	400415	—
(17) Plate, contact breaker base	—	—	—	—	—
(18) Terminal	123022	123022	123022	123022	405314
(19) Base, contact breaker	400001	400001	400001	400001	—
(20) Bush, terminal insulating	—	—	—	—	421109
(21) Pad, insulating, contact spring	—	—	—	—	421102
(22) Connector, condenser to pillar	—	—	—	—	—
(23) Bush, insulating	—	—	—	—	—
(24) Cam	407932	415283	496085	415283	422659
(25) Springs, set, auto-advance	406699	421538/S	421625	421538/S	422655/S
(26) Weight, auto-advance	415730	415730	415730	415730	421056/S
(27) Toggles	407131	407131	407131	407131	—
(28) §Shaft and action plate	420409	421414	420691	421935	422584
(29) §Ring, rubber sealing	—	—	—	—	—
(30) Collar, shaft	—	—	—	—	422650
Oil seal	—	—	—	—	—
Bushing, top	—	—	420406	—	—
(33) Bushing, bottom	420406	420406	420406	420406	—
(34) Clip, cover securing	420261	420261	420261	420261	421561
(35) Sundry parts, set	400843	400843	400843	400843	419645

Part No.	40646A/B	40664A/B	40669A/B	40690A/B	40699A
Model	18D2	15D1	15D1	18D2	15D1
Rotation	Anti-clock	Clockwise	Clockwise	Anti-clock	Clockwise
Range	12°-15°	11°-13°	12°-14°	11°-13°	10½°-12½°
(1) §Plate	—	—	—	—	406105
(2) Screw and nut	—	—	—	—	401119
(3) Cup, thrust, sealing	424974	—	—	—	—
(4) §Cover, distributor	425049	421112	421112	425049	54411737
(5) Grommet, rubber, cover	421554	—	—	421554	—
(6) Clip, cable, contact	421863	—	—	421863	—
(7) § Brush and spring	404435	—	—	404435	—
(8) Bracket, cover	—	—	—	—	54411736
(9) Rotor arm	423486	—	—	423486	—
(10) Condenser	54410823	421327	421327	54410823	421327
(11) Cover, rubber	421569	—	—	421569	—
(12) Contact set	425219	421106	421106	425219	421106
(13) Plate, contact breaker base	423113	—	—	423113	—
(14) Terminal	123154	405314	405314	123154	405314
(15) Bush, terminal insulating	423110	421109	421109	423110	421109
(16) Pad, insulating, contact spring	—	421102	421102	—	421102
(17) Connector, condenser to pillar	423108	—	—	423108	—
(18) Bush, insulating	423109	—	—	423109	—
(19) Cam	424972	54411249	54412727	425284	423759
(20) §Springs, set, auto-advance	54410895	421415	54412018	425398	54412731
(21) §Weight, auto-advance	421056/S	421056/S	421056/S	421056/S	421056/S
(22) §Shaft and action plate	424967	421054	421054	425444	421054
(23) §Ring, rubber, sealing	188639	—	—	188639	—
(24) Collar, shaft	—	421103	421103	—	421103
Oil seal	—	54160003	—	—	54160003
Bushing, bottom	423571	—	—	425498	—
Clip, cover securing	424158	421561	421561	424158	†54120019
(28) §Sundry parts, set	425243	419645	54412407	425243	54412407

* When ordering, quote part number shown in brackets

† Screw

§ Recommended spares for stock

DISTRIBUTORS



DETAILED SPARE PARTS

*40486A (40426) DKX4A Anti-clock 14°-16°	*40529A/B (40699) 15D1 Clockwise 11½°	*40550A (40610) DKX2A Clockwise 11½°-13°	40573D/H — 18D2 Anti-clock 12°-15°	40589A/D — 18D2 Anti-clock 11°-13°	40599A — 18D1 Anti-clock 12°-15°	40610A — 18D2 Clockwise 11°-13°	*40621A/D (40701) 15D1 Clockwise 14°-16°	40628A/B — 18D1 Anti-clock 12°-15°	
417497	406105	406105	—	420151	420151	420151	—	420151	(1)
401092	401119	401119	—	415087	415087	415087	—	415087	(2)
220643	—	—	—	—	—	—	—	—	(3)
—	—	—	424974	—	—	—	—	—	(4)
—	—	—	—	—	—	—	—	—	(5)
400135	421112	400136	425049	425049	424151	425049	421112	424151	(6)
—	—	—	421554	421554	—	421554	—	—	(7)
410600	—	410600	—	—	—	—	—	—	(8)
—	—	—	421863	421863	—	421863	—	—	(9)
404435	—	404435	404435	404435	—	404435	—	—	(10)
400052	—	400051	423486	423486	—	423486	—	—	(11)
400164	—	400164	—	—	—	—	—	—	(12)
400308	421327	400308	54410823	54410823	54410823	54410823	421327	54410823	(13)
—	—	—	421569	421569	421569	421569	—	421569	(14)
400034	—	400034	—	—	—	—	—	—	(15)
400415	421106	400415	425219	425219	425219	425219	421106	425219	(16)
—	—	—	423113	423113	423113	423113	—	423113	(17)
123022	405314	123022	123154	123154	123154	123154	405314	123154	(18)
400001	—	400001	—	—	—	—	—	—	(19)
—	421109	—	423110	423110	423110	423110	421109	423110	(20)
—	421102	—	—	—	—	—	421102	—	(21)
—	—	—	423108	423108	423108	423108	—	423108	(22)
—	—	—	423109	423109	423109	423109	—	423109	(23)
496085	423759	422381	424972	425284	425746	425598	421047	425746	(24)
421625	54412731	416047/S	425398/S	54412732	425398	54412732	54412731	425398	(25)
415730	421056/S	415729	421056/S	421056/S	421056/S	421056/S	421056/S	421056	(26)
407131	—	407131	—	—	—	—	—	—	(27)
420691	421054	424123	424967	425444	425444	425596	421054	54410545	(28)
—	—	—	188639	188639	188639	—	—	—	(29)
—	421103	—	—	—	—	—	421103	422650	(30)
—	54160003	—	—	188643	—	—	—	—	(31)
—	—	—	—	—	—	—	—	—	(32)
420406	—	420406	—	—	—	—	—	—	(33)
420406	—	420406	423571	425498	423121	423121	—	423121	(33)
420261	421561	420261	424158	424158	424158	424158	421561	424158	(34)
400843	54412407	400843	425243	425243	425243	425243	419645	425243	(35)

40699B 15D1 Clockwise 10½°-12½°	40700A 15D1 Clockwise 13°	40700B 15D1 Clockwise 13°	40701A 15D1 Clockwise 14°-16°	40702A 15D1 Clockwise 12°-14°	40710A 18D2 Anti-clock 9°-11°	40710B 18D2 Anti-clock 9°-11°	40712A 15D1 Anti-clock 9°	40820A 18D2 Anti-clock 4°-6°	
—	406105	—	—	—	—	—	406105	—	(1)
—	401119	—	—	—	—	—	401119	—	(2)
54411737	54411737	54411737	54411737	54411737	424974	424974	—	424974	(3)
—	—	—	—	—	425049	425049	54411737	425049	(4)
—	—	—	—	—	421554	421554	—	421554	(5)
—	—	—	—	—	421863	421863	—	421863	(6)
—	—	—	—	—	404435	404435	—	404435	(7)
54411736	54411736	54411736	54411736	54411736	—	—	54411736	—	(8)
—	—	—	—	—	423486	423486	—	423486	(9)
421327	421327	421327	421327	421327	54410823	—	421327	—	(10)
—	—	—	—	—	421569	—	—	—	(11)
421106	421106	421106	421106	421106	425219	425219	421106	425219	(12)
—	—	—	—	—	423113	54410498	—	54410498	(13)
405314	405314	405314	405314	405314	123154	123154	405314	123154	(14)
421109	421109	421109	421109	421109	423110	423110	421109	423110	(15)
421102	421102	421102	421102	421102	—	—	421102	—	(16)
—	—	—	—	—	423108	—	—	—	(17)
—	—	—	—	—	423109	—	—	—	(18)
423759	54411249	54411249	421047	54412727	54412359	54412359	422659	54414381	(19)
54412731	421415	421415	54412731	54412018	422655/S	422655/S	422655	422655/S	(20)
421056/S	421056/S	421056/S	421056/S	421056/S	421056/S	421056/S	421056/S	421056/S	(21)
421054	421054	421054	421054	421054	424967	424967	422584	424967	(22)
—	—	—	—	—	188639	188639	—	188639	(23)
—	—	—	—	—	—	—	422650	—	(24)
421103	421103	421103	421103	421103	—	—	54160003	—	(25)
54160003	54160003	54160003	—	—	—	—	—	—	(26)
—	—	—	—	—	423571	423571	—	423571	(26)
†54120019	†54120019	†54120019	†54120019	†54120019	424158	424158	†54120019	424158	(27)
54412407	54412407	54412407	54412407	54412407	425243	425243	54412407	425243	(28)

* When ordering, quote part number shown in brackets

† Screw

‡ Recommended spares for stock



MAGNETOS

Model Interpretation

Prefix		Prefix	
K	Lightweight unit.	1	Single cylinder.
KN	45 mm. spindle height.	2	Twin cylinder.
KNR	Special version of 'KN' for racing.	V	V Twin.
N	35 mm. spindle height.	Suffix	
NC	Special version of 'N' magneto for competition purposes.	F	Flange mounting.
SR	Lightweight unit, rotating magnet type.	C	Competition type.
		R	Racing type.
		L	Used with 'KN1', 'KN2' and 'NI' Models where ring type cam is fitted.

MODELS SR1 AND SR2 DETAILED SPARE PARTS

Part No. Model Rotation Cutout Replaced by	42281A/D SR1 Mk. IIA Anti-clock Left hand	42281E SR1 Mk. IIA Anti-clock Left hand	*42330A/B SR1 Mk. II Anti-clock (42281)	*42330D SR1 Mk. II Anti-clock (42281)	42364A/D SR2 Mk. IIA Clockwise Left hand
§ Cover	54440529	54440529	54440529	54440529	54441424
§ Brush and spring	—	—	—	—	404433
§ Screw, cover fixing	144406	54101749	144406	54101749	144769
§ Screw, long, cover fixing	145389	—	145389	—	491168
§ Grommet, cover	—	54441256	—	54441256	—
§ Spring, contact	—	54441257	—	54441257	—
§ Gasket, rubberised cork	458194	458194	458194	458194	458194
§ Rotor arm	—	—	—	—	492979
§ Terminal, contact breaker	144426	144426	144426	144426	144426
§ Bush, insulating, contact breaker terminal	458028	458028	458028	458028	458028
§ Condenser	492342	492342	492342	492342	492342
§ Contact set	458053	458053	458053	458053	458053
§ Plate, contact breaker	490895	490895	490895	490895	491488
§ Cup, insulating, bearing	451378	451378	451378	451378	451378
§ Bearing, contact breaker end	189289	189289	189289	189289	189289
§ Shim, contact breaker plate packing, .003"	458044	458044	458044	458044	458044
§ Shim, contact breaker plate packing, .005"	458045	458045	458045	458045	458045
§ Shim, contact breaker plate packing, .010"	458046	458046	458046	458046	458046
§ Shaft	458020	458020	458020	458020	458021
§ Washer, shaft nut	170109	170109	170109	170109	170109
§ Rotor, magnetic	140074	140074	140079	140079	140074
§ Bearing, drive end	490859	490859	490859	490859	492147
§ Cup, insulating, bearing	189291	189291	189291	189291	189291
§ Seal, oil	451379	451379	451379	451379	451379
§ Coil, wound	459033	459033	459033	459033	459033
§ Screw, terminal	493805	493805	493805	493805	493805
§ Bush, insulating, terminal	407019	407019	102494	102494	407019
§ Pad, insulating, terminal	492468	492468	492468	492468	—
§ Washer, insulating, terminal	491335	491335	—	171714	491335
§ Strip, cutout	—	—	171714	171714	—
§ Cover, rubber, cutout terminal	54440357	54440357	—	—	54440357
§ Set of parts for cutout switch change-over	492709	492709	—	—	492709
§ Sundry parts, set	491264	491264	490663	490663	491264
	490663	490663	—	—	490663

FLYWHEEL MAGNETOS DETAILED SPARE PARTS

Model Rotation	7F1 Clockwise	8F1 Clockwise
Flywheel	54440610	54441000
Cam	—	469363
Stator	42376A/B	42372A/D
Nut, condenser	165033	165033
Condenser	469153	469153
Contact set	54440026	469403
Ring, retaining	154660	154660
Felt and spring, lubricator	54440631	54440632

MAGNETO AUTO-ADVANCE UNITS DETAILED SPARE PARTS

Part No. Model Range Rotation Number of teeth	47502A/B K2F 15°-18° Anti-clock 50	47503A/E K2F 11°-13° Anti-clock 44	47508A/D K2F 11°-13° Anti-clock 18	47545A/B K1F 11°-13° Anti-clock 92	47553A/B SR2 11°-13° Clockwise 19	47556A/B SR1 11°-13° Anti-clock 40	47576A K1F 11°-13° Anti-clock 92
Washer, cover clip	498131	498131	498131	498131	498131	498131	498131
Washer, disc cover	498339	498339	498339	498339	498339	498339	498339
Washer, sec	498157/S	498157/S	498157/S	498157/S	498157/S	498157/S	407256/S
Nut, fixing	498303	498303	498303	498303	498303	498303	498303

* When ordering, quote part number shown in brackets

§ Recommended spares for stock

DETAILED SPARE PARTS

Part No.	42133E K1F Anti-clock Fixed	42133F K1F Anti-clock Fixed	42133H K1F Anti-clock Fixed	42183E/F K1F Anti-clock Right hand	42183H K1F Anti-clock Right hand	42230B/D K2F Anti-clock Right hand	42230E K2F Anti-clock Right hand	*42248E K2F Anti-clock Fixed (42379)	*42263D K2F Anti-clock Left hand (42380)	42264A K2F Anti-clock Right hand	42264B K2F Anti-clock Right hand	42264D K2F Anti-clock Right hand
Replaced by												
Clip, grommet				455733		455734				455734	455734	455734
Cover or grommet, pick-up (rubber)				450426	450426	458658	458658			458658	458658	458658
§Pick-up	456794	456794	456794	456794	456794	1458367	1458367	1458865	459190	1458367	1458367	1458367
§ Brush and spring	451260	451260	451260	451260	451260	451260	451260	451260	451260	451260	451260	451260
§ Nut, moulded	410600	410600	410600	410600	410600	410600	410600	410600	410600	410600	410600	410600
Washer, seating, pick-up	455622	455622	455622	455622	455622	458346	458346	458346	458346	458346	458346	458346
§Cover, contact breaker	458647	458647	458647	458647	458647	459037	459037	458619	458619	458619	458619	458619
Nut, moulded								458622	458622	458622	458622	458622
Screw, contact breaker fixing	122160	122160	492856	122160	492856	122160	492856	122160	122160	122160	122160	492856
§Contact breaker	470534	470534	492854	470534	492854	470534	492854	470534	470534	470534	470534	492854
Bush, insulating, centre of contact breaker	470555	470555		470555		470555		470555	470555	470555	470555	
Bush, insulating, contact screw block	470684	470684		470684		470684		470684	470684	470684	470684	
Screw, bracket or carrier fixing			100614		100614		100614					100614
Washer, insulating			161681		161681		161681					161681
Bush, insulating			492853		492853		492853					492853
§Contact set	470609	470609	54440888	470609	54440888	470609	54440888	470609	470609	470609	470609	54440888
Ring, retaining lever			154660		154660		154660					154660
Washer, insulating ring			161673		161673		161673					161673
§Springs, set, actuating	470688	470688		470688		470688		470688	470688	470688	470688	
Bracket, supporting springs	470537		493202		493202		493202					493202
§ Brush and spring		470537		470537		470537		470537	470537	470537	470537	
§Control parts, set				463107	463107	458364	458364		463107	463107	463107	463107
Spring				454472	454472		454472		454472	454472	454472	454472
Nipple, cable				455788		455788						455788
§ Cap, rubber				454475	454475	454475	454475		454475	454475	454475	454475
Clip, cap securing				455734	455734							
Washer, barrel, seating				164724	164724		163343					
Plunger				454969	454969	454969	454969		454969	454969	454969	454969
Screw, adjusting				111591	111591				111591	111591	111591	111591
Nut, adjusting screw				170124	170124				170124	170124	170124	170124
§Cam	459238	459238	459238	459156	459156	458725	458725	459130	458389	458725	458725	458725
§Plate, housing, contact breaker	459105	459105	459105	458726	458726	459036	459036	459105	458726	458726	458726	458726
§ Cup, bearing, insulating	451379	451379	451379	451379	451379	451379	451379	451379	451379	451379	451379	451379
Shim, .005", packing, contact breaker housing	458356	458356	458356	458356	458356	458356	458356	458356	458356	458356	458356	458356
Screw, cam or timing fixing	463931	463931	463931	463931	463931	463931	463931	463931	463931	463931	463931	463931
Pin, cam timing screw	186060	186060	186060	186060	186060	186060	186060	186060	186060	186060	186060	186060
§Spring and pin, contact breaker cover	458613	458613	458613	458613	458613	458613		458613	458613	458613	458613	458613
§Nut, shaft				170109	170109	170109						170109
Washer, shaft nut				140074	140074	140074						140074
§Armature	458361	459139	459139	459139	459139	459004	459004	459004	459004	458333	459004	459004
§ Slip ring	454496	454496	454496	454496	454496	455361	455361	455361	455361	455361	455361	455361
Bolt, through fixing	458514	458514	458514	458514	458514	458514	458514	458514	458514	458514	458514	458514
Condenser	458339	458339	458339	458339	458339	458339	458339	458339	458339	458339	458339	458339
Oil thrower	463944	463944	463944	463944	463944	463944	463944	463944	463944	463944	463944	463944
Washer, linen						164334		164334				
Collar, spacing	455634	455634	455634	455634	455634	455340	455634	455340	455634	455634	455634	455634
Collar, bearing retaining	455340	455340	455340	455340	455340		455340		455340	455340	455340	455340
§Bearing, contact breaker end	189291	189291	189291	189291	189291	189291	189291	189291	189291	189291	189291	189291
§Bearing, drive end	189291	189244	189244	189244	189244	189244	189244	189244	189244	189291	189244	189244
§Cup, insulating, bearing	451379	459005	459005	459005	459005	459005	459005	459005	459005	451379	459005	459005
§Oil, seal or washer	459033	459002	459002	459002	459002	459002	459002	459002	459002	459033	459002	459002
§Brush, spring and holder, magneto earth	455191	455191	455191	455191	455191	455191	455191	455191	455191	455191	455191	455191
§ Brush and spring	455190	455190	455190	455190	455190	455190	455190	455190	455190	455190	455190	455190

MAGNETOS - MODELS K1F, K2F AND N14

DETAILED SPARE PARTS

Part No. Model Rotation Control	42272A, B N14 Anti-clock Right hand	42298A, B K2F Anti-clock Right hand	42298B K2F Anti-clock Right hand	4234... D K2F Anti-clock Fixed	42344E K2F Anti-clock Fixed	42369A K2F Clockwise Left hand	42369B K2F Clockwise Left hand	42379A K2F Anti-clock Fixed	42379B-D K2F Anti-clock Fixed	42380A K2F Anti-clock Right hand	42380B, D K2F Anti-clock Right hand	42413A K2F Anti-clock Left hand
Cover or grommet, pick-up (rubber)			458658		458658		458658		458658			
§ Pick-up	463066	458876	458876	458876	458876	1458367	1458367	1458865	1458865	459190	459190	459190
§ Brush and spring	451260	451260	451260	451260	451260	451260	451260	451260	451260	451260	451260	451260
§ Nut, moulded	410600	410600	410600	410600	410600	410600	410600	410600	410600	410600	410600	410600
§ Washer, seating, pick-up	455622	458877				458346	458346	458346	458346	458346	458346	458346
§ Cover, contact breaker	460061	459269	459269	459269	459269	458619	458619	459269	459269	459269	459269	459269
§ Nut, moulded						458622	458622					
§ Ring, sealing, contact breaker cover (rubber)		457681	457681	457681	457681			457681	457681	457681	457681	457681
§ Cap, breather or baffle		459266	459266	459266	459266			459266	459266	459266	459266	459266
§ Screw, contact breaker fixing	110739	122160	492856	122160	492856	122160	492856	122160	492856	122160	492856	492856
§ Contact breaker	460051	470534	492854	470534	492854	470533	493836	470534	492854	470534	492854	492854
§ Bush, insulating, centre of contact breaker	460066	470555		470555		470555		470555		470555		
§ Bush, insulating, contact screw block		470684		470684		470684		470684		470684		
§ Screw, bracket or carrier fixing	460067		100614		100614		100614		100614		100614	100614
§ Washer, insulating			161681		161681		161681		161681		161681	161681
§ Bush, insulating	463983		492853		492853		492853		492853		492853	492853
§ Wick, felt, cam lubricating	460068											
§ Plate, insulating, carrier to base	460065											
§ Tapet, celeron	464092											
§ Washer, locking	460052											
§ Contact set	484098	470609	54440888	470609	54440888	470608	54440887	470609	54440888	470609	54440888	54440888
§ Ring, retaining lever			154660		154660		154660		154660		154660	154660
§ Washer, insulating ring			161673		161673		161673		161673		161673	161673
§ Springs, set, actuating		470688		470688		470688		470688		470688		470688
§ Bracket, supporting springs			493202		493202		493202		493202		493202	493202
§ Brush and spring		455190	455190	455190	455190	470537		455190	455190	455190	455190	455190
§ Control parts, set	463107	492195	492195			463107	463107		463107	463107	463107	463107
§ Spring	454472		454472				454472				454472	454472
§ Nut, cable stop, lock	170124											
§ Nipple, cable	455788	455788	455788			455788	455788		455788			
§ Cap, rubber	454475	454475	454475			454475	454475		454475	454475	454475	454475
§ Washer, barrel, seating	454492						163343					
§ Barrel	454467											
§ Plunger	454969	493304	493304			454969	454969		454969	454969	454969	454969
§ Screw, adjusting	111591		111591				111591				111591	111591
§ Nut, adjusting screw			170124				170124				170124	170124
§ Ring, jump, cam fixing	455347											
§ Cam	493178	458725	458725	459130	459130	458855	458855	459130	459130	458725	458725	458725
§ Plate, housing, contact breaker	464317	459271	459271	493716	493716	493747	493747	54440096	54440096	54440090	54440090	54440090
§ Cup, bearing, insulating	451379	463932	463932	463932	463932	451379	451379	451379	451379	451379	451379	451379
§ Shim, .005", packing, contact breaker housing	452907	452907	452907	452907	452907	458356	458356	458356	458356	458356	458356	458356
§ Screw, end plate, seal	454694											
§ Screw, cam or timing fixing	463931	463931	463931	463931	463931	463931	463931	463931	463931	463931	463931	463931
§ Pin, cam timing screw	186060	186060	186060	186060	186060	186060	186060	186060	186060	186060	186060	186060
§ Spring and pin, contact breaker cover	451315					458613	458613					
§ Nut, shaft	170109	170109	170109	170109	170109	170109	170109					
§ Washer, shaft nut	140074	140074	140074	140074	140074	140074	140074					
§ Armature	454385	459004	459004	459004	459004	459142	459142	459004	459004	459004	459004	459004
§ Slip ring	454496	455361	455361	455361	455361	454497	454497	455361	455361	455361	455361	455361
§ Bolt, through fixing	101270	458514	458514	458514	458514	458514	458514	458514	458514	458514	458514	458514
§ Condenser	454415	458339	458339	458339	458339	458339	458339	458339	458339	458339	458339	458339
§ Oil thrower	463944	463944	463944	463944	463944	463944	463944	463944	463944	463944	463944	463944
§ Washer, linen	164334	164334	164334	164334	164334	164334	164334			164334		
§ Collar, spacing	455634	455340	455634	455340	455634	455340	455634	455340	445634	455340	455634	455634
§ Collar, bearing retaining			455340		455340		455340		455340		455340	455340
§ Bearing, contact breaker end	189291	189291	189291	189291	189291	189291	189291	189291	189291	189291	189291	189291
§ Bearing, drive end	189244	189244	189244	189244	189244	189244	189244	189244	189244	189244	189244	189244
§ Cup, insulating, bearing	451379	459005	459005	459005	459005	459005	459005	459005	459005	459005	459005	459005
§ Oil, seal or washer	458375	459002	459002	459002	459002	459002	459002	459002	459002	459002	459002	459002
§ Brush, spring and holder, magneto earth	455191	455191	455191	455191	455191	455191	455191	455191	455191	455191	455191	455191
§ Brush and spring	455190	455190	455190	455190	455190	455190	455190	455190	455190	455190	455190	455190
§ Spring and pin, pick-up						458370	458370	458370	458370	458370	458370	458370
§ Sundry parts, set	454697	458675	458675	458675	458675	458675	458675	458675	458675	458675	458675	458675

* When ordering, quote part number shown in brackets † Right hand ‡ Left hand § Recommended spares for stock ¶ Ignition cutout

MAGNETOS - MODELS K1F, K2F AND N14

DETAILED SPARE PARTS

Part No.	42123M KNR1-5 Anti-clock Right hand	42157K KNR1 Anti-clock Right hand	42324B K2FR Anti-clock Right hand	42346A K1FC Anti-clock Right hand	42346B K1FC Anti-clock Right hand	42347A/D NC1 Anti-clock Right hand	42347E NC1 Anti-clock Right hand	42348A/D KNC1 Anti-clock Right hand	42348E KNC1 Anti-clock Right hand
Clip, fixing, pick-up cover	455733	455733	455734	455733	455733	455733	455733	455733	455733
Cover, pick-up (rubber)	457810	457810	458658	457810	457810	457810	457810	457810	457810
§ Pick-up	456794	456794	458876	456794	456794	456794	456794	456794	456794
§ Brush and spring	451260	451260	451260	451260	451260	451260	451260	451260	451260
§ Nut, moulded	455791	455791	410600	410600	410600	410600	410600	410600	410600
Washer, seating, pick-up	455622	455622	458877	455622	455622	455622	455622	455622	455622
§ Cover, contact breaker	459199	459199	459205	459199	459199	459199	459199	459199	459199
Ring, sealing, cover (rubber)	457681	457681	457681	457681	457681	457681	457681	457681	457681
Screw, drain plug	135444	135444	—	135423	135423	135444	135444	135444	135444
Bolt, securing, breather cap	459198	459198	—	459198	459198	459198	459198	459198	459198
Cap, breather or bulk	459194	459194	459194	459194	459194	459194	459194	459194	459194
Brush and spring, ignition cutout	—	—	455190	—	—	—	—	—	—
Screw, contact breaker fixing	455233	455233	122160	122160	5440869	455233	5440869	455233	5440869
§ Contact breaker	470924	470924	470914	470534	492854	470534	492854	470534	492854
§ Contact set	—	—	—	470609	5440888	470609	5440888	470609	5440888
Ring, retaining lever	—	—	—	—	154660	—	154660	—	154660
Washer, insulating ring	—	—	—	—	161673	—	161673	—	161673
§ Brush and spring	470537	470537	470537	470537	—	470537	—	470537	—
Screw, spring bracket fixing	—	—	—	—	100614	—	100614	—	100614
Washer, insulating, bracket screw	—	—	—	—	161681	—	161681	—	161681
Bush, insulating, spring bracket	—	—	—	—	492853	—	492853	—	492853
Bracket, spring supporting	—	—	—	—	493202	—	493202	—	493202
Springs, set, actuating	—	—	—	470688	—	470688	—	470688	—
Bush, insulating, centre of contact breaker	—	—	—	470555	—	470555	—	470555	—
Bush, insulating, contact screw block	—	—	—	470684	—	470684	—	470684	—
§ Control parts, set, advance and retard	457117	457117	457117	459305	459305	459305	459305	459305	459305
Spring	454472	454472	—	454472	454472	454472	454472	454472	454472
Cap, rubber	454475	454475	454475	454475	454475	454475	454475	454475	454475
Clip, cap securing	455734	455734	455734	455734	455734	455734	455734	455734	455734
Washer, barrel seating	164724	164724	—	164724	164724	164724	164724	164724	164724
Plunger	493454	493454	493454	493304	493304	493304	493304	493304	493304
Nipple	455788	455788	455788	455788	455788	455788	455788	455788	455788
Screw, adjusting	111591	111591	—	111591	111591	111591	111591	111591	111591
Nut, adjusting screw	170124	170124	—	170090	170090	170124	170124	170124	170124
§ Plate, housing, contact breaker	—	—	—	459304	459304	459313	459313	459313	459313
§ Cup, insulating, bearing	—	—	—	463932	463932	463932	463932	463932	463932
Shim, contact breaker end packing, .003"	—	—	—	452906	452906	—	—	—	—
Shim, contact breaker end packing, .005"	—	—	—	452907	452907	452907	452907	452907	452907
Screw, cam fixing	—	—	—	463931	463931	463931	463931	463931	463931
Pin, cam timing screw	—	—	—	186060	186060	186060	186060	186060	186060
§ Cam	—	—	—	459321	459321	459321	459321	459321	459321
§ Nut, gear to shaft securing	170109	170109	170109	170104	170104	170109	170109	170109	170109
Washer, gear securing nut	140074	140074	140074	140074	140074	140074	140074	140074	140074
§ Armature	—	—	—	459375	459375	493176	493176	493176	493176
§ Slip ring	—	—	—	456277	464277	464277	464277	464277	464277
Bolt, through fixing	—	—	—	458514	458514	101270	101270	101270	101270
Condenser	—	—	—	—	—	454415	454415	454415	454415
Oil thrower	—	—	—	463944	463944	463944	463944	463944	463944
Collar, steel, bearing retaining	—	—	—	455340	455340	455340	455340	455340	455340
§ Bearing, contact breaker end	—	—	—	189294	189294	189294	189294	189294	189294
§ Bearing, drive end	—	—	—	189244	189244	189294	189294	189294	189294
§ Oil seal	—	—	—	459002	459002	459033	459033	459033	459033
§ Cup, insulating, drive end bearing	—	—	—	459005	459005	463932	463932	463932	463932
§ Brush, spring and holder, carthing	455191	455191	455191	455191	455191	455191	455191	455191	455191
§ Brush and spring, carthing	455190	455190	455190	455190	455190	455190	455190	455190	455190
§ Sundry parts, set	458869	458869	458869	458869	458869	454697	454697	454697	454697

COMPETITION MAGNETOS - MODELS K1FC, K2FC, K2FR, KNC1, KNR1 & NCI

Part & Model Rotation Control	42349A/D KNC1 Anti-clock Right hand	42349E KNC1 Anti-clock Right hand	42349F K2FC Anti-clock Right hand	4235011 K2FC Anti-clock Right hand	42368A K2FC Anti-clock Fixed	42368D K2FC Anti-clock Fixed	42371A NC1 Anti-clock Right hand	42371B NC1 Anti-clock Right hand	17A NC1 Anti-clock Right hand
Clip, fixing, pick-up cover	455733	455733	455734	455734	455734	455734	455733	455733	455733
Cover, pick-up (rubber)	457810	457810	458658	458658	458658	458658	457810	457810	457810
§ Pick-up	456794	456794	458876	458876	458876	458876	456794	456794	456794
§ Brush and spring	451260	451260	451260	451260	451260	451260	451260	451260	451260
§ Nut, moulded	410600	410600	410600	410600	410600	410600	410600	410600	410600
Washer, seating, pick-up	455622	455622	458877	458877	458877	458877	455622	455622	455622
§ Cover, contact breaker	459199	459199	459205	459205	459205	459205	459205	459205	459199
Ring, sealing, cover (rubber)	457681	457681	457681	457681	457681	457681	457681	457681	457681
Screw, drain plug	135444	135444	135444	135444	135444	135444	135444	135444	—
Bolt, securing, breather cap	459198	459198	—	—	—	—	—	—	—
Cap, breather or baffle	459194	459194	459194	459194	459194	459194	459194	459194	—
Brush and spring, ignition cutout	—	—	455190	455190	455190	455190	455190	—	—
Screw, contact breaker fixing	455233	54440869	122160	492856	122160	492856	455233	54440869	54440869
§ Contact breaker	470534	492854	470534	492854	470534	492854	470534	492854	492854
§ Contact set	470609	54440888	470609	54440888	470609	54440888	470609	54440888	54440888
Ring, retaining lever	—	154660	—	154660	—	154660	—	154660	154660
Washer, insulating ring	—	161673	—	161673	—	161673	—	161673	161673
§ Brush and spring	470537	—	470537	—	470537	—	470537	—	—
Screw, spring, bracket fixing	—	100614	—	100614	—	100614	—	100614	100614
Washer, insulating, bracket screw	—	161681	—	161681	—	161681	—	161681	161681
Bush, insulating, spring bracket	—	492853	—	492853	—	492853	—	492853	492853
Bracket, spring supporting	—	493202	—	493202	—	493202	—	493202	493202
Springs, set, actuating	470688	—	470688	—	470688	—	470688	—	—
Bush, insulating, centre of contact breaker	470555	—	470555	—	470555	—	470555	—	—
Bush, insulating, contact screw block	470684	—	—	—	—	—	470684	—	—
§ Control parts, set, advance and retard	459305	459304	459305	459305	—	—	459305	459305	459305
Spring	454472	454472	454472	454472	—	—	454472	454472	454472
Cap, rubber	454475	454475	454475	454475	—	—	454475	454475	454475
Clip, cap securing	455734	455734	455734	455734	—	—	455734	455734	455734
Washer, barrel seating	164724	164724	164724	164724	—	—	164724	164724	164724
Plunger	493304	493304	493304	493304	—	—	493304	493304	493304
Nipple	455788	455788	455788	455788	—	—	455788	455788	455788
Screw, adjusting	111591	111591	111591	111591	—	—	111591	111591	111591
Nut, adjusting screw	170124	170124	170124	170124	—	—	170124	170124	170124
§ Plate, housing, contact breaker	459313	459313	459271	459271	493716	493716	459313	459313	459313
§ Cup, insulating, bearing	463932	463932	463932	463932	463932	463932	463932	463932	463932
Shim, contact breaker end packing, .005"	452907	452907	452907	452907	452907	452907	452907	452907	452907
Screw, cam fixing	463931	463931	463931	463931	463931	463931	463931	463931	463931
Pin, cam timing screw	186060	186060	186060	186060	186060	186060	186060	186060	186060
§ Cam	459321	459321	458725	458725	459130	459130	459321	459321	459321
§ Nut, gear to shaft securing	170109	170109	170109	170109	170109	170109	170109	170109	170109
Washer, gear securing nut	140074	140074	140074	140074	140074	140074	140074	140074	140074
§ Armature	493176	493176	459376	459376	459376	459376	493176	493176	493176
§ Slip ring	464277	464277	456727	456727	456727	456727	464277	464277	464277
Bolt, through fixing	101270	101270	458514	458514	458514	458514	101270	101270	101270
Condenser	454415	454415	—	—	—	—	454415	454415	454415
Oil thrower	463944	463944	463944	463944	463944	463944	463944	463944	463944
Washer, linen	—	—	164334	164334	164334	—	—	—	—
Collar, steel, bearing retaining	455340	455340	455340	455340	455340	455340	455340	455340	455340
§ Bearing, contact breaker end	189294	189294	189294	189294	189294	189294	189294	189294	189294
§ Bearing, drive end	189294	189294	189244	189244	189244	189244	189294	189294	189294
§ Oil seal	459033	459033	459002	459002	459002	459002	459033	459033	459033
§ Cup, insulating, drive end bearing	463932	463932	459005	459005	459005	459005	463932	463932	463932
§ Brush, spring and holder, earthing	455191	455191	455191	455191	455191	455191	455191	455191	455191
§ Brush and spring, earthing	455190	455190	455190	455190	455190	455190	455190	455190	455190
§ Sundry parts, set	454697	454697	458675	458675	458675	458675	454697	454697	454697

§ Recommended spares for stock

MAGDYNOS — MODEL MOIL



Model Interpretation

MOI As MN, but with face type cam.

1 For use on single cylinder engines.

L Long type generator fitted.

DETAILED SPARE PARTS

Part No.	46047A/B MOIL Anti-clock Right hand spring, Right hand pick-up	46048A MOIL Anti-clock Right hand spring, Left hand pick-up	46049A MOIL Anti-clock Right hand spring, Left hand pick-up	46051A/B MOIL Anti-clock Left hand spring, Right hand pick-up
GENERATOR PORTION				
Model	20034A/B E3LM	20034A/B E3LM	20034A/B E3LM	20034A/B E3LM
§Brushes, set	200737	200737	200737	200737
§Bracket or frame, commutator end	200713/S	200713/S	200713/S	200713/S
§Bearing, commutator end	189210	189210	189210	189210
§Washer, felt, bearing	200708	200708	200708	200708
§Cup, felt, bearing, washer	200709	200709	200709	200709
§Insulating plate (complete with brush boxes)	200911	200911	200911	200911
§Springs, set, tension	220197	220197	220197	220197
§Ring, sealing, rubber	369201	369201	369201	369201
§Cover, commutator end	200923	200923	200923	200923
§Grommet, cable	200895	200895	200895	200895
§Plate, clamping, terminal	200908	200908	200908	200908
§Bearing, drive end	189307	189307	189307	189307
§Bracket or frame, drive end	200912	200912	200912	200912
§Plate, bearing	200262	200262	200262	200262
§Screw, generator to magneto	123063	123063	123063	123063
§Nut, bearing retaining	200224	200224	200224	200224
§Gear, driving	454495	454495	454495	454495
§Screw, end, retaining gear	111704	111704	111704	111704
§Armature	200754	200754	200754	200754
§Field coils, set	200731	200731	200731	200731
§Bolt, through fixing	200732	200732	200732	200732
§Sundry parts, set	200806	200806	200806	200806
MAGNETO PORTION				
Cover, drive end fairing	464243	464247	464240	464242
§Strap, generator securing	200907	—	200907	—
§Bush, generator strap	460056	460056	460056	460056
§Grommet, pick-up	460055	460055	460055	460055
§Pick-up	458658	458658	458658	—
§Brush and spring	463066	463066	463066	463066
§Nut, moulded, high tension cable securing	451260	451260	451260	451260
§Washer, langite, pick-up seating	410600	410600	410600	410600
§Cover, contact breaker	455622	455622	455622	458346
§Screw, contact breaker fixing	460061	460061	460061	460061
§Washer, locking, contact breaker fixing screw	110734	110734	110734	110734
§Contact breaker, complete	460052	460052	460052	460052
§Contact set	460051	460051	460051	460051
§Plate, insulating, carrier	484098	484098	484098	484098
§Bush, insulating, carrier fixing screw	460065	460065	460065	460065
§Bush, insulating, centre of contact breaker	463983	463983	463983	463983
§Screw, special, hollow, carrier fixing	460066	460066	460066	460066
§Wick, felt, cam lubricating	460067	460067	460067	460067
§Tappet, actuating, contact point	460068	460068	460068	460068
§Ring, jump, cam fixing	464092	464092	464092	464092
§Cam	455347	455347	455347	455347
§Control parts, advance and retard	493181	493181	493181	464056
§Spring	463107	463107	463107	463107
§Cover, rubber	454472	454472	454472	—
§Washer, locking, barrel	454475	454475	454475	454475
§Plunger, cam controlling	454492	454492	454492	454492
§Nipple, cable	454969	454969	454969	454969
§Spring and pin, contact breaker cover securing	455788	455788	455788	455788
§Terminal, earthing	463899	463899	463899	463899
§Screw, sealing	186471	186471	186471	186471
§Plate, end housing, contact breaker	454694	454694	454694	454694
§Cup, insulating, bearing	464255	464255	464255	464255
§Pin, cam timing screw	451379	451379	451379	451379
§Screw, cam timing	186060	186060	186060	—
§Washer, .003", end plate packing	463931	463931	463931	—
§Nut, shaft	463075	463075	463075	463075
§Washer, shaft nut	170109	173974	170109	173974
§Plate, drive end	140074	140074	140074	140074
§Washer, paper, drive end plate	463989	463989	463989	463989
§Gear set, generator and magneto	460053	460053	460053	460053
§Nut, magneto gear fixing	462863	462863	462863	462863
§Washer, locking, gear nut	463117	463117	463117	463117
§Spring, star, gear clutch	463113	463113	463113	463113
§Plate, friction, gear	463114	463114	463114	463114
§Gear, celeron	463112	463112	463112	463112
§Armature	463109	463109	463109	463109
§Slip ring	464205	464205	464205	464205
§Bolt, through fixing	454496	454496	454496	454496
§Condenser	101270	101270	101270	—
§Washer, linen, slip ring to oil thrower	454415	454415	454415	454415
§Oil thrower	164334	164334	164334	164334
§Collar, steel, bearing packing	463944	463944	463944	463944
§Washer, shim .005", bearing packing	455634	455634	455634	455634
§Bearing, complete, contact breaker end	149010	149010	149010	149010
§Bearing, complete, drive end	189291	189291	189291	189291
§Key, Woodruff	189294	189294	189294	189294
§Brush, spring and holder, earthing	189386	189386	189386	189386
§Brush and spring	455191	455191	455191	455191
§Washer, fibre, earth brush holder	455190	455190	455190	455190
§Cup, insulating, bearing	164680	164680	164680	161728
§Sundry parts, set	463932	463932	463932	463932
	463334	463334	463334	463334

§ Recommended spares for stock



STARTING MOTORS, CONTACT BREAKER UNITS AND DISTRIBUTORS

STARTING MOTORS

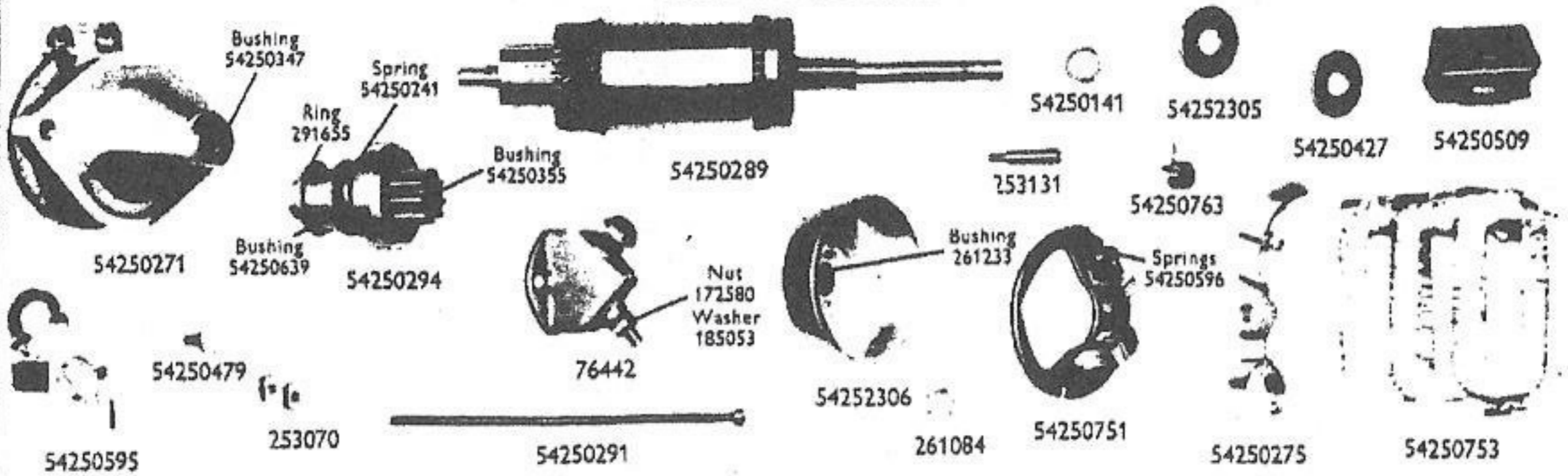

CONTACT BREAKER UNITS

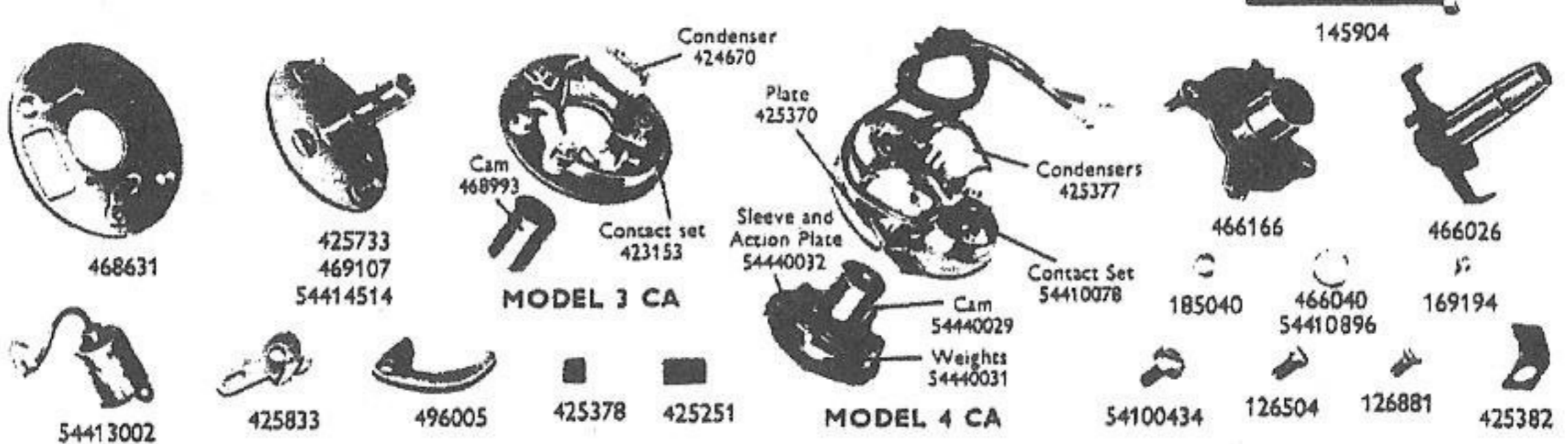

DISTRIBUTORS

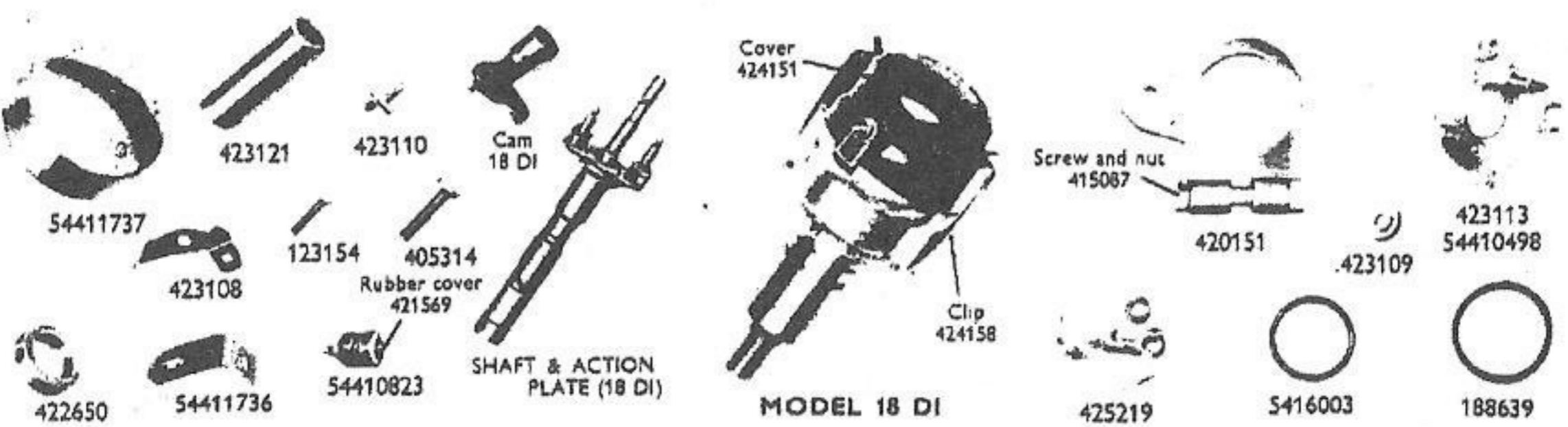

"SR" MAGNETOS

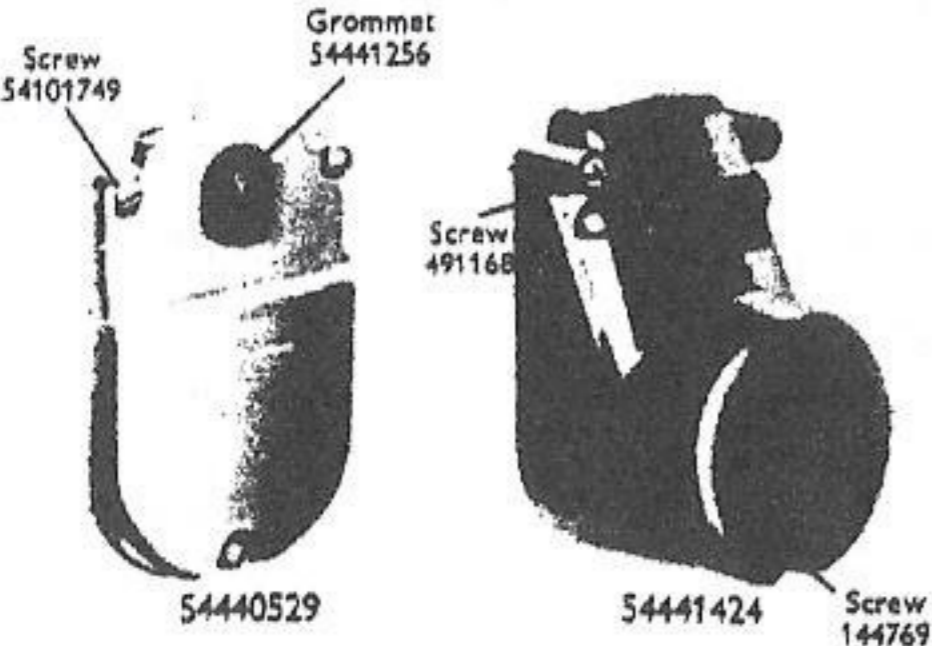

SUPPRESSORS & COILS

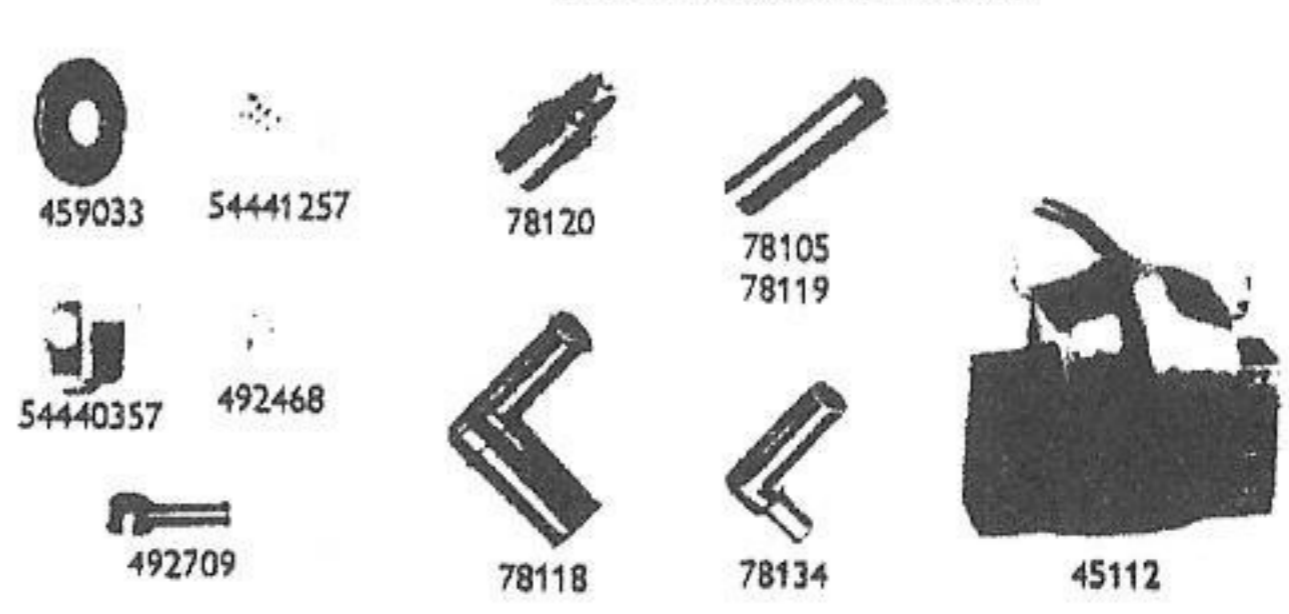

MAGNETOS



FLYWHEEL MAGNETOS

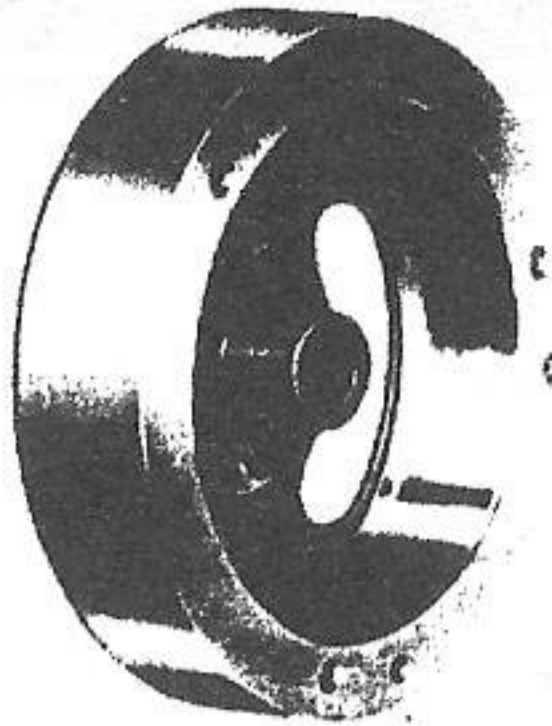

54440610

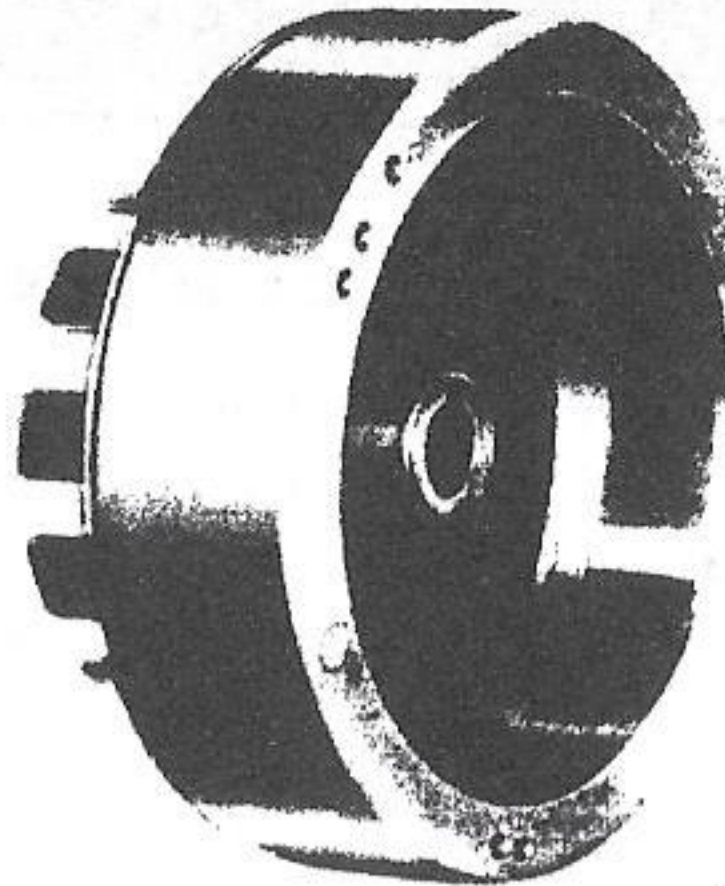

54441000



469363

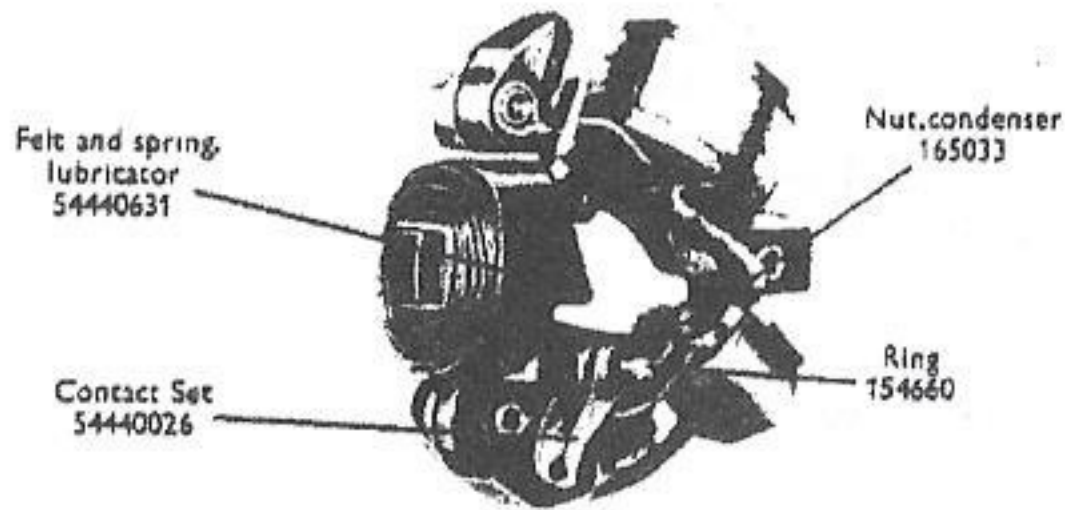

Felt and spring lubricator 54440631

Nut, condenser 165033

Contact Set 54440026

Ring 154660

42376

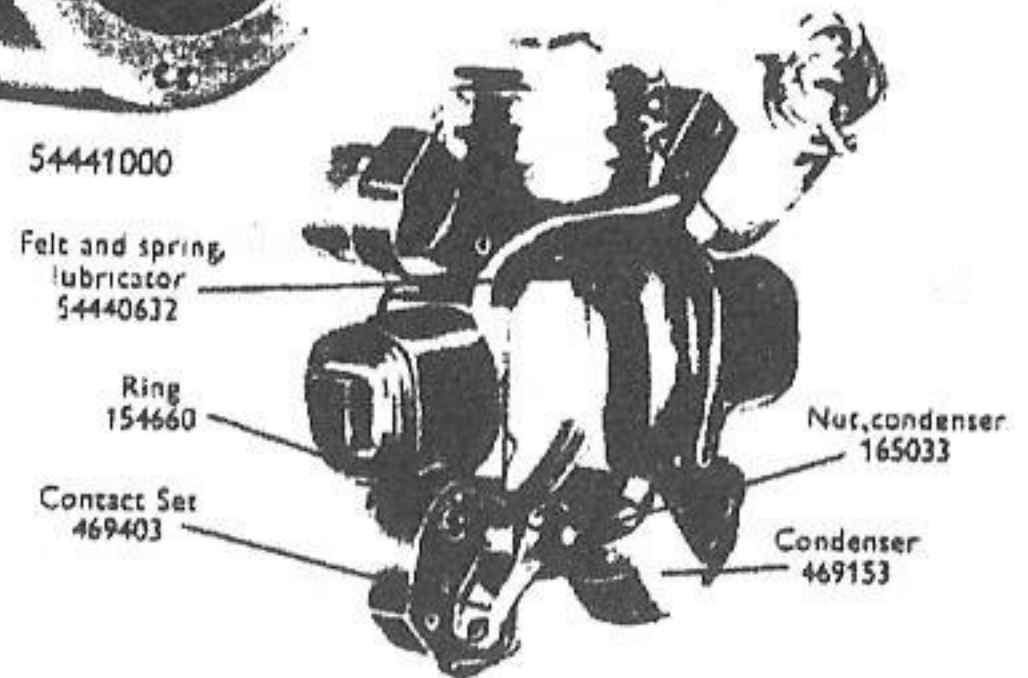

Felt and spring lubricator 54440632

Ring 154660

Contact Set 469403

Nut, condenser 165033

Condenser 469153

42372

MAGNETOS

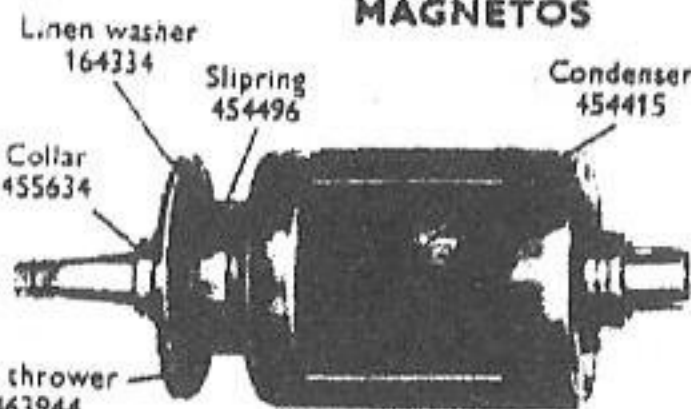

TYPICAL N14 ARMATURE

Nut 410600

Washer 455622

Brush and Spring 451260

463066

Spring 454472

Plunger 454969 493304

460061

Linen washer 164334

Slipring 454496

Condenser 454415

Collar 455634

Oil thrower 463944

Bush 470555 470684

Springs 470688

Contact Set 470609

470534 470914 470924

Screw 100614

492854 493836

Insulating plate 460065

Ring 154660

Contact set 54440887 54440888

Wick 460068
Screw 110739
Tappet 464092

460051

458356

452907

484098

460066

Nipple 455788

CONTROL PARTS SET (TYPICAL)



458726
459036
54440090



493178



101270
458514

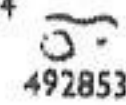

492853



493202



463931

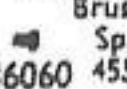

186060



189291
189294



458375



451315



161673
161681

Brush and Spring 455190

455191

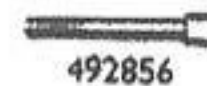

492856



54440869

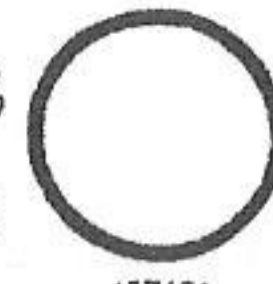

457681



451379 463932
459005

140074

170109



464317
493747



459105
54440096

CONTENTS

<i>Description</i>	<i>Page</i>	<i>Description</i>	<i>Page</i>
Bulb Specification	G26-27	Warning Lights	
Headlamps		Detailed parts	G25
Detailed parts	G2-23	Reflex Reflectors	
Side, Sidecar, Flasher and Pilot Lamps		Detailed parts	G26
Detailed parts	G25	Fog and Driving Lamps	
Tail, Stop Tail and Number Plate Lamps		Detailed parts	G28-29
Detailed parts	G24	Flasher Sets	
		Detailed parts	G30
		Inspection Lamps	
		Detailed parts	G30

Model Interpretation

<i>Model</i>	<i>Description</i>
F700	Flush fitting; 7" aperture.
MCF575P	Flush fitting; less body; with pilot; 5 $\frac{3}{4}$ " aperture.
MCF700	Flush fitting; less body; 7" aperture.
MCF700P	Flush fitting; less body; with pilot; 7" aperture.
MCH52	Ammeter or switch fitted in hemispherical body; 7" aperture; side socket fixing.
MCH55	Ammeter and switch mounted in headlamp body, which is pierced for speedometer; stepped rim to accommodate 7" light unit; side socket fixing.
MCH56	Elongated body with piercing for speedometer; ammeter and switch mounted in headlamp body; 5 $\frac{3}{4}$ " aperture; side socket fixing.
MCH57	Special two-piece body; switch and ammeter mounted in top half, which is pierced for speedometer; 7" aperture; side socket fixing.
MCH58	Detachable switch panel fitted in headlamp body; 7" aperture; side socket fixing.
MCH60	Shallow body; 7" aperture.
MCH61	Ammeter and switch mounted in headlamp body; 7" aperture; side socket fixing.
MCH64	Suitable for mopeds; 4 $\frac{1}{2}$ " aperture; switch mounted in body.
MCH66	6" aperture; switch mounted in body; side socket fixing.
MU42	Standard lamp with separate reflector and lens; reflector held with rubber bead; switch panel mounted in headlamp body; 6" aperture; side socket fixing.
SS700P	With pilot; 7" aperture; side socket fixing.
SSU700	Switch panel mounted in headlamp body; 7" aperture; side socket fixing.
SSU700P	Switch panel mounted in headlamp body; with pilot; 7" aperture; side socket fixing.

Note: Suffix EF denotes Export France



HEADLAMPS WITH AMMETERS AND SWITCHES

DETAILED SPARE PARTS

Part No.	*50791D	51625A	51632A	*51686D	*51706A	51709A	51751A	*51788A
Model	MU42	MU42	SSU700P/ EF	SSU700P	MCH55	MCH55	SSU700	SSU700P
Replaced by	(51625)	—	—	(51829)	(51709)	—	—	(51832)
(1) Instrument panel, complete ..	516524	516524	516524	516524	—	—	516993	516524
(2) Screw, panel fixing ..	186130	186130	186130	186130	—	—	186130	186130
(3) Medallion ..	—	—	—	—	—	—	—	—
(4) Bead, panel seating ..	—	—	—	—	—	—	—	—
(5) Ammeter ..	36084	36084	36084	36084	36084	36084	36084	36084
(6) Ring, rubber, seating ..	523986	523986	523986	523986	523986	523986	523986	523986
(7) Nut, terminal ..	166043	166043	166043	166043	166043	166043	166043	166043
(8) Washer, terminal ..	185040	185040	185040	185040	185040	185040	185040	185040
(9) Switch, lighting ..	31340	31315	31340	31340	31340	31340	31684	31340
(10) Handle or knob ..	351567	351724	351567	351567	351567	351567	351567	351567
(11) Screw, fixing ..	126544	126544	126544	126544	126544	126544	126544	126544
(12) Washer, fixing ..	188408	188408	188408	188408	188408	188408	188408	188408
(13) Nut, fixing, front and rear ..	—	—	—	—	—	—	—	—
(14) Washer ..	—	—	—	—	—	—	—	—
(15) Bezel ..	—	—	—	—	—	—	—	—
(16) Shaft, headpiece ..	351501	351501	351501	351501	351501	351501	351773	351501
(17) Roller, contact ..	351660	351660	351660	351660	351660	351660	351660	351660
(18) Plunger, contact ..	351661	351661	351661	351661	351661	351661	351661	351661
(19) Spring, contact plunger ..	351662	351662	351662	351662	351662	351662	351662	351662
(20) Contact lever ..	—	—	—	—	—	—	351528	—
(21) Screw, terminal ..	120560	120560	120560	120560	120560	120560	120560	120560
(22) Spring, switch fixing ..	308234	308234	308234	308234	308234	308234	308234	308234
(23) Ring, rubber, fixing ..	523986	523986	523986	523986	523986	523986	523986	523986
(24) Nut, contact stud ..	166103	166103	166103	166103	166103	166103	166103	166103
(25) Screw, cable clip ..	186128	186128	186128	186128	—	—	186128	186128
(26) Washer, cable clip screw ..	188412	188412	188412	188412	—	—	188412	188412
(27) Rim or door ..	509484	509484	553248	553248	553435	553435	553248	553248
(28) Wire, fixing ..	509753/S	509753/S	504665	504665	553356	553356	504665	504665
(29) Screw or catch, rim fixing ..	509936	509936	144921	144921	509936	509936	144921	144921
(30) Spring, rim catch ..	509191	509191	—	—	509191	509191	—	—
(31) Bead, rubber, reflector ..	553065	553065	—	—	—	—	—	—
(32) Plate, rim fixing ..	—	—	534296	534296	—	—	534296	534296
(33) Light unit ..	—	—	516802	516798	516798	516798	553925	555275
(34) Lens ..	550875	550875	—	—	—	—	—	—
(35) Reflector ..	553147	553147	—	—	—	—	—	—
(36) Backshell ..	—	—	552943	—	—	—	—	—
(37) Bulb holder, main ..	504801	504801	562303	554602	554602	554602	554602	554602
(38) Sleeve, terminal ..	188818	188818	188818	188818	188818	188818	188818	188818
(39) Clip and screw ..	551807	551807	562306	—	—	—	—	—
(40) Bulb holder, pilot ..	—	—	554710	554710	554710	554710	—	554710
(41) Interior, pilot ..	500181	500181	553780	553780	553780	553780	—	553780
(42) Ring, bulb holder seating ..	—	—	554354	554354	554354	554354	—	554354
(43) Bush, cable entry ..	—	—	—	—	505980	505980	—	—
(44) Washer, cable grip, pilot ..	516285	516285	516285	—	516285	516285	—	—
(45) Washer, cable grip, main ..	—	—	—	—	—	—	—	—
(46) Screw, lamp fixing ..	112201	112201	112201	112201	112201	112201	112201	112201
(47) Washer, lamp fixing screw ..	137141	137141	137498	137141	137141	137141	137498	137141
(48) Nut, lamp fixing screw ..	—	—	—	187110	—	—	—	187110
(49) Plug and cable ..	†859260	†859260	—	—	—	—	—	—
(50) Screw, plug fixing ..	133303	133303	—	—	—	—	—	—
(51) Nut, plug fixing screw ..	166103	166103	—	—	—	—	—	—
(52) Washer, plug fixing screw ..	185012	185012	—	—	—	—	—	—
(53) Ring, plug, retaining ..	516409	516409	—	—	—	—	—	—
(54) Grommet, cable entry ..	—	—	—	—	862217	862217	—	—
(55) Grommet, trip cable ..	—	—	—	—	—	—	—	—
(56) Grommet, body ..	—	—	—	—	—	—	—	—
(57) Connector, single ..	—	—	—	—	—	—	—	—
(58) Nipple, cable ..	—	—	—	—	—	—	—	—
(59) Body ..	516402	516402	516358	516358	517020	517022	516358	516356
(60) Bulb, main ..	168	168	—	312	312	312	312	403
(61) Bulb, pilot ..	200	200	988	988	988	988	—	988

* When ordering, quote part number shown in brackets

† Socket 809795 for plug to be ordered separately

§ Recommended spares for stock

HEADLAMPS WITH AMMETERS AND SWITCHES



DETAILED SPARE PARTS

50791 — 51892

*51801E MCH58 (58091)	51829A SSU700P	51832A SSU700P	51845B MCH52	51846A MCH52	51847A MCH52EP	51847B MCH52 E/F	51854A SSU700P	*51876B MCH58 (51954)	51890A MCH52	51892A SSU700P	
517075	516524	516524	—	—	—	—	516524	517074	—	516524	(1)
130251	186130	186130	—	—	—	—	186130	130251	—	186130	(2)
397106	—	—	—	—	—	—	—	397092	—	—	(3)
517066	—	—	—	—	—	—	—	517066	—	516399	(4)
36084	36084	36084	36084	36084	36084	36084	36084	36084	36084	36084	(5)
523986	523986	523986	523986	523986	523986	523986	523986	523986	523986	523986	(6)
166043	166043	166043	166043	166043	166043	166043	166043	166043	166043	166043	(7)
185040	185040	185040	185040	185040	185040	185040	185040	185040	185040	185040	(8)
31340	31315	31315	—	—	—	—	31315	31340	—	31340	(9)
351567	351724	351724	—	—	—	—	351567	351567	—	351567	(10)
126544	126544	126544	—	—	—	—	126544	126544	—	126544	(11)
188408	188408	188408	—	—	—	—	188408	188408	—	188408	(12)
—	—	—	—	—	—	—	—	—	—	—	(13)
—	—	—	—	—	—	—	—	—	—	—	(14)
—	—	—	—	—	—	—	—	—	—	—	(15)
351501	351501	351501	—	—	—	—	351501	351501	—	351501	(16)
351660	351660	351660	—	—	—	—	351660	351660	—	351660	(17)
351661	351661	351661	—	—	—	—	351661	351661	—	351661	(18)
351662	351662	351662	—	—	—	—	351662	351662	—	351662	(19)
—	—	—	—	—	—	—	—	—	—	—	(20)
120560	120560	120560	—	—	—	—	120560	120560	—	120560	(21)
308234	308234	308234	—	—	—	—	308234	308234	—	308234	(22)
523986	523986	523986	—	—	—	—	523986	523986	—	523986	(23)
166103	166103	166103	—	—	—	—	166103	166103	—	166103	(24)
—	186128	186128	—	—	—	—	186128	—	—	186128	(25)
†185026	188412	188412	—	—	—	—	188412	†185026	—	188412	(26)
553248	553248	553248	553248	553248	553248	553248	553248	553248	553248	553248	(27)
504665	504665	504665	504665	504665	504665	504665	504665	504665	504665	504665	(28)
144921	144921	144921	144921	144921	144921	144921	144921	144921	144921	144921	(29)
—	—	—	—	—	—	—	—	—	—	—	(30)
—	—	—	—	—	—	—	—	—	—	—	(31)
534296	534296	534296	534296	534296	534296	534296	534296	534296	534296	534296	(32)
516798	516798	555275	516798	555275	516802	516802	555309	555309	555309	516798	(33)
—	—	—	—	—	—	—	—	—	—	—	(34)
—	—	—	—	—	—	—	—	—	—	—	(35)
—	—	—	—	—	552943	552943	—	—	—	—	(36)
554602	554602	554602	554602	554602	562303	562303	554602	554602	554602	554602	(37)
188818	188818	188818	555910	555910	188818	555910	188818	188818	555910	188818	(38)
—	—	—	—	—	562306	562306	—	—	—	—	(39)
554710	554710	554710	554710	554710	554710	554710	554710	554710	554710	554710	(40)
553780	553780	553780	553780	553780	553780	553780	553780	553780	553780	553780	(41)
554354	554354	554354	554354	554354	554354	554354	554354	554354	554354	554354	(42)
—	—	—	—	—	—	—	—	505980	—	—	(43)
516285	516285	—	516285	516285	516285	516285	—	516285	516285	516285	(44)
—	553568	—	—	—	—	—	—	—	—	—	(45)
112201	112201	112201	112201	112201	112201	112201	112201	112201	112201	112201	(46)
137141	137498	137498	137498	137498	137141	137498	137141	137141	137498	137498	(47)
187110	—	—	—	—	187110	—	187110	187110	—	—	(48)
—	—	—	—	—	—	—	—	—	—	54940037	(49)
—	—	—	—	—	—	—	—	—	—	133303	(50)
—	—	—	—	—	—	—	—	—	—	166103	(51)
—	—	—	—	—	—	—	—	—	—	188412	(52)
—	—	—	—	—	—	—	—	—	—	516409	(53)
—	—	—	—	—	—	—	—	—	—	—	(54)
505980	—	—	—	—	—	—	—	—	—	—	(55)
863123	—	—	—	—	—	—	—	863123	—	—	(56)
—	—	—	516805	516805	516805	516805	—	—	516805	—	(57)
—	—	—	—	—	—	—	—	—	—	900288	(58)
—	—	—	—	—	—	—	—	—	—	900269	(59)
517238	516358	516358	516816	516816	516816	516816	516358	517237	516816	—	(60)
312	312	403	166	377	—	—	373	373	373	312	(61)
988	988	988	988	988	988	988	988	988	988	988	(61)

* When ordering, quote part number shown in brackets

† Socket 809795 for plug to be ordered separately

‡ Washer, panel fixing screw

continued



HEADLAMPS WITH AMMETERS AND SWITCHES

DETAILED SPARE PARTS

Part No.	51954A	51954B	*51997B	58015A	58015B	58016A	58016B
Model	MCH61	MCH61	MCH56	MCH61	MCH61	MCH61	MCH61
Replaced by	—	—	(58348)	—	—	—	—
(1) Medallion	397092	397092	—	397092	397092	397092	397092
(2) Bead, panel seating	517066	517066	—	517066	517066	517066	517066
(3) §Ammeter	36084	36084	36084	36084	36084	36084	36084
(4) Ring, rubber, seating	523986	523986	523986	523986	523986	523986	523986
(5) Nut, terminal	166043	166043	166043	166043	166043	166043	166043
(6) Washer, terminal	185040	185040	185040	185040	185040	185040	185040
(7) Switch, lighting	31676	31763	31443	31676	31763	31676	31763
(8) § Handle or knob	351788	351815	318346	351788	351815	351788	351815
(9) Screw, knob fixing	105751	127301	319333	105751	127301	105751	127301
(10) § Washer, knob fixing screw	188408	185038	—	188408	185038	188408	185038
(11) Nut, fixing, front and rear	180114	173777	180670	180114	173777	180114	173777
(12) Washer	187500	188303	—	187500	188303	187500	188303
(13) Rotor, lighting	—	—	313053	—	—	—	—
(14) Base, lighting	—	—	318314	—	—	—	—
(15) Terminal, lighting	—	—	318349	—	—	—	—
(16) Grommet	—	—	318323	—	—	—	—
(17) Rotor, ignition	—	—	313052	—	—	—	—
(18) Terminal, ignition	—	—	318316	—	—	—	—
(19) Cap and plate	—	—	318331	—	—	—	—
(20) Screw, body fixing	—	—	198887	—	—	—	—
(21) Nut, spindle	—	—	169294	—	—	—	—
(22) Shaft, headpiece	351789	351789	—	351789	351789	351789	351789
(23) Roller, contact	351660	351660	—	351660	351660	351660	351660
(24) Plunger, contact	351661	351661	—	351661	351661	351661	351661
(25) Spring, contact plunger	351662	351662	—	351662	351662	351662	351662
(26) § Screw, terminal	120560	120560	120584	120560	120560	120560	120560
(27) Key	—	—	318341	—	—	—	—
(28) Bezel, switch	351768	—	—	351768	—	351768	—
(29) Plate, escutcheon	—	351803	—	—	351803	—	351803
(30) § Rim or door	553248	553248	534343	553248	553248	553248	553248
(31) Wire, fixing	504665	504665	504665	504665	504665	504665	504665
(32) Screw or catch, rim fixing	144921	144921	144921	144921	144921	144921	144921
(33) Plate, rim fixing screw	534296	534296	534296	534296	534296	534296	534296
(34) § Light unit	555309	555309	516828	555309	555309	516798	516798
(35) Backshell	—	—	—	—	—	—	—
(36) Bulb holder, main	554602	554602	554602	554602	554602	554602	554602
(37) Sleeve, terminal	188818	555910	555910	188818	555910	188818	555910
(38) Clip and screw	—	—	—	—	—	—	—
(39) § Bulb holder, pilot	554710	554710	554710	554710	554710	554710	554710
(40) Interior, pilot bulb holder	553780	553780	553780	553780	553780	553780	553780
(41) Ring, bulb holder seating	554354	554354	554354	554354	554354	554354	554354
(42) Bush, cable entry	505980	505980	—	505980	505980	505980	505980
(43) Washer, cable grip, pilot	516285	516285	516285	516285	516285	516285	516285
(44) § Screw, lamp fixing	112201	112201	112201	112201	112201	112201	112201
(45) Washer, lamp fixing screw	137141	137498	137498	137141	137498	137141	137498
(46) Nut, lamp fixing screw	187110	—	—	187110	—	187110	—
(47) § Grommet, cable entry	862217	862217	199005	862217	862217	862217	862217
(48) § Grommet, trip cable	517239	517239	—	517239	517239	517239	517239
(49) Body	517237	517237	517366	517238	517238	517238	517238
(50) § Bulb, main	373	373	312	373	373	312	312
(51) § Bulb, pilot	988	988	988	988	988	988	988

* When ordering, quote part number shown in brackets

§ Recommended spares for stock

HEADLAMPS WITH AMMETERS AND SWITCHES



DETAILED SPARE PARTS

51954 — 58021

	58017A MCH61	58017B MCH61	58018A MCH61	58018B MCH61	58019A MCH61	58019B MCH61	58020A MCH61	58020B MCH61	58021A MCH61	58021B MCH61	
	—	—	—	—	—	—	—	—	—	—	
	397092	397092	397092	397092	397092	397092	397092	397092	397092	397092	(1)
	517066	517066	517066	517066	517066	517066	517066	517066	517066	517066	(2)
	36084	36084	36084	36084	36084	36084	36084	36084	36084	36084	(3)
	523986	523986	523986	523986	523986	523986	523986	523986	523986	523986	(4)
	166043	166043	166043	166043	166043	166043	166043	166043	166043	166043	(5)
	185040	185040	185040	185040	185040	185040	185040	185040	185040	185040	(6)
	31676	31763	31676	31763	31676	31763	31676	31763	31676	31763	(7)
	351788	351815	351788	351815	351788	351815	351788	351815	351788	351815	(8)
	105751	127301	105751	127301	105751	127301	105751	127301	105751	127301	(9)
	188408	185038	188408	185038	188408	185038	188408	185038	188408	185038	(10)
	180114	173777	180114	173777	180114	173777	180114	173777	180114	173777	(11)
	187500	188303	187500	188303	187500	188303	187500	183303	187500	188303	(12)
	—	—	—	—	—	—	—	—	—	—	(13)
	—	—	—	—	—	—	—	—	—	—	(14)
	—	—	—	—	—	—	—	—	—	—	(15)
	—	—	—	—	—	—	—	—	—	—	(16)
	—	—	—	—	—	—	—	—	—	—	(17)
	—	—	—	—	—	—	—	—	—	—	(18)
	—	—	—	—	—	—	—	—	—	—	(19)
	—	—	—	—	—	—	—	—	—	—	(20)
	—	—	—	—	—	—	—	—	—	—	(21)
	351789	351789	351789	351789	351789	351789	351789	351789	351789	351789	(22)
	351660	351660	351660	351660	351660	351660	351660	351660	351660	351660	(23)
	351661	351661	351661	351661	351661	351661	351661	351661	351661	351661	(24)
	351662	351662	351662	351662	351662	351662	351662	351662	351662	351662	(25)
	120560	120560	120560	120560	120560	120560	120560	120560	120560	120560	(26)
	—	—	—	—	—	—	—	—	—	—	(27)
	—	—	—	—	351768	—	351768	—	351768	—	(28)
	351803	351803	—	351803	—	351803	—	351803	—	351803	(29)
	553248	553248	553248	553248	553248	553248	553248	553248	553248	553248	(30)
	504665	504665	504665	504665	504665	504665	504665	504665	504665	504665	(31)
	144921	144921	144921	144921	144921	144921	144921	144921	144921	144921	(32)
	534296	534296	534296	534296	534296	534296	534296	534296	534296	534296	(33)
	555275	555275	516802	516802	516798	516798	555275	555275	516802	516802	(34)
	—	—	552943	552943	—	—	—	—	552943	552943	(35)
	554602	554602	562303	562303	554602	554602	554602	554602	562303	562303	(36)
	188818	555910	188818	555910	188818	555910	188818	555910	188818	555910	(37)
	—	—	562306	562306	—	—	—	—	562306	562306	(38)
	554710	554710	554710	554710	554710	554710	554710	554710	554710	554710	(39)
	553780	553780	553780	553780	553780	553780	553780	553780	553780	553780	(40)
	554354	554354	554354	554354	554354	554354	554354	554354	554354	554354	(41)
	505980	505980	505980	505980	505980	505980	505980	505980	505980	505980	(42)
	516285	516285	516285	516285	516285	516285	516285	516285	516285	516285	(43)
	112201	112201	112201	112201	112201	112201	112201	112201	112201	112201	(44)
	137141	137498	137141	137498	137141	137498	137141	137498	137141	137498	(45)
	187110	—	187110	—	187110	—	187110	—	187110	—	(46)
	862217	862217	862217	862217	862217	862217	862217	862217	862217	862217	(47)
	517239	517239	517239	517239	517239	517239	517239	517239	517239	517239	(48)
	517238	517238	517238	517238	517237	517237	517237	517237	517237	517237	(49)
	403	403	—	—	312	312	403	403	—	—	(50)
	988	988	988	988	988	988	988	988	988	988	(51)



HEADLAMPS WITH AMMETERS AND SWITCHES

DETAILED SPARE PARTS

Part No.	58037A	58091A	58091B	58092A	58092B	58094A	58103A
Model	MCH61	MCH61	MCH61	MCH61	MCH61	MCH56	MCH61
(1) §Ammeter	36184	36084	36084	36084	36084	36084	36084
(2) § Ring, rubber, seating	523986	523986	523986	523986	523986	523986	523986
(3) § Nut, terminal	166043	166043	166043	166043	166043	166043	166043
(4) § Washer, terminal	185040	185040	185040	185040	185040	185040	185040
(5) Bulb holder	365421	—	—	—	—	—	—
(6) § Bulb	998	—	—	—	—	—	—
(7) §Switch, lighting	34080	31676	31763	31676	31673	31443	31676
(8) § Knob	—	351788	351815	351788	351815	†318346	351788
(9) Screw, knob fixing	—	105751	127301	105751	127301	319333	105751
(10) § Washer, knob fixing screw	—	188408	185038	188408	185038	—	188408
(11) § Key	344715	—	—	—	—	318341	—
(12) Cover, ignition cap	344729	—	—	—	—	—	—
(13) § Screw, terminal	120560	120560	120560	120560	120560	120584	120560
(14) Nut, fixing, front and rear	—	180114	173777	180114	173777	180670	180114
(15) Washer	—	187500	188303	187500	188303	—	187500
(16) Shaft, headpiece	—	351789	351789	351789	351789	—	351789
(17) Roller, contact	—	351660	351660	351660	351660	—	351660
(18) Plunger, contact	—	351661	351661	351661	351661	—	351661
(19) Spring, contact plunger	—	351662	351662	351662	351662	—	351662
(20) Grommet	—	—	—	—	—	318323	—
(21) Rotor, lighting	—	—	—	—	—	313053	—
(22) Base, lighting	—	—	—	—	—	318314	—
(23) Terminal, lighting	—	—	—	—	—	318349	—
(24) Rotor, ignition	—	—	—	—	—	313052	—
(25) Terminal, ignition	—	—	—	—	—	318316	—
(26) Cap and plate	—	—	—	—	—	318331	—
(27) Screw, body fixing	—	—	—	—	—	198887	—
(28) Nut, spindle	—	—	—	—	—	169294	—
(29) Plate, escutcheon	—	—	351803	—	351803	—	—
(30) Disc, insulating	—	—	—	—	—	318344	—
(31) Bezel, switch	—	351768	—	351768	—	—	351768
(32) §Rim or door	553248	553248	553248	553248	553248	534343	553248
(33) § Wire, fixing	504665	504665	504665	504665	504665	504665	504665
(34) §Screw, rim fixing	144921	144921	144921	144921	144921	144921	144921
(35) Plate, rim fixing screw	534296	534296	534296	534296	534296	534296	534296
(36) §Light unit	516798	516798	516798	516798	516798	516828	516798
(37) §Bulb holder	554602	554602	554602	554602	554602	554602	554602
(38) §Sleeve, terminal	555910	188818	555910	188818	555910	555910	188818
(39) §Bulb holder, pilot	554710	554710	554710	554710	554710	554710	554710
(40) § Interior, bulb holder	553780	553780	553780	553780	553780	553780	553780
(41) § Ring, bulb holder seating	554354	554354	554354	554354	554354	554354	554354
(42) §Bush, cable entry	505980	505980	505980	505980	505980	—	505980
(43) Washer, cable grip	516285	516285	516285	516285	516285	516285	516285
(44) §Screw, lamp fixing	112201	112201	112201	112201	112201	112201	112201
(45) Washer, lamp fixing screw	137498	137141	137498	137141	137498	137498	137141
(46) Nut, lamp fixing screw	—	187110	—	187110	—	—	187110
(47) §Grommet, cable entry	862217	862217	862217	862217	862217	—	862217
(48) §Grommet, trip cable	517239	517239	517239	517239	517239	—	517239
(49) Medallion	397106	397106	397106	397106	397106	—	397092
(50) Gasket, medallion	517066	517066	517066	517066	517066	—	517066
(51) Body	517241	517242	517242	517243	517243	517513	517247
(52) §Bulb, main	312	312	312	312	312	312	312
(53) §Bulb, pilot	988	988	988	988	988	988	988

† Order separately § Recommended spares for stock

HEADLAMPS WITH AMMETERS AND SWITCHES



DETAILED SPARE PARTS

58037 — 58126

58103B MCH61	58104A MCH61	58104B MCH61	58111A MCH56	58112A MCH56	58124A MCH61	58124B/D MCH61	58125A MCH61	58125B MCH61	58126A MCH61	
36084	36084	36084	—	36084	36084	36084	36084	36084	36084	(1)
523986	523986	523986	—	523986	523986	523986	523986	523986	523986	(2)
166043	166043	166043	—	166043	166043	166043	166043	166043	166043	(3)
185040	185040	185040	—	185040	185040	185040	185040	185040	185040	(4)
—	—	—	—	—	—	—	—	—	—	(5)
—	—	—	—	—	—	—	—	—	—	(6)
31763	31676	31763	31721	31718	31443	31443	31443	31443	31443	(7)
351815	351788	351815	351815	351815	†318346	†318346	†318346	†318346	†318346	(8)
127301	105751	127301	127301	127301	319333	319333	319333	319333	319333	(9)
185038	188408	185038	185038	185038	—	—	—	—	—	(10)
—	—	—	—	—	318341	318341	318341	318341	318341	(11)
—	—	—	—	—	—	—	—	—	—	(12)
120560	120560	120560	120560	120560	120584	120584	120584	120584	120584	(13)
173777	180114	173777	173777	173777	180670	180670	180670	180670	180670	(14)
188303	187500	188303	188303	188303	—	—	—	—	—	(15)
351789	351789	351789	351821	351789	—	—	—	—	—	(16)
351660	351660	351660	351660	351660	—	—	—	—	—	(17)
351661	351661	351661	351661	351661	—	—	—	—	—	(18)
351662	351662	351662	351662	351662	—	—	—	—	—	(19)
—	—	—	—	—	318323	318323	318323	318323	318323	(20)
—	—	—	—	—	313053	313053	313053	313053	313053	(21)
—	—	—	—	—	318314	318134	318314	318314	318314	(22)
—	—	—	—	—	318349	318349	318349	318349	318349	(23)
—	—	—	—	—	313052	313052	313052	313052	313052	(24)
—	—	—	—	—	318316	318316	318316	318316	318316	(25)
—	—	—	—	—	318331	318331	318331	318331	318331	(26)
—	—	—	—	—	198887	198887	198887	198887	198887	(27)
—	—	—	—	—	169294	169294	169294	169294	169294	(28)
351803	—	351803	351803	351803	318942	318942	318942	318942	318942	(29)
—	—	—	—	—	—	318344	—	318344	—	(30)
—	351768	—	—	—	—	—	—	—	—	(31)
553248	553248	553248	534343	534343	553248	553248	553248	553248	553248	(32)
504665	504665	504665	504665	504665	504665	504665	504665	504665	504665	(33)
144921	144921	144921	144921	144921	144921	144921	144921	144921	144921	(34)
534296	534296	534296	534296	534296	534296	534296	534296	534296	534296	(35)
516798	516798	516798	516828	516828	555309	555309	516798	516798	555275	(36)
554602	554602	554602	554602	554602	554602	554602	554602	554602	554602	(37)
555910	188818	555910	555910	555910	188818	555910	188818	555910	188818	(38)
554710	554710	554710	554710	554710	554710	554710	554710	554710	554710	(39)
553780	553780	553780	553780	553780	553780	553780	553780	553780	553780	(40)
554354	554354	554354	554354	554354	554354	554354	554354	554354	554354	(41)
505980	505980	505980	—	—	505980	505980	505980	505980	505980	(42)
516285	516285	516285	516285	516285	516285	516285	516285	516285	516285	(43)
112201	112201	112201	112201	112201	112201	112201	112201	112201	112201	(44)
137498	137141	137498	137498	137498	137498	137498	137498	137498	137498	(45)
—	187110	—	—	—	—	—	—	—	—	(46)
862217	862217	862217	862217	862217	862217	862217	862217	862217	862217	(47)
517239	517239	517239	199005	199005	517239	517239	517239	517239	517239	(48)
397092	397092	397092	—	—	397092	397092	397092	397092	397092	(49)
517066	517066	517066	—	—	517066	517066	517066	517066	517066	(50)
517247	517248	517248	517515	517516	517237	517237	517237	517237	517237	(51)
312	312	312	312	166	373	373	312	312	403	(52)
988	988	988	996	988	988	988	988	988	988	(53)

† Order separately



HEADLAMPS WITH AMMETERS AND SWITCHES

DETAILED SPARE PARTS

Part No.	58126B MCH61	58127A MCH61EF	58127B MCH61EF	58135A MCH57P	58136A MCH57P	58137A MCH57P	58138A MCH57P/ EF
(1) §Ammeter	36084	36084	36084	36084	36084	36084	36084
(2) § Ring, rubber, seating	523986	523986	523986	523986	523986	523986	523986
(3) § Nut, terminal	166043	166043	166043	166043	166043	166043	166043
(4) § Washer, terminal	185040	185040	185040	185040	185040	185040	185040
(5) §Switch, lighting	31443	31443	31443	31443	31443	31443	31443
(6) § Knob or handle	†318346	†318346	†318346	†318346	†318346	†318346	†318346
(7) Screw, knob fixing	319333	319333	319333	319333	319333	319333	319333
(8) Washer, knob fixing screw	—	—	—	—	—	—	—
(9) § Key	318341	318341	318341	318341	318341	318341	318341
(10) § Screw, terminal	120584	120584	120584	120584	120584	120584	120584
(11) Nut, fixing, front and rear	180670	180670	180670	180670	180670	180670	180670
(12) Washer, fixing nut	—	—	—	—	—	—	—
(13) Shaft, headpiece	—	—	—	—	—	—	—
(14) Roller, contact	—	—	—	—	—	—	—
(15) Plunger, contact	—	—	—	—	—	—	—
(16) Spring, contact plunger	—	—	—	—	—	—	—
(17) Grommet	318323	318323	318323	318323	318323	318323	318323
(18) Rotor, lighting	313053	313053	313053	313053	313053	313053	313053
(19) Base, lighting	318314	318314	318314	318314	318314	318314	318314
(20) Terminal, lighting	318349	318349	318349	318349	318349	318349	318349
(21) Rotor, ignition	313052	313052	313052	313052	313052	313052	313052
(22) Terminal, ignition	318316	318316	318316	318316	318316	318316	318316
(23) Cap and plate	318331	318331	318331	318331	318331	318331	318331
(24) Screw, body fixing	198887	198887	198887	198887	198887	198887	198887
(25) Nut, spindle or contact stud	169294	169294	169294	169294	169294	169294	169294
(26) Plate, escutcheon	318942	318942	318942	318942	318942	318942	318942
(27) Disc, insulating	318344	—	318344	318344	318344	318344	318344
(28) §Rim or door	553248	553248	553248	553248	553248	553248	553248
(29) § Wire, fixing	504665	504665	504665	504665	504665	504665	504665
(30) §Screw, rim fixing	144921	144921	144921	144921	144921	144921	144921
(31) Plate, rim fixing screw	534296	534296	534296	554408	554408	554408	554408
(32) §Light unit	555275	516802	516802	555309	516798	555275	516802
(33) §Backshell	—	552943	552943	—	—	—	552943
(34) § Bulb holder	554602	562303	562303	554602	554602	554602	562303
(35) Clip and screw or spring	—	562306	562306	—	—	—	562306
(36) § Sleeve, terminal	555910	188818	555910	555910	555910	555910	555910
(37) §Bulb holder, pilot	554710	554710	554710	554710	554710	554710	554710
(38) § Interior, bulb holder	553780	553780	553780	553780	553780	553780	553780
(39) § Ring, bulb holder seating	554354	554354	554354	554354	554354	554354	554354
(40) §Bush, cable entry	505980	505980	505980	—	—	—	—
(41) Washer, cable grip	516285	516285	516285	516285	516285	516285	516285
(42) §Screw, lamp fixing	112201	112201	112201	112201	112201	112201	112201
(43) Washer, lamp fixing screw	137498	137498	137498	137498	137498	137498	137498
(44) Nut, fixing, top shell to bottom shell	—	—	—	177014	177014	177014	177014
(45) Screw, fixing, top shell to fixing ring	—	—	—	572261	572261	572261	572261
(46) Nut, top shell screw	—	—	—	166103	166103	166103	166103
(47) Washer, top shell screw	—	—	—	188412	188412	188412	188412
(48) Washer, fixing nut	—	—	—	188329	188329	188329	188329
(49) Top shell	—	—	—	516972	516972	516972	516972
(50) Bottom shell	—	—	—	516973	516973	516973	516973
(51) §Grommet, cable entry	862217	862217	862217	—	—	—	—
(52) §Grommet, trip cable	517239	517239	517239	—	—	—	—
(53) §Grommet, body	—	—	—	—	—	—	—
(54) Medallion	397092	397092	397092	—	—	—	—
(55) Gasket, medallion	517066	517066	517066	—	—	—	—
(56) Body	517237	517237	517237	—	—	—	—
(57) §Bulb, main	403	—	—	373	312	403	—
(58) §Bulb, pilot	988	988	988	988	988	988	988

† Order separately § Recommended spares for stock

HEADLAMPS WITH AMMETERS AND SWITCHES



DETAILED SPARE PARTS

58126—58156

58147A MCH52	58149A MCH56	58150A MCH56	58151A MCH57P	58152A MCH57P	58153A MCH57P	58154A MCH57P/ EF	58155A MCH52	58156A MCH61	58156B MCH61	
36084	—	36084	36084	36084	36084	36084	36084	36084	36084	(1)
523986	—	523986	523986	523986	523986	523986	523986	523986	523986	(2)
166043	—	166043	166043	166043	166043	166043	166043	166043	166043	(3)
185040	—	185040	185040	185040	185040	185040	185040	185040	185040	(4)
—	31721	31718	31763	31763	31763	31763	—	31443	31443	(5)
—	351815	351815	351815	351815	351815	351815	—	†318346	†318346	(16)
—	127301	127301	127301	127301	127301	127301	—	319333	319333	(7)
—	185038	185038	185038	185038	185038	185038	—	—	—	(8)
—	—	—	—	—	—	—	—	318341	318341	(9)
—	120560	120560	120560	120560	120560	120560	—	120584	120584	(10)
—	173777	173777	173777	173777	173777	173777	—	180670	180670	(11)
—	188303	188303	188303	188303	188303	188303	—	—	—	(12)
—	351821	351789	351789	351789	351789	351789	—	—	—	(13)
—	351660	351660	351660	351660	351660	351660	—	—	—	(14)
—	351661	351661	351661	351661	351661	351661	—	—	—	(15)
—	351662	351662	351662	351662	351662	351662	—	—	—	(16)
—	—	—	—	—	—	—	—	318323	318323	(17)
—	—	—	—	—	—	—	—	313053	313053	(18)
—	—	—	—	—	—	—	—	318314	318314	(19)
—	—	—	—	—	—	—	—	318349	318349	(20)
—	—	—	—	—	—	—	—	313052	313052	(21)
—	—	—	—	—	—	—	—	318316	318316	(22)
—	—	—	—	—	—	—	—	318331	318331	(23)
—	—	—	—	—	—	—	—	198887	198887	(24)
—	—	—	—	—	—	—	—	169294	169294	(25)
—	351803	351803	351803	351803	351803	351803	—	318942	318942	(26)
—	—	—	—	—	—	—	—	—	318344	(27)
553248	534343	534343	553248	553248	553248	553248	553248	553248	553248	(28)
504665	504665	504665	504665	504665	504665	504665	504665	504665	504665	(29)
144921	144921	144921	144921	144921	144921	144921	144921	144921	144921	(30)
534296	534296	534296	554408	554408	554408	554408	534296	534296	534296	(31)
516798	516828	516828	555309	516798	555275	516802	—	516798	516798	(32)
—	—	—	—	—	—	552943	—	—	—	(33)
554602	554602	554602	554602	554602	554602	562303	—	554602	554602	(34)
—	—	—	—	—	—	562306	—	—	—	(35)
555910	555910	555910	555910	555910	555910	555910	—	188818	555910	(36)
554710	554710	554710	554710	554710	554710	554710	—	554710	554710	(37)
553780	553780	553780	553780	553780	553780	553780	—	553780	553780	(38)
554354	554354	554354	554354	554354	554354	554354	—	554354	554354	(39)
—	—	—	—	—	—	—	—	505980	505980	(40)
516285	516285	516285	516285	516285	516285	516285	—	516285	516285	(41)
112201	112201	112201	112201	112201	112201	112201	112201	112201	112201	(42)
137498	137498	137498	137498	137498	137498	137498	137498	137498	137498	(43)
—	—	—	177014	177014	177014	177014	—	—	—	(44)
—	—	—	572261	572261	572261	572261	—	—	—	(45)
—	—	—	166103	166103	166103	166103	—	—	—	(46)
—	—	—	188412	188412	188412	188412	—	—	—	(47)
—	—	—	188329	188329	188329	188329	—	—	—	(48)
—	—	—	516972	516972	516972	516972	—	—	—	(49)
—	—	—	516973	516973	516973	516973	—	—	—	(50)
—	862217	862217	—	—	—	—	—	862217	862217	(51)
—	—	—	—	—	—	—	—	517239	517239	(52)
516805	199005	199005	—	—	—	—	516805	—	—	(53)
—	—	—	—	—	—	—	—	397092	397092	(54)
—	—	—	—	—	—	—	—	517066	517066	(55)
516817	517518	517519	—	—	—	—	516817	517247	517247	(56)
166	312	166	373	312	403	—	—	312	312	(57)
988	996	988	988	988	988	988	—	988	988	(58)

Order separately



HEADLAMPS WITH AMMETERS AND SWITCHES

DETAILED SPARE PARTS

Part No.	58157A	58157B	58162A	58169A	58170A	58171A	58172A
Model	MCH61	MCH61	MCH56	SSU700P	SSU700P	SSU700P	SSU700P/EF
Replaced by	—	—	—	—	—	—	—
(1) Instrument panel	—	—	—	517126	517126	517126	517126
(2) Screw, panel fixing	—	—	—	186130	186130	186130	186130
(3) § Ammeter	36084	36084	36084	36084	36084	36084	36084
(4) § Ring, rubber, seating	523986	523986	523986	523986	523986	523986	523986
(5) § Nut, terminal	166043	166043	166043	166043	166043	166043	166043
(6) § Washer, terminal	185040	185040	185040	185040	185040	185040	185040
(7) § Switch, lighting	31443	31443	31758	31763	31763	31763	31763
(8) § Knob or handle	†318346	†318346	351815	351815	351815	351815	351815
(9) Screw, knob fixing	319333	319333	127301	127301	127301	127301	127301
(10) Washer, knob fixing screw	—	—	185038	185038	185038	185038	185038
(11) § Key	318341	318341	—	—	—	—	—
(12) § Screw, terminal	120584	120584	120560	120560	120560	120560	120560
(13) Nut, fixing, front and rear	180670	180670	173777	173777	173777	173777	173777
(14) Washer, fixing nut	—	—	188303	188303	188303	188303	188303
(15) Spring, switch fixing	—	—	—	—	—	—	—
(16) Shaft, headpiece	—	—	351824	351789	351789	351789	351789
(17) Roller, contact	—	—	351660	351660	351660	351660	351660
(18) Plunger, contact	—	—	351661	351661	351661	351661	351661
(19) Spring, contact plunger	—	—	351662	351662	351662	351662	351662
(20) Grommet	318323	318323	—	—	—	—	—
(21) Rotor, lighting	313053	313053	—	—	—	—	—
(22) Base, lighting	318314	318314	—	—	—	—	—
(23) Terminal, lighting	318349	318349	—	—	—	—	—
(24) Rotor, ignition	313052	313052	—	—	—	—	—
(25) Terminal, ignition	318316	318316	—	—	—	—	—
(26) Cap and plate	318331	318331	—	—	—	—	—
(27) Screw, body fixing	198887	198887	—	—	—	—	—
(28) Nut, spindle or contact stud	169294	169294	—	—	—	—	—
(29) Lever, contact	—	—	351528	—	—	—	—
(30) § Switch, dip	—	—	—	—	—	—	—
(31) Nut, fixing	—	—	—	—	—	—	—
(32) Screw, terminal	—	—	—	—	—	—	—
(33) Screw, cable clip	—	—	—	186128	186128	186128	186128
(34) Washer, cable clip screw	—	—	—	188412	188412	188412	188412
(35) Plate, escutcheon	318942	318942	351803	351803	351803	351803	351803
(36) Disc, insulating	—	318344	—	—	—	—	—
(37) Bezel, switch	—	—	—	—	—	—	—
(38) § Rim or door	553248	553248	534343	553248	553248	553248	553248
(39) § Wire, fixing	504665	504665	504665	504665	504665	504665	504665
(40) § Screw, rim fixing	144921	144921	144921	144921	144921	144921	144921
(41) Plate, rim fixing screw	534296	534296	534296	534296	534296	534296	534296
(42) § Light unit	516798	516798	516828	555309	516798	555275	516802
(43) § Backshell	—	—	—	—	—	—	552943
(44) § Bulb holder, main	554602	554602	554602	554602	554602	554602	562303
(45) Clip and screw or spring	—	—	—	—	—	—	562306
(46) § Sleeve, terminal	188818	555910	555910	188818	188818	188818	188818
(47) § Bulb holder, pilot	554710	554710	554710	554710	554710	554710	554710
(48) § Interior, bulb holder	553780	553780	553780	553780	553780	553780	553780
(49) § Ring, bulb holder seating	554354	554354	554354	554354	554354	554354	554354
(50) § Bush, rubber, cable entry	505980	505980	—	—	—	—	—
(51) Washer, cable grip	516285	516285	516285	—	—	—	—
(52) Screw, lamp fixing	112201	112201	112201	112201	112201	112201	112201
(53) Washer, lamp fixing screw	137498	137498	137498	137141	137141	137141	137141
(54) Nut, lamp fixing screw	—	—	—	187110	187110	187110	187110
(55) Nut, top shell to bottom shell fixing	—	—	—	—	—	—	—
(56) Screw, top shell to fixing ring	—	—	—	—	—	—	—
(57) Nut, top shell screw	—	—	—	—	—	—	—
(58) Washer, top shell screw	—	—	—	—	—	—	—
(59) Washer, fixing nut	—	—	—	—	—	—	—
(60) Top shell	—	—	—	—	—	—	—
(61) Bottom shell	—	—	—	—	—	—	—
(62) § Grommet, cable entry	862217	862217	862217	—	—	—	—
(63) § Grommet, trip cable	517239	517239	—	—	—	—	—
(64) § Grommet, body	—	—	199005	—	—	—	—
(65) Medallion	397092	397092	—	—	—	—	—
(66) Gasket, medallion	517066	517066	—	—	—	—	—
(67) Body	517248	517248	517514	516356	516356	516356	516356
(68) § Connector, single	—	—	—	—	—	—	—
(69) Plug and cable	—	—	—	—	—	—	—
(70) § Screw, plug fixing	—	—	—	—	—	—	—
(71) Nut, plug fixing screw	—	—	—	—	—	—	—
(72) Washer, plug fixing screw	—	—	—	—	—	—	—
(73) Ring, plug retaining	—	—	—	—	—	—	—
(74) § Bulb, main	312	312	312	373	312	403	—
(75) § Bulb, pilot	988	988	988	988	988	988	988

† Order separately § Recommended spares for stock

HEADLAMPS WITH AMMETERS AND SWITCHES



DETAILED SPARE PARTS

58157 — 58210

58174A MCH56 —	58177A MCH57P —	58178A MCH57P —	58179A MCH57P —	58180A MCH57P/EF —	58197A MCH61 —	58198B MCH62 —	58208B/D SSU700P —	*58209B/D SSU700P (58224)	58210B/D SSU700P —
—	—	—	—	—	—	—	517126	517126	517126 (1)
—	—	—	—	—	—	—	186130	186130	186130 (2)
36084	36084	36084	36084	36084	36084	—	36084	36084	36084 (3)
523986	523986	523986	523986	523986	523986	—	523986	523986	523986 (4)
166043	166043	166043	166043	166043	166043	—	166043	166043	166043 (5)
185040	185040	185040	185040	185040	185040	—	185040	185040	185040 (6)
31758	31340	31340	31340	31340	31443	31777	31763	31763	31763 (7)
351788	351567	351567	351567	351567	+318346	351788	351815	351815	351815 (8)
105751	126544	126544	126544	126544	319333	105751	127301	127301	127301 (9)
188408	188408	188408	188408	188408	—	188408	185038	185038	185038 (10)
—	—	—	—	—	318341	—	—	—	— (11)
120560	120560	120560	120560	120560	120584	120560	120560	120560	120560 (12)
180114	—	—	—	—	180670	180114	173777	173777	173777 (13)
187500	—	—	—	—	—	187500	188303	188303	188303 (14)
—	308234	—	—	—	—	—	—	—	— (15)
351789	351501	351501	351501	351501	—	351794	351789	351789	351789 (16)
351660	351660	351660	351660	351660	—	351660	351660	351660	351660 (17)
351661	351661	351661	351661	351661	—	351661	351661	351661	351661 (18)
351662	351662	351662	351662	351662	—	351662	351662	351662	351662 (19)
—	—	—	—	—	318323	—	—	—	— (20)
—	—	—	—	—	313053	—	—	—	— (21)
—	—	—	—	—	318314	—	—	—	— (22)
—	—	—	—	—	318349	—	—	—	— (23)
—	—	—	—	—	313052	—	—	—	— (24)
—	—	—	—	—	318316	—	—	—	— (25)
—	—	—	—	—	318331	—	—	—	— (26)
—	—	—	—	—	198887	—	—	—	— (27)
—	166103	166103	166103	166103	169294	—	—	—	— (28)
—	—	—	—	—	—	351528	—	—	— (29)
—	—	—	—	—	—	31620	—	—	— (30)
—	—	—	—	—	—	314540	—	—	— (31)
—	—	—	—	—	—	120560	—	—	— (32)
—	—	—	—	—	—	—	186128	186128	186128 (33)
—	—	—	—	—	—	—	188412	188412	188412 (34)
—	—	—	—	—	318942	—	351803	351803	351803 (35)
—	—	—	—	—	318344	—	—	—	— (36)
—	—	—	—	—	—	—	—	—	— (37)
351768	—	—	—	—	—	—	—	—	— (38)
534343	553248	553248	553248	553248	553248	517187	553248	553248	553248 (38)
504665	504665	504665	504665	504665	504665	—	504665	504665	504665 (39)
144921	144921	144921	144921	144921	144921	144921	144921	144921	144921 (40)
534296	554408	554408	554408	554408	534296	534296	534296	534296	534296 (41)
516828	555309	516798	555275	516802	516798	+517205	516798	555275	555309 (42)
—	—	—	—	552943	—	656105	—	—	— (43)
554602	554602	554602	554602	562303	554602	656132	554602	554602	554602 (44)
—	—	—	—	562306	—	656125	—	—	— (45)
555910	555910	555910	555910	555910	555910	188152	555910	555910	555910 (46)
554710	554710	554710	554710	554710	554710	656039	554710	554710	554710 (47)
554780	553780	553780	553780	553780	553780	—	553780	553780	553780 (48)
554354	554354	554354	554354	554354	554354	—	554354	554354	554354 (49)
—	—	—	—	—	505980	—	—	—	— (50)
516285	516285	516285	516285	516285	516285	—	516285	516285	516285 (51)
112201	112201	112201	112201	112201	112201	112756	112201	112201	112201 (52)
137498	137498	137498	137498	137498	137498	137497	137498	137498	137498 (53)
—	—	—	—	—	—	187110	—	—	— (54)
—	177014	177014	177014	177014	—	—	—	—	— (55)
—	572261	572261	572261	572261	—	*186136	—	—	— (56)
—	166103	166103	166103	166103	—	—	—	—	— (57)
—	188412	188412	188412	188412	—	128433	—	—	— (58)
—	188329	188329	188329	188329	—	—	—	—	— (59)
—	516951	516951	516951	516951	—	—	—	—	— (60)
—	516973	516973	516973	516973	—	—	—	—	— (61)
862217	—	—	—	—	862217	862217	—	—	— (62)
—	—	—	—	—	517239	—	—	—	— (63)
199005	—	—	—	—	—	199001	—	—	— (64)
—	—	—	—	—	397092	—	—	—	— (65)
—	—	—	—	—	517066	—	—	—	— (66)
517521	—	—	—	—	517238	§656118	—	—	— (66)
—	—	—	—	—	—	517209	54520009	54520009	54520009 (67)
—	—	—	—	—	—	—	900288	900288	900288 (68)
—	—	—	—	—	—	—	54941699	54941768	54941768 (69)
—	—	—	—	—	—	—	133303	133303	133303 (70)
—	—	—	—	—	—	—	166103	166103	166103 (71)
—	—	—	—	—	—	—	188412	188412	188412 (72)
—	—	—	—	—	—	—	516409	516409	516409 (73)
312	373	312	403	—	312	387	312	403	373 (74)
988	988	988	988	988	988	974	988	988	988 (75)

* When ordering, quote part number shown in brackets
§ Lens gasket

† Order separately

‡ Reflector

|| Lens

¶ Screw, reflector fixing



HEADLAMPS WITH AMMETERS AND SWITCHES

DETAILED SPARE PARTS

Part No.	58211B/D	58215A	58216A	58224B/D	58241A/B	58259A	58339A
Model	SSU700PEP	MCH56	MCH56	SSU700P	MCH61	MCH56	MCH56
(1) Instrument panel	517126	—	—	517126	—	—	—
(2) Screw, panel fixing	186130	—	—	186130	—	—	—
(3) Ammeter	36084	36084	36084	36084	36084	36084	36084
(4) Ring, rubber, seating	523986	523986	523986	523986	523986	523986	523986
(5) Nut, terminal	166043	166043	166043	166043	166043	166043	166043
(6) Washer, terminal	185040	185040	185040	185040	185040	185040	185040
(7) Switch, lighting	31763	31758	31758	31763	31784	31443	31443
(8) Knob, with screw	351815	351815	351815	351815	351815	318346	318346
(9) Screw, knob fixing	127301	127301	127301	127301	127301	319333	319333
(10) Washer, knob fixing screw	185038	185038	185038	185038	185038	—	—
(11) Key	—	—	—	—	—	318341	318341
(12) Screw, terminal	120560	120560	120560	120560	120560	120584	120584
(13) Nut, fixing	173777	173777	173777	173777	173777	180670	180670
(14) Washer	188303	188303	188303	188303	188303	—	—
(15) Washer, spring	—	—	—	—	—	—	—
(16) Shaft, headpiece	351789	351824	351824	351789	54330517	—	—
(17) Roller, contact	351660	351660	351660	351660	351660	—	—
(18) Plunger, contact	351661	351661	351661	351661	351661	—	—
(19) Spring, contact plunger	351662	351662	351662	351662	351662	—	—
(20) Grommet	—	—	—	—	—	318323	318323
(21) Rotor, lighting	—	—	—	—	—	313053	313053
(22) Base, lighting	—	—	—	—	—	318314	318314
(23) Terminal, lighting	—	—	—	—	—	318349	318349
(24) Rotor, ignition	—	—	—	—	—	313052	313052
(25) Terminal, ignition	—	—	—	—	—	318316	318316
(26) Cap and plate	—	—	—	—	—	318331	318331
(27) Screw, body fixing	—	—	—	—	—	198887	198887
(28) Nut, spindle	—	—	—	—	—	169294	169294
(29) Lever, contact	—	351528	351528	—	351528	—	—
(30) Connector, snap	—	—	—	—	—	—	—
(31) Connector, tube, single	—	—	—	—	—	—	—
(32) Connector, tube, double	—	—	—	—	—	—	—
(33) Cover, rubber	—	—	—	—	—	—	—
(34) Switch, dip	—	—	—	—	—	—	—
(35) Nut, fixing	—	—	—	—	—	—	—
(36) Screw, terminal	—	—	—	—	—	—	—
(37) Switch, ignition	—	—	—	—	—	—	—
(38) Connector, snap	—	—	—	—	—	—	—
(39) Connector, tube, single	—	—	—	—	—	—	—
(40) Connector, tube, double	—	—	—	—	—	—	—
(41) Cover, rubber	—	—	—	—	—	—	—
(42) Knob, with screw	—	—	—	—	—	—	—
(43) Screw, knob fixing	—	—	—	—	—	—	—
(44) Washer, dished, fixing screw	—	—	—	—	—	—	—
(45) Screw, cable clip	186128	—	—	186128	—	—	—
(46) Washer, cable clip screw	188412	—	—	188412	—	—	—
(47) Plate, escutcheon	351803	351803	351803	351803	351803	351803	351803
(48) Disc, insulating	—	—	—	—	—	318344	318344
(49) Rim or door	553248	534343	534343	553248	553248	534343	534343
(50) Wire, fixing	504665	504665	504665	504665	504665	504665	504665
(51) Screw, rim fixing	144921	144921	144921	144921	144921	144921	144921
(52) Plate, rim fixing screw	534296	534296	534296	534296	534296	534296	534296
(53) Light unit	516802	516828	516828	516798	516798	516828	516828
(54) Backshell	552943	—	—	—	—	—	—
(55) Bulb holder	562303	554602	554602	554602	554602	554602	554602
(56) Clip and screw	562306	—	—	—	—	—	—
(57) Sleeve, terminal	555910	555910	555910	555910	555910	555910	555910
(58) Bulb holder, pilot	554710	554710	554710	554710	554710	554710	554710
(59) Interior, bulb holder	553780	553780	553780	553780	553780	553780	553780
(60) Ring, bulb holder, seating	554354	554354	554354	554354	554354	554354	554354
(61) Bush, rubber, cable entry	—	—	—	—	505980	—	—
(62) Washer, cable grip	516285	516285	516285	516285	516285	516285	516285
(63) Screw, lamp fixing	112201	112201	112201	112201	112201	112201	112201
(64) Washer, lamp fixing screw	137498	137498	137498	137498	137498	137498	137498
(65) Screw, cable clip	—	—	—	186157	—	—	—
(66) Nut, fixing, top shell to bottom shell	—	—	—	—	—	—	—
(67) Screw, fixing, top shell to fixing ring	—	—	—	—	—	—	—
(68) Nut, top shell screw	—	—	—	—	—	—	—
(69) Washer, top shell screw	—	—	—	—	—	—	—
(70) Washer, fixing nut	—	—	—	—	—	—	—
(71) Top shell	—	—	—	—	—	—	—
(72) Bottom shell	—	—	—	—	—	—	—
(73) Grommet, cable entry	—	199005	199005	—	862217	199005	—
(74) Grommet, trip cable	—	—	—	—	517239	—	—
(75) Grommet, body	—	862217	862217	—	—	862217	—
(76) Medallion	—	—	—	—	397092	—	—
(77) Gasket, medallion	—	—	—	—	517066	—	—
(78) Connector, single	900288	—	—	900288	—	—	—
(79) Plug and cable	54941768	—	—	54941768	—	—	—
(80) Screw, plug fixing	133303	—	—	133303	—	—	—
(81) Nut, screw plug fixing	166103	—	—	166103	—	—	—
(82) Washer, plug fixing screw	188412	—	—	188412	—	—	—
(83) Ring, plug retaining	516409	—	—	516409	—	—	—
(84) Stud, warning light	—	—	—	—	—	—	—
(85) Body	54520009	517519	517516	54520009	517238	517519	54520246
(86) Bulb, main	—	312	312	—	312	312	54520340
(87) Bulb, pilot	988	988	988	988	988	988	988

† Order separately § Recommended spares for stock

HEADLAMPS WITH AMMETERS AND SWITCHES



DETAILED SPARE PARTS

58211 — 58470

58348A MCH56	58349A MCH56	58354B MCH57P	58374A/B MCH61	58395A/E MCH66	58404A MCH61	58409A MCH61	58432A MCH61	58442A MCH61	58470A MCH56	
---	---	---	---	---	---	---	---	---	---	(1)
---	---	---	---	---	---	---	---	---	---	(2)
36084	36084	36084	36084	---	36084	36084	36084	36084	36084	(3)
523986	523986	523986	523986	---	523986	523986	523986	523986	523986	(4)
166043	166043	166043	166043	---	166043	166043	166043	166043	166043	(5)
185040	185040	185040	185040	---	185040	185040	185040	185040	185040	(6)
31443	31443	31443	31443	31356	31443	54033109	54033028	31784	31784	(7)
†318346	†318346	†318346	†318346	---	†318346	†54330934	†54330934	351815	351815	(8)
319333	319333	319333	319333	---	319333	101371	101371	127301	127301	(9)
---	---	---	---	---	---	332529	332529	185038	185038	(10)
318341	318341	318341	318341	---	---	---	---	---	---	(11)
120584	120584	120584	120584	121610	---	---	---	120560	120560	(12)
180670	180670	180670	180670	180670	---	---	---	173777	173777	(13)
---	---	---	---	158350	---	---	---	188303	188303	(14)
---	---	---	---	185188	---	---	---	---	---	(15)
---	---	---	---	---	---	---	---	54330517	54330517	(16)
---	---	---	---	---	---	---	---	351660	351660	(17)
---	---	---	---	---	---	---	---	351661	351661	(18)
---	---	---	---	---	---	---	---	351662	351662	(19)
318323	318323	318323	318323	---	---	---	---	---	---	(20)
313053	313053	313053	313053	---	---	---	---	---	---	(21)
318314	318314	318314	318314	---	---	---	---	---	---	(22)
318349	318349	318349	318349	---	---	---	---	---	---	(23)
313052	313052	313052	313052	---	---	---	---	---	---	(24)
318316	318316	318316	318316	---	---	---	---	---	---	(25)
318331	318331	318331	318331	---	---	---	---	---	---	(26)
198887	198887	198887	198887	---	---	---	---	---	---	(27)
169294	169294	169294	169294	---	---	---	---	---	---	(28)
---	---	---	---	---	---	---	---	351528	351528	(29)
---	---	---	---	---	---	900269	900269	---	---	(30)
---	---	---	---	---	---	900288	900288	---	---	(31)
---	---	---	---	---	---	---	850641	---	---	(32)
---	---	---	---	---	---	---	332521	332521	---	(33)
---	---	---	---	31620	---	---	---	---	---	(34)
---	---	---	---	314540	---	---	---	---	---	(35)
---	---	---	---	120560	---	---	---	---	---	(36)
---	---	---	---	---	---	---	---	---	---	(37)
---	---	---	---	---	---	54033027	54033026	---	---	(38)
---	---	---	---	---	---	900269	900269	---	---	(39)
---	---	---	---	---	---	900288	900288	---	---	(40)
---	---	---	---	---	---	850641	---	---	---	(41)
---	---	---	---	---	---	332521	332521	---	---	(42)
---	---	---	---	---	---	54332498	54332498	---	---	(43)
---	---	---	---	---	---	101371	101371	---	---	(44)
---	---	---	---	---	---	332529	332529	---	---	(45)
---	---	---	---	---	---	---	---	---	---	(46)
---	---	318942	318942	---	---	---	---	351803	351803	(47)
318344	318344	318344	318344	---	318344	---	---	---	---	(48)
534343	534343	534343	534343	534343	534343	534343	534343	534343	534343	(49)
504665	504665	504665	504665	504665	504665	504665	504665	504665	504665	(50)
144921	144921	144921	144921	144921	144921	144921	144921	144921	144921	(51)
534296	534296	534296	534296	534296	534296	534296	534296	534296	534296	(52)
516828	516828	516798	555309	54520452	516798	516798	516798	516798	516828	(53)
---	---	---	---	---	---	---	---	---	---	(54)
554602	554602	554602	554602	554602	554602	554602	554602	554602	554602	(55)
---	---	---	---	---	---	---	---	---	---	(56)
555910	555910	555910	555910	555910	555910	555910	555910	555910	555910	(57)
554710	554710	554710	554710	---	554710	554710	554710	554710	554710	(58)
553780	553780	553780	553780	---	553780	553780	553780	553780	553780	(59)
554354	554354	554354	554354	---	554354	554354	554354	554354	554354	(60)
---	---	---	---	---	505980	---	---	505980	---	(61)
516285	516285	516285	516285	516285	516285	516285	516285	516285	516285	(62)
112201	112201	112201	112201	112201	112201	112201	112201	112201	112201	(63)
137498	137498	137498	137498	137498	137498	137498	137498	137498	137498	(64)
---	---	177014	---	---	---	---	---	---	---	(65)
---	---	572261	---	---	---	---	---	---	---	(66)
---	---	166103	---	---	---	---	---	---	---	(67)
---	---	188412	---	---	---	---	---	---	---	(68)
---	---	188329	---	---	---	---	---	---	---	(69)
---	---	516972	---	---	---	---	---	---	---	(70)
---	---	516973	---	---	---	---	---	---	---	(71)
199005	199005	---	862217	199003	862217	---	---	862217	199005	(72)
862217	862217	---	517239	---	517239	---	---	517239	---	(73)
---	---	---	397092	---	397092	---	---	397106	---	(74)
---	---	---	517066	---	517066	---	---	517066	---	(75)
---	---	---	---	---	---	---	---	---	---	(76)
---	---	---	---	---	---	---	---	---	---	(77)
---	---	---	---	---	---	---	---	---	---	(78)
---	---	---	---	---	---	---	---	---	---	(79)
---	---	---	---	---	---	---	---	---	---	(80)
---	---	---	---	---	---	---	---	---	---	(81)
---	---	---	---	---	---	---	---	---	---	(82)
---	---	---	---	---	---	---	---	---	---	(83)
---	---	---	---	---	---	---	---	---	---	(84)
54520246	54520246	---	54520300	54520354	517238	54520510	54520510	54520575	517519	(85)
54520342	54520342	---	---	---	---	---	---	---	---	(86)
312	312	312	373	166	312	312	312	312	312	(87)
988	988	988	988	---	988	988	988	988	988	(88)



HEADLAMPS WITH AMMETERS AND SWITCHES

DETAILED SPARE PARTS

Part No.	58471A	58472A	58477A	58483A	58514A	58515A	58516A
Model	MCH56	MCH56	MCH61	MCH56	MCH61	MCH61EF	MCH61
(1) § Ammeter	36084	36084	36084	36084	36084	36084	36084
(2) § Ring, rubber, seating	523986	523986	523986	523986	523986	523986	523986
(3) § Nut, terminal	166043	166043	166043	166043	166043	166043	166043
(4) § Washer, terminal	185040	185040	185040	185040	185040	185040	185040
(5) § Switch, lighting	31784	31784	54033028	31718	54033109	54033109	54033028
(6) § Knob, with screw	351815	351815	†54330934	351815	†54330934	†54330934	†54330934
(7) § Screw, knob fixing	127301	127301	101371	127301	101371	101371	101371
(8) § Washer, knob fixing screw	185038	185038	332529	185038	332529	332529	332529
(9) § Key	—	—	—	—	—	—	—
(10) § Screw, terminal	120560	120560	—	120560	—	—	—
(11) § Nut, fixing	173777	173777	—	173777	—	—	—
(12) § Washer	188303	188303	—	188303	—	—	—
(13) § Shaft, headpiece	54330517	54330517	—	351789	—	—	—
(14) § Roller, contact	351660	351660	—	351660	—	—	—
(15) § Plunger, contact	351661	351661	—	351661	—	—	—
(16) § Spring, contact plunger	351662	351662	—	351662	—	—	—
(17) § Grommet	—	—	—	—	—	—	—
(18) § Rotor, lighting	—	—	—	—	—	—	—
(19) § Base, lighting	—	—	—	—	—	—	—
(20) § Terminal, lighting	—	—	—	—	—	—	—
(21) § Rotor, ignition	—	—	—	—	—	—	—
(22) § Terminal, ignition	—	—	—	—	—	—	—
(23) § Cap and plate	—	—	—	—	—	—	—
(24) § Screw, body fixing	—	—	—	—	—	—	—
(25) § Nut, spindle	—	—	—	—	—	—	—
(26) § Lever, contact	351528	351528	—	—	—	—	—
(27) § Connector, snap	—	—	900269	—	900269	900269	900269
(28) § Connector, tube, single	—	—	900288	—	900288	900288	900288
(29) § Connector, tube, double	—	—	850641	—	—	—	850641
(30) § Cover, rubber	—	—	332521	—	332521	332521	332521
(31) § Switch, ignition	—	—	—	—	54033027	54033027	54033056
(32) § Connector, snap	—	—	—	—	900269	900269	900269
(33) § Connector, tube, single	—	—	—	—	900288	900288	900288
(34) § Connector, tube, double	—	—	—	—	850641	850641	—
(35) § Cover, rubber	—	—	—	—	332521	332521	332521
(36) § Knob, with screw	—	—	—	—	54332498	54332498	54332498
(37) § Screw, knob fixing	—	—	—	—	101371	101371	101371
(38) § Washer, dished, fixing screw	—	—	—	—	332529	332529	332529
(39) § Plate, escutcheon	351803	351803	—	351803	—	—	—
(40) § Disc, insulating	—	—	—	—	—	—	—
(41) § Rim or door	534343	534343	553248	534343	553248	553248	553248
(42) § Wire, fixing	504665	504665	504665	504665	504665	504665	504665
(43) § Screw, rim fixing	144921	144921	144921	144921	144921	144921	144921
(44) § Plate, rim fixing screw	534296	534296	534296	534296	534296	534296	534296
(45) § Light unit	516828	516828	516798	516828	555275	516802	555275
(46) § Backshell	—	—	—	—	—	552943	—
(47) § Bulb holder, main	554602	554602	554602	554602	554602	562303	554602
(48) § Clip and screw	—	—	—	—	—	562306	—
(49) § Sleeve, terminal	555910	555910	555910	555910	555910	555910	555910
(50) § Bulb holder, pilot	554710	554710	554710	554710	554710	554710	554710
(51) § Interior, bulb holder	553780	553780	553780	553780	553780	553780	553780
(52) § Ring, bulb holder seating	554354	554354	554354	554354	554354	554354	554354
(53) § Bush, rubber, cable entry	—	—	—	—	—	—	—
(54) § Washer, cable grip	516285	516285	516285	516285	516285	516285	516285
(55) § Screw, lamp fixing	112201	112201	112201	112201	112201	112201	112201
(56) § Washer, lamp fixing screw	137498	137498	137498	137498	137498	137498	137498
(57) § Medallion	—	—	—	—	—	—	—
(58) § Gasket, medallion	—	—	—	—	—	—	—
(59) § Connector, single	—	—	—	—	—	—	—
(60) § Plug and cable	—	—	—	—	—	—	—
(61) § Screw, plug fixing	—	—	—	—	—	—	—
(62) § Nut, plug fixing screw	—	—	—	—	—	—	—
(63) § Washer, plug fixing screw	—	—	—	—	—	—	—
(64) § Grommet, cable entry	199005	199005	—	199005	—	—	—
(65) § Grommet, trip cable	—	—	—	—	—	—	—
(66) § Grommet, body	862217	862217	—	862217	—	—	—
(67) § Ring, plug retaining	—	—	—	—	—	—	—
(68) § Body	54520609	54520610	54520728	517519	54520510	54520510	54520510
(69) § Bulb, main	312	312	312	312	403	—	403
(70) § Bulb, pilot	988	988	988	988	988	988	988

† Order separately § Recommended spares for stock

HEADLAMPS WITH AMMETERS AND SWITCHES



DETAILED SPARE PARTS

58471 — 58599

58517A MCH6IEF	58518A MCH6I	58519A MCH6IEF	58556A SS700P	58583A MCH6I	58584A MCH6I	58586A SS700P	58597A MCH6I	58598A MCH6I	58599A MCH6IEF	
36084	36084	36084	36084	36084	36084	36084	36084	36084	36084	(1)
523986	523986	523986	523986	523986	523986	523986	523986	523986	523986	(2)
166043	166043	166043	166043	166043	166043	166043	166043	166043	166043	(3)
185040	185040	185040	185040	185040	185040	185040	185040	185040	185040	(4)
54033028	54033028	54033028	—	31443	31443	31620	31443	31443	31443	(5)
†54330934	†54330934	†54330934	—	†318346	†318346	—	†318346	†318346	†318346	(6)
101371	101371	101371	—	319333	319333	—	319333	319333	319333	(7)
332529	332529	332529	—	—	—	—	—	—	—	(8)
—	—	—	—	318341	318341	—	318341	318341	318341	(9)
—	—	—	—	120584	120584	120560	120584	120584	120584	(10)
—	—	—	—	180670	180670	314540	180670	180670	180670	(11)
—	—	—	—	—	—	—	—	—	—	(12)
—	—	—	—	—	—	—	—	—	—	(13)
—	—	—	—	—	—	—	—	—	—	(14)
—	—	—	—	—	—	—	—	—	—	(15)
—	—	—	—	—	—	—	—	—	—	(16)
—	—	—	—	318323	318323	—	318323	318323	318323	(17)
—	—	—	—	313053	313053	—	313053	313053	313053	(18)
—	—	—	—	318314	318314	—	318314	318314	318314	(19)
—	—	—	—	318349	318349	—	318349	318349	318349	(20)
—	—	—	—	313052	313052	—	313052	313052	313052	(21)
—	—	—	—	318316	318316	—	318316	318316	318316	(22)
—	—	—	—	318331	318331	—	318331	318331	318331	(23)
—	—	—	—	198887	198887	—	198887	198887	198887	(24)
—	—	—	—	169294	169294	—	169294	169294	169294	(25)
—	—	—	—	—	—	—	—	—	—	(26)
900269	900269	900269	—	—	—	—	—	—	—	(27)
900288	900288	900288	—	—	—	—	—	—	—	(28)
850641	850641	850641	—	—	—	—	—	—	—	(29)
332521	332521	332521	—	—	—	—	—	—	—	(30)
54033056	—	—	—	—	—	—	—	—	—	(31)
900269	—	—	—	—	—	—	—	—	—	(32)
900288	—	—	—	—	—	—	—	—	—	(33)
—	—	—	—	—	—	—	—	—	—	(34)
—	—	—	—	—	—	—	—	—	—	(35)
332521	—	—	—	—	—	—	—	—	—	(36)
54332498	—	—	—	—	—	—	—	—	—	(37)
101371	—	—	—	—	—	—	—	—	—	(38)
332529	—	—	—	—	—	—	—	—	—	(39)
—	—	—	—	318942	318942	—	318942	318942	318942	(40)
—	—	—	—	318344	318344	—	318344	318344	318344	(41)
553248	553248	553248	553248	553248	553248	553248	553248	553248	553248	(42)
504665	504665	504665	504665	504665	504665	504665	504665	504665	504665	(43)
144921	144921	144921	144921	144921	144921	144921	144921	144921	144921	(44)
534296	534296	534296	534296	534296	534296	534296	534296	534296	534296	(45)
516802	555275	516802	516798	555309	555309	516798	516798	555275	516802	(46)
552943	—	552943	—	—	—	—	—	—	552943	(47)
562303	554602	562303	554602	554602	554602	554602	554602	554602	562303	(48)
562306	—	562306	—	—	—	—	—	—	562306	(49)
555910	555910	555910	555910	555910	555910	555910	555910	555910	555910	(50)
554710	554710	554710	554710	554710	554710	554710	554710	554710	554710	(51)
553780	553780	553780	553780	553780	553780	553780	553780	553780	553780	(52)
554354	554354	554354	554354	554354	554354	554354	554354	554354	554354	(53)
—	—	—	—	505980	505980	—	505980	505980	505980	(54)
516285	516285	516285	516285	516285	516285	516285	516285	516285	516285	(55)
112201	112201	112201	112201	112201	112201	112201	112201	112201	112201	(56)
137498	137498	137498	137498	137498	137498	137498	137498	137498	137498	(57)
—	—	—	—	397092	397092	—	397092	397092	397092	(58)
—	—	—	—	517066	517066	—	517066	517066	517066	(59)
—	—	—	—	—	—	900288	—	—	—	(60)
—	—	—	54944387	—	—	54946012	—	—	—	(61)
—	—	—	133303	—	—	133303	—	—	—	(62)
—	—	—	166103	—	—	166103	—	—	—	(63)
—	—	—	188412	—	—	188412	—	—	—	(64)
—	—	—	199002	862217	862217	—	862217	862217	862217	(65)
—	—	—	—	517239	517239	—	517239	517239	517239	(66)
—	—	—	—	—	—	—	—	—	—	(67)
—	—	—	516409	—	—	516409	—	—	—	(68)
54520510	54520728	54520728	54520774	54520300	54520844	54520852	54520300	54520300	54520300	(69)
—	403	—	312	373	373	312	312	403	—	(70)
988	988	988	988	988	988	988	988	988	988	(70)

† Order separately

continued



HEADLAMPS WITH AMMETERS AND SWITCHES

DETAILED SPARE PARTS

Part No.	58670A MCH56 EF	58672A MCH56 EF	58673A MCH56 EF	58702A MCH61	58704A MCH61	58761A MCH61	58830A MCH61	58831A MCH61 EF
(1) Instrument panel	—	—	—	—	—	—	—	—
(2) Screw, panel fixing	—	—	—	—	—	—	—	—
(3) Ammeter	36084	36084	36084	36084	36084	36084	36084	36084
(4) Ring, rubber, seating	523986	523986	523986	523986	523986	523986	523986	523986
(5) Nut, terminal	166043	166043	166043	166043	166043	166043	166043	166043
(6) Washer, terminal	185040	185040	185040	185040	185040	185040	185040	185040
(7) Switch, lighting	54033004	54033004	54033028	34289	34289	31784	34289	34289
(8) Knob, with screw	†54330662	†54330662	†54330662	†54330934	†54330934	351815	†54330934	†54330934
(9) Screw, knob fixing	101371	101371	101371	101371	101371	127301	101371	101371
(10) Washer, knob fixing screw	332529	332529	332529	332529	332529	185038	332529	332529
(11) Screw, terminal	—	—	—	—	—	120560	—	—
(12) Nut, fixing	180316	180316	180316	180316	180316	173777	180316	180316
(13) Washer	185128	185128	185128	185128	185128	188303	185128	185128
(14) Shaft, headpiece	—	—	—	—	—	54330517	—	—
(15) Roller, contact	—	—	—	—	—	351660	—	—
(16) Plunger, contact	—	—	—	—	—	351661	—	—
(17) Spring, contact plunger	—	—	—	—	—	351662	—	—
(18) Lever, contact	—	—	—	—	—	351528	—	—
(19) Socket, with cables	—	—	—	†54930007	—	—	†54930007	†54930007
(20) Connector, snap	900269	900269	900269	—	—	—	—	—
(21) Connector, tube, single	900288	900288	900288	—	—	—	—	—
(22) Connector, tube, double	—	—	850641	—	—	—	—	—
(23) Cover, rubber	332521	332521	332521	—	—	—	—	—
(24) Switch, ignition	54033003	54033003	54033027	34287	—	—	—	—
(25) Key	—	—	—	—	—	—	—	—
(26) Connector, snap	900269	900269	900269	—	—	—	—	—
(27) Connector, tube, single	900288	900288	900288	—	—	—	—	—
(28) Connector, tube, double	—	—	850641	—	—	—	—	—
(29) Cover, rubber	332521	332521	332521	—	—	—	—	—
(30) Nut, locking, switch fixing	180316	180316	180316	180316	—	—	—	—
(31) Washer, locking nut	185128	185128	185128	185128	—	—	—	—
(32) Socket, with cables	—	—	—	†54930008	—	—	—	—
(33) Knob, with screw	54330663	54330663	54330663	54332498	—	—	—	—
(34) Screw, fixing knob	101371	101371	101371	101371	—	—	—	—
(35) Washer, dished, fixing screw	332529	332529	332529	332529	—	—	—	—
(36) Plate, escutcheon	—	—	—	—	—	351803	—	—
(37) Switch, dip	—	—	—	—	—	—	—	—
(38) Nut, fixing	—	—	—	—	—	—	—	—
(39) Screw, terminal	—	—	—	—	—	—	—	—
(40) Rim or door	534343	534343	534343	553248	553248	553248	553248	553248
(41) Wire, fixing	504665	504665	504665	504665	504665	504665	504665	504665
(42) Screw, rim fixing	144921	144921	144921	144921	144921	144921	144921	144921
(43) Plate, rim fixing screw	534296	534296	534296	534296	534296	534296	534296	534296
(44) Light unit	54520858	54521021	516912	516798	516798	516798	555275	516802
(45) Backshell	—	—	552943	—	—	—	—	552943
(46) Bulb holder	554602	554602	562303	554602	554602	554602	554602	562303
(47) Clip and screw	—	—	562306	—	—	—	—	562306
(48) Sleeve, terminal	555910	555910	555910	555910	555910	555910	555910	555910
(49) Bulb holder, pilot	554710	554710	554710	554710	554710	554710	554710	554710
(50) Interior, bulb holder	553780	553780	553780	553780	553780	553780	553780	553780
(51) Ring, seating, bulb holder	554354	554354	554354	554354	554354	554354	554354	554354
(52) Bush, rubber, cable entry	—	—	—	—	—	505980	—	—
(53) Washer, cable grip	516285	516285	516285	516285	516285	516285	516285	516285
(54) Screw, lamp fixing	112201	112201	112201	112201	112201	112201	112201	112201
(55) Washer, lamp fixing screw	137498	137498	137498	137498	137498	137498	137498	137498
(56) Screw, cable grip	—	—	—	—	—	—	—	—
(57) Grommet, cable entry	199005	199005	199005	—	—	862217	—	—
(58) Grommet, trip cable	—	—	—	—	—	517239	—	—
(59) Medallion	—	—	—	—	—	397092	—	—
(60) Gasket, medallion	—	—	—	—	—	517066	—	—
(61) Connector, single	—	—	—	—	—	—	—	—
(62) Plug and cable	—	—	—	—	—	—	—	—
(63) Screw, plug fixing	—	—	—	—	—	—	—	—
(64) Nut, screw plug fixing	—	—	—	—	—	—	—	—
(65) Washer, plug fixing screw	—	—	—	—	—	—	—	—
(66) Ring, plug retaining	—	—	—	—	—	—	—	—
(67) Body	54520871	54520871	54520871	54520510	54520728	54521353	54520728	54520728
(68) Bulb, main	312	377	—	312	312	312	403	—
(69) Bulb, pilot	988	988	988	988	988	988	988	988

† Order separately § Recommended spares for stock

HEADLAMPS WITH AMMETERS AND SWITCHES



DETAILED SPARE PARTS

58670 — 58937

58832A MCH61	58833A MCH61 EF	58859A SSU700P	58878A SS700P	58885A MCH61	58892B MCH56	58893B MCH56	58896B MCH56 EF	58934A SS700P	58935A MCH66	58937A SS700P	
—	—	54521611	—	—	—	—	—	—	—	—	(1)
—	—	186130	—	—	—	—	—	—	—	—	(2)
36084	36084	36296	36296	36084	36084	36084	36084	36296	—	36296	(3)
523986	523986	—	—	523986	523986	523986	523986	—	—	—	(4)
166043	166043	166043	166043	166043	166043	166043	166043	166043	—	166043	(5)
185040	185040	185040	185040	185040	185040	185040	185040	185040	—	185040	(6)
34289	34289	31763	—	31784	34289	34289	34289	—	—	—	(7)
†54330934	†54330934	351815	—	351815	†54330934	†54330934	†54330934	—	—	—	(8)
101371	101371	127301	—	127301	101371	101371	101371	—	—	—	(9)
332529	332529	185038	—	185038	332529	332529	332529	—	—	—	(10)
—	—	120560	—	120560	—	—	—	—	—	—	(11)
180316	180316	173777	—	173777	180316	180316	180316	—	—	—	(12)
185128	185128	188303	—	188303	185128	185128	185128	—	—	—	(13)
—	—	351789	—	54330517	—	—	—	—	—	—	(14)
—	—	351660	—	351660	—	—	—	—	—	—	(15)
—	—	351661	—	351661	—	—	—	—	—	—	(16)
—	—	351662	—	351662	—	—	—	—	—	—	(17)
—	—	—	—	—	—	—	—	—	—	—	(18)
†54930007	†54930007	—	—	—	†54930007	†54930007	†54930007	—	—	—	(19)
—	—	—	—	—	—	—	—	—	—	—	(20)
—	—	—	—	—	—	—	—	—	—	—	(21)
—	—	—	—	—	—	—	—	—	—	—	(22)
—	—	—	—	—	—	—	—	—	—	—	(23)
34287	34287	—	—	—	34427	34427	34427	—	—	—	(24)
—	—	—	—	—	54336176	54336176	54336176	—	—	—	(25)
—	—	—	—	—	—	—	—	—	—	—	(26)
—	—	—	—	—	—	—	—	—	—	—	(27)
—	—	—	—	—	—	—	—	—	—	—	(28)
—	—	—	—	—	54336178	54336178	54336178	—	—	—	(29)
180316	180316	—	—	—	54336177	54336177	54336177	—	—	—	(30)
185128	185128	—	—	—	—	—	—	—	—	—	(31)
†54930008	†54930008	—	—	—	—	—	—	—	—	—	(32)
54332498	54332498	—	—	—	—	—	—	—	—	—	(33)
101371	101371	—	—	—	—	—	—	—	—	—	(34)
332529	332529	—	—	—	—	—	—	—	—	—	(35)
—	—	351803	—	351803	—	—	—	—	—	—	(36)
—	—	—	—	—	—	—	—	—	—	—	(37)
—	—	—	—	—	—	—	—	—	31620	—	(38)
—	—	—	—	—	—	—	—	—	314540	—	(39)
—	—	—	—	—	—	—	—	—	120560	—	(40)
553248	553248	553248	553248	553248	534343	534343	534343	553248	534343	553248	(41)
504665	504665	504665	504665	504665	504665	504665	504665	504665	504665	504665	(42)
144921	144921	144921	144921	144921	144921	144921	144921	144921	144921	144921	(43)
534296	534296	534296	534296	534296	534296	534296	534296	534296	534296	534296	(44)
555275	516802	516798	516798	516798	54520858	54521021	516912	516798	516828	516798	(45)
—	552943	—	—	—	—	—	—	552943	—	—	(46)
554602	562303	554602	554602	554602	554602	554602	562303	554602	554602	554602	(47)
—	562306	—	—	—	—	—	562306	—	—	—	(48)
555910	555910	555910	555910	555910	555910	555910	555910	555910	555910	555910	(49)
554710	554710	554710	554710	554710	554710	554710	554710	554710	554710	554710	(50)
553780	553780	553780	553780	553780	553780	553780	553780	553780	553780	553780	(51)
554354	554354	554354	554354	554354	554354	554354	554354	554354	554354	554354	(52)
—	—	—	—	505980	—	—	—	—	—	—	(53)
516285	516285	516285	516285	516285	516285	516285	516285	516285	—	516285	(54)
112201	112201	112201	112201	112201	112201	112201	112201	112201	112201	112201	(55)
137498	137498	137498	137498	137498	137498	137498	137498	137498	137498	137498	(56)
—	—	186157	—	—	—	—	—	—	—	—	(57)
—	—	—	199002	862217	199005	199005	199005	—	—	199002	(58)
—	—	—	—	517329	—	—	—	—	—	—	(59)
—	—	—	—	397092	—	—	—	—	—	—	(60)
—	—	—	—	517066	—	—	—	—	—	—	(61)
—	—	900288	—	—	—	—	—	—	—	—	(62)
—	—	54941768	54944387	—	—	—	—	—	—	54944387	(63)
—	—	133303	133303	—	—	—	—	—	—	133303	(64)
—	—	166103	166103	—	—	—	—	—	—	166103	(65)
—	—	188412	188412	—	—	—	—	—	—	188412	(66)
—	—	516409	516409	—	—	—	—	—	—	516409	(67)
54520510	54520510	54520009	54520774	54520392	54520397	54520397	54520397	54521793	54521888	54521860	(68)
403	—	312	312	312	312	377	—	312	166	312	(69)
988	988	988	988	988	988	988	988	988	988	988	(69)

† Order separately



HEADLAMPS LESS AMMETERS AND SWITCHES

DETAILED SPARE PARTS

Part No.	50943E	51112D	51134D	51519B/D	51547D/E	51548D
Model	MCF700	MCF700	MCF700EF	MCF575P	MCF575P	MCF575
Replaced by	—	—	—	—	—	—
(1) §Ammeter	—	—	—	—	—	—
(2) § Nut, terminal	—	—	—	—	—	—
(3) § Washer, terminal	—	—	—	—	—	—
(4) §Switch, dip	—	—	—	—	—	—
(5) § Nut, fixing	—	—	—	—	—	—
(6) § Screw, terminal	—	—	—	—	—	—
(7) §Rim or door	553248	553248	553248	516723	516723	516723
(8) Plate, rim fixing	554408	554408	544408	516709	516709	516709
(9) §Screw, rim fixing	144921	144921	144921	516710	516710	516710
(10) Ring or washer, screw retaining	—	—	—	—	—	—
(11) Nut, rim screw	—	—	—	166014	166014	166014
(12) Spring, rim fixing	—	—	—	552373	552373	552373
(13) §Wires, fixing	504665	504665	504665	500291	500291	500291
(14) §Light unit	553925	553940	553948	516728	516658	516659
(15) §Backshell	—	—	552943	—	—	—
(16) § Bulb holder	554602	554602	562303	554946	†516651	†516651
Clip and screw	—	—	562306	—	—	—
(18) § Sleeve, terminal	555910	555910	555910	555910	555910	555910
(19) § Interior, speedometer illumination	—	—	—	—	555906	555906
(20) §Bulb holder, pilot	—	—	—	554710	554710	—
(21) § Interior, pilot	—	—	—	553780	553780	—
(22) § Ring, bulb holder seating	—	—	—	554354	554354	—
(23) Ring, fixing	553267	553267	553267	—	—	—
(24) Washer, cable grip	—	—	—	516285	516285	516285
(25) §Screw, lamp fixing	—	—	—	—	—	—
(26) Washer, lamp fixing screw	—	—	—	—	—	—
(27) §Connector, single	—	—	—	—	—	—
(28) §Nipple, cable	—	—	—	—	—	—
(29) §Grommet, cable entry	—	—	—	—	—	—
(30) Plug, with cable	—	—	—	—	—	—
(31) §Screw, plug fixing	—	—	—	—	—	—
(32) Nut, plug fixing screw	—	—	—	—	—	—
(33) Washer, fixing screw	—	—	—	—	—	—
(34) Ring, plug retaining	—	—	—	—	—	—
(35) Body	—	—	—	—	—	—
(36) Bulb holder, speedometer illumination	—	—	—	—	516741	516741
(37) §Bulb, main	312	403	—	312	377	312
(38) §Bulb, pilot or speedometer illumination	—	—	—	988	988	988

§ Recommended spares for stock

† Serviced by 554946 and 516741

HEADLAMPS LESS AMMETERS AND SWITCHES



DETAILED SPARE PARTS

50943 — 51860

51634B MCF575PEF —	*51750B MCF575P (51519)	51756E MCF700P —	51757D MCF700P —	51758B MCF700P —	51820B SS700PEF —	51856A MCF700 —	51860B MCF700P —	
—	—	—	—	—	—	—	—	(1)
—	—	—	—	—	—	—	—	(2)
—	—	—	—	—	—	—	—	(3)
—	—	—	—	—	—	—	—	(4)
—	—	—	—	—	—	—	—	(5)
—	—	—	—	—	—	—	—	(6)
516910	516723	553248	553248	553248	553248	553248	553248	(7)
516709	516709	554408	554408	554408	534296	554408	554408	(8)
516710	516710	144921	144921	144921	144921	144921	144921	(9)
524215	—	—	—	—	—	—	—	(10)
166014	166014	—	—	—	—	—	—	(11)
552373	552373	—	—	—	—	—	—	(12)
516911	500291	504665	504665	504665	504665	504665	504665	(13)
516912	516767	516810	516811	516802	516802	553921	516812	(14)
562304	—	—	—	552943	552943	—	—	(15)
562303	554946	554602	554602	562303	562303	554602	554602	(16)
562306	—	—	—	562306	562306	—	—	(17)
555910	555910	555910	555910	555910	555910	555910	555910	(18)
555906	—	—	—	—	—	—	—	(19)
554710	554710	554710	554710	554710	554710	—	554710	(20)
553780	553780	553780	553780	553780	553780	—	553780	(21)
554354	554354	554354	554354	554354	554354	—	554354	(22)
—	—	553267	553267	553267	—	553267	553267	(23)
516285	516285	—	—	—	—	—	—	(24)
—	—	—	—	—	112201	—	—	(25)
—	—	—	—	—	137498	—	—	(26)
—	—	—	—	—	900288	—	—	(27)
—	—	—	—	—	900269	—	—	(28)
—	—	—	—	—	—	—	—	(29)
—	—	—	—	—	—	—	—	(30)
—	—	—	—	—	—	—	—	(31)
—	—	—	—	—	—	—	—	(32)
—	—	—	—	—	—	—	—	(33)
—	—	—	—	—	—	—	—	(34)
—	—	—	—	—	517003	—	—	(35)
—	—	—	—	—	—	—	—	(36)
—	312	312	403	—	—	373	373	(37)
988	988	988	988	988	988	—	988	(38)



HEADLAMPS LESS AMMETERS AND SWITCHES

DETAILED SPARE PARTS

Part No.	51929A	51930A	51931A	51932A	58158A/B	58159A/B	58160A/B	58161A/B
Model	MCH60	MCH60	MCH60	MCH60 EF	MCF700P	MCF700P	MCF700P	MCF700P EF
(1) §Rim or door	553248	553248	553248	553248	553248	553248	553248	553248
(2) Plate, rim fixing	534296	534296	534296	534296	554408	554408	554408	554408
(3) §Screw, rim fixing	144921	144921	144921	144921	144921	144921	144921	144921
(4) Ring or washer, retaining screw	—	—	—	—	—	—	—	—
(5) Nut, rim fixing screw	—	—	—	—	—	—	—	—
(6) Bracket, rim fixing	—	—	—	—	—	—	—	—
(7) Spring, rim fixing	—	—	—	—	—	—	—	—
(8) §Wires, fixing	504665	504665	504665	504665	504665	504665	504665	504665
(9) §Light unit	555309	516798	555275	516802	516812	516810	516811	516802
(10) §Backshell	—	—	—	552943	—	—	—	552943
(11) § Bulb holder	554602	554602	554602	562303	555319	555319	554602	562303
(12) § Clip and screw	—	—	—	562306	—	—	—	562306
(13) § Sleeve, terminal	555910	555910	555910	555910	555910	555910	555910	555910
(14) §Bulb holder, pilot	554710	554710	554710	554710	554710	554710	554710	554710
(15) § Interior, pilot bulb holder	553780	553780	553780	553780	553780	553780	553780	553780
(16) § Ring, bulb holder seating	554354	554354	554354	554354	554354	554354	554354	554354
(17) Ring, fixing	—	—	—	—	556402	556402	556402	556402
(18) Washer, cable grip	—	—	—	—	—	—	—	—
(19) §Screw, lamp fixing	112201	112201	112201	112201	—	—	—	—
(20) Washer, lamp fixing screw	137498	137498	137498	137498	—	—	—	—
(21) §Connector, single	—	—	—	—	—	—	—	—
(22) §Grommet, cable entry	859060	859060	859060	859060	—	—	—	—
(23) Excluder, dust	—	—	—	—	—	—	—	—
(24) §Plate, light unit retaining	—	—	—	—	—	—	—	—
(25) Screw, unit rim	—	—	—	—	—	—	—	—
(26) Rim, unit seating	—	—	—	—	—	—	—	—
(27) Body	517215	517215	517215	517215	—	—	—	—
(28) §Gasket, rubber	—	—	—	—	—	—	—	—
(29) Spring, trimmer	—	—	—	—	—	—	—	—
(30) Sleeve, sealing	—	—	—	—	—	—	—	—
(31) §Bulb, main	373	312	403	—	373	312	403	—
(32) §Bulb, pilot or speedometer illumina- tion	988	988	988	988	988	988	988	988

§ Recommended spares for stock

HEADLAMPS LESS AMMETERS AND SWITCHES



DETAILED SPARE PARTS

51929 — 58397

58204B MCF575 PH	58204D MCF575 PH	58204E MCF575 PH	58234B/D MCF575P	58258A/B F700P	58382A MCF575P	58383A MCH60	58391A MCF575P EF	58392A MCF575P	58396A MCF575 PH	58397A MCF575 PEF	
54520003	54520003	54520003	534343	554440	516723	553248	534343	534343	54520003	54520003	(1)
534296	534296	534296	534296	—	516709	534296	534296	534296	534296	534296	(2)
555911	555911	555911	144921	198898	516710	144921	144921	144921	555911	555911	(3)
—	—	—	—	161385	—	—	—	—	—	—	(4)
—	—	—	—	187117	166014	—	—	—	—	—	(5)
—	—	—	—	555704	—	—	—	—	—	—	(6)
—	—	—	—	—	552373	—	—	—	—	—	(7)
504665	504665	504665	504665	—	500291	504665	504665	504665	504665	504665	(8)
516828	516828	516828	516828	516798	516728	—	516912	516829	516829	516829	(9)
—	—	—	—	—	—	—	553470	—	—	553470	(10)
554602	554602	554602	554602	554602	554946	—	562303	554602	554602	562303	(11)
—	—	—	—	—	—	—	562306	—	—	562306	(12)
188818	188818	555910	555910	555910	555910	—	555910	555910	555910	555910	(13)
554710	554710	554710	554710	554710	554710	—	554710	554710	554710	554710	(14)
553780	553780	553780	553780	553780	553780	—	553780	553780	553780	553780	(15)
554354	554354	554354	554354	554354	554354	—	554354	554354	554354	554354	(16)
517527	517527	54520978	54520104	—	—	—	54520104	54520104	54520978	54520978	(17)
516285	516285	516285	516285	—	516285	—	516285	516285	516285	516285	(18)
—	—	—	—	—	—	—	—	—	—	—	(19)
—	—	—	—	—	—	—	—	—	—	—	(20)
—	—	—	900288	—	—	—	—	900288	900288	—	(21)
—	—	—	—	—	—	859060	—	—	—	—	(22)
—	—	—	—	552906	—	—	—	—	—	—	(23)
—	—	—	—	554872	—	—	—	—	—	—	(24)
—	—	—	—	186137	—	—	—	—	—	—	(25)
—	—	—	—	554871	—	—	—	—	—	—	(26)
—	—	—	—	—	—	—	—	—	—	—	(27)
—	—	—	—	555415	—	—	—	—	—	—	(28)
—	—	—	—	552813	—	—	—	—	—	—	(29)
—	—	—	—	554626	—	—	—	—	—	—	(30)
166	312	312	312	312	425	—	—	377	377	—	(31)
988	988	988	988	988	989	—	988	988	988	—	(32)



HEADLAMPS LESS AMMETERS AND SWITCHES

DETAILED SPARE PARTS

Part No.	58417A/D	58418A/D	58419A/D	58420A/D	58421A/D	58422A/D	58423A/D	58424A/B	58475A
Model	MCF575P	MCF575P	MCF575 PEF	MCF575	MCF575P	MCF575P	MCF575 PEF	MCF575	MCF575P
(1) §Rim or door	516723	516723	516910	516723	516723	516723	516910	516723	534343
(2) Plate, rim fixing	516709	516709	516709	516709	516709	516709	516709	516709	534296
(3) §Screw, rim fixing	516710	516710	516710	516710	516710	516710	516710	516710	144921
(4) Nut, rim screw	166014	166014	166014	166014	166014	166014	166014	166014	—
(5) Spring, rim fixing	552373	552373	552373	552373	552373	552373	552373	552373	—
(6) §Wires, fixing	500291	500291	516911	500291	500291	500291	516911	500291	504665
(7) §Light unit	516767	516658	516912	516659	516767	516658	516912	516659	516828
(8) §Backshell	—	—	553470	—	—	—	553470	—	—
(9) § Bulb holder	554946	554946	562303	554946	554946	554946	562303	554946	554602
(10) Clip and screw	—	—	562306	—	—	—	562306	—	—
(11) § Sleeve, terminal	555910	555910	555910	555910	555910	555910	555910	555910	555910
(12) §Bulb holder, pilot	554710	554710	554710	—	554710	554710	554710	—	554710
(13) § Interior, pilot	553780	553780	553780	—	553780	553780	553780	—	553780
(14) § Ring, bulb holder, seat- ing	554354	554354	554354	—	554354	554354	554354	—	554354
(15) Ring, fixing	—	—	—	—	—	—	—	—	—
(16) Washer, cable grip	516285	516285	516285	—	516285	516285	516285	—	516285
(17) §Screw, lamp fixing	—	—	—	—	—	—	—	—	—
(18) Washer, lamp fixingscrew	—	—	—	—	—	—	—	—	—
(19) §Connector, single	—	—	—	—	—	—	—	—	900288
(20) §Nipple, cable	—	—	—	—	—	—	—	—	—
(21) §Grommet, cable entry	—	—	—	—	—	—	—	—	—
(22) Plug, with cable	—	—	—	—	—	—	—	—	—
(23) §Screw, plug fixing	—	—	—	—	—	—	—	—	—
(24) Nut, plug fixing screw	—	—	—	—	—	—	—	—	—
(25) Washer, fixing screw	—	—	—	—	—	—	—	—	—
(26) Ring, plug retaining	—	—	—	—	—	—	—	—	—
(27) Body	—	—	—	—	—	—	—	—	—
(28) §Bulb, main	312	377	—	312	425	350	—	425	425
(29) §Bulb, pilot or speedometer illumination	988	988	988	—	989	989	989	—	989

§ Recommended spares for stock

HEADLAMPS LESS AMMETERS AND SWITCHES



DETAILED SPARE PARTS

58417 — 54052019

58552A MCF575P	58627A/D MCF575P	58829A SS700P	58897A MCF575 PH	58898A MCF575 PH	58899A MCF575 PEF	58900A SS700P	Part No.	54052019 Model
534343	534343	553248	54520003	54520003	54520003	553248 (1)	§Rim and reflector	517408
534296	534296	534296	534296	534296	534296	534296 (2)	§ Reflector	517296
144921	144921	144921	555911	555911	555911	144921 (3)	§ Gasket, glass seating	656118
—	—	—	—	—	—	— (4)	§ Glass	656105
—	—	—	—	—	—	— (5)	§ Rim or door assembly	54520204
504665	504665	504665	504665	504665	504665	504665 (6)	§ Rim or door	517332
516828	516828	516798	516828	516829	516912	516798 (7)	Wire, reflector fixing	524911
—	—	—	—	—	553470	— (8)	Clip, rim fixing	517333
554602	554602	554602	554602	554602	562303	554602 (9)	§Cushion, rubber, bulb holder	517304
—	—	—	—	—	562306	— (10)	§Bulb holder	517388
555910	555910	555910	555910	555910	555910	555910 (11)	§Switch, lighting	54033018
554710	554710	554710	554710	554710	554710	554710 (12)	Nut, fixing	180316
553780	553780	553780	553780	553780	553780	553780 (13)	Washer, fixing nut	185128
554354	554354	554354	554354	554354	554354	554354 (14)	Spindle and action plate	54331427
—	54520104	—	54521737	54521737	54521737	— (15)	Ring, retaining	154390
516285	516285	516285	516285	516285	516285	516285 (16)	Spring	332496
—	—	112201	—	—	—	112201 (17)	Contact, rotor	332489
—	—	137498	—	—	—	137498 (18)	§ Connector, tube, single	900288
—	900288	900288	—	900288	—	— (19)	§ Connector, snap	900269
—	—	900269	—	—	—	— (20)	§Knob, with screw	54331313
—	—	199002	—	—	—	199002 (21)	Washer, cable grip	517385
—	—	54944387	—	—	—	54944387 (22)	§Sleeve, terminal	188152
—	—	133303	—	—	—	133303 (23)	§Bolt, with nut and washer	54520317
—	—	166103	—	—	—	166103 (24)	Nut, lamp fixing	170510
—	—	188412	—	—	—	188412 (25)	Washer, shakeproof	188471
—	—	516409	—	—	—	516409 (26)	Bolt, lamp fixing	122530
—	—	54521617	—	—	—	— (27)	Body	517382
312	425	312	312	377	—	312 (28)	§Bulb, main	386
988	222	988	988	988	988	988 (29)	§Bulb, pilot or speedometer illumination	974



TAIL, STOP TAIL AND NUMBER PLATE LAMPS

DETAILED SPARE PARTS

Part No.	53256A 529 Tail and number plate	53256B 529 Tail and number plate	53324A 544 Tail and number plate	53331A/B 529 Stop tail and number plate	53394B 564 Stop tail, number plate and reflex	53428B 529 Tail and number plate	53429A/B 529 Stop tail and number plate
§ Lens	526404	526404	526463	526404	573839	526404	526404
§ Window	526406	526406	526466	526406	575200	526406	526406
§ Gasket, lens seating	—	—	—	—	575208	—	—
§ Screw or nut, lens fixing	133551	133551	133231	133551	575219	133551	133551
§ Washer, retaining screw	161020	161020	—	161020	—	161020	161020
Base, with bulb holder and bracket	—	—	—	526421	—	—	526421
Backplate	—	—	526468	—	—	—	—
§ Bulb holder	554719	575990	526469	526418	—	575990	526418
§ Interior, bulb holder	553780	553780	—	573828	573828	553780	573828
Washer, interior, bulb holder	—	—	125533	—	—	—	—
Earth strip	—	—	526471	—	—	—	—
Base	526408	526408	—	526415	576002	526408	526415
§ Grommet, bulb holder	—	—	—	—	575207	—	—
§ Shell, bulb holder	—	—	—	—	575209	—	—
§ Grommet, cable entry	—	—	—	—	573825	—	—
Screw, base or lamp fixing	526410	526410	100394	526410	—	526410	526410
Nut, base or lamp fixing screw	166103	166103	166094	166103	166014	166103	166103
Washer, base fixing screw	188412	188412	188412	188412	—	188412	188412
Washer, shakeproof	—	—	—	—	188327	—	—
Washer, spacer fixing bolt	—	—	—	—	131023	—	—
Bulb	988	988	990	352	352	951	384

Part No.	53432B 564 Stop tail, number plate and reflex	53454B 564 Stop tail, number plate and reflex	53555A/B 590 Tail and number plate	53555D 590 Tail and number plate	53555E 590 Tail and number plate	53825A 564 Tail and number plate	53972A 679 Stop tail, number plate and reflex
§ Lens	573839	573839	526563	54570783	54570783	573839	54572932
§ Window	575200	575200	—	—	—	575200	—
§ Gasket, lens seating	575208	575208	526565	526565	526565	575208	—
§ Screw or nut, lens fixing	575219	575219	526567	526567	526567	575219	572289
§ Bulb holder	—	—	526569	526569	54570884	—	54572950
§ Interior, bulb holder	573828	573828	—	—	—	573832	573828
Washer, interior, bulb holder	—	—	125533	125533	54570388	—	—
Earth strip	—	—	526573	—	—	—	—
Base	576002	575964	526568	526568	526568	54571053	54571319
Plate, bulb holder	—	—	—	—	54571232	—	—
Wire, earth	—	—	—	—	526424	—	—
§ Grommet, bulb holder	575207	575207	—	—	—	575207	—
§ Shell, bulb holder	575209	575209	—	—	—	54571021	—
§ Grommet, cable entry	573825	573825	—	—	—	573825	—
§ Gasket, lamp seating	—	—	—	—	—	—	54571677
Screw, base or lamp fixing	—	—	—	—	—	—	127684
Nut, base or lamp fixing screw	166014	166014	166014	166014	166014	166014	—
Washer, base fixing screw	—	—	—	—	—	—	188483
Washer, shakeproof	188327	188327	188327	188327	188327	188327	—
Washer, spacer fixing bolt	131023	131023	—	—	—	131023	—
Bulb	384	380	990	990	990	205	384

§ Recommended spares for stock



**SIDE, SIDECAR, FLASHER OR PILOT LAMPS
DETAILED SPARE PARTS**

Part No. Model	52233B 516	52234A 550	52268D 569	52268E 569	53733A/D 628	53977A 628
§Cover	—	—	526514	526514	—	—
§Screw, cover fixing	—	—	145231	145231	—	—
§Screw, bulb holder fixing	116141	—	—	—	—	—
Washer, retaining screw	161385	—	—	—	—	—
§Rim, front	573646	526496	—	—	—	—
§Gasket, lens seating	573619	—	—	—	535904	535904
§Lens	573615	573615	526522	526522	535901	535901
§Lens (red)	—	—	526521	54570739	—	—
§Nut, lens fixing	—	—	—	—	526567	526567
Bracket or base, with adaptor	574500	—	526518	526518	54570349	54570349
§Interior, bulb holder	553780	553780	553780	553780	—	—
Bulb holder, shell	—	554539	—	—	—	—
§Sleeve, terminal or earth	—	526494	—	—	555910	555910
§Bulb	988	988	951	951	317	382
§Nut, lamp fixing	181261	—	181261	181261	—	—
Washer, lamp fixing	185085	—	188350	188350	—	—
Base, lamp mounting	573618	—	—	—	—	—
Washer, seating	551803	—	146240	146240	—	—
Bolt, lamp fixing	520395	—	520325	520325	—	—
Plate, locking, fixing bolt	—	—	526519	526519	—	—
§Grommet, cable entry	—	—	526520	526520	199000	199000
§Body	—	526493	526513	526513	—	—

**WARNING LIGHTS
DETAILED SPARE PARTS**

Part No. Model Replaced by	38049A WL3/1	38118A WL13	*38134A WL13 (38049)	38187A WL13	38188A WL13
§Cover and/or window	318896	319106	319257	319304	319303
§Set of fixing parts	318864	—	—	—	—
Shade	—	319222	—	305569	305569
§Bulb holder	—	554734	554734	554734	554734
Nut, terminal	180170	—	—	—	—
Screw, terminal	100521	—	100521	100521	100521
§Washer, spring, terminal screw	185012	—	185012	185012	185012
§Washer, spring, terminal	185040	—	—	—	—
Bracket, connector	—	—	319220	319214	319214
Body, bakelite	—	—	319204	—	—
Nut, body	—	—	319203	—	—
§Bulb	* 970	987	987	990	990

Part No. Model Replaced by	38192A WL15	38193A WL13	38194A WL13	*38197A/E WL13 (38118)	38198A/E WL13
§Cover and/or window	—	319303	319304	54332598	54332598
Shade	—	305569	305569	319222	319222
§Bulb holder	†54945043	554734	554734	554734	554734
§Bulb	†281	990	990	987	998

**WARNING LIGHTS
(Sundries)**

Part No.	Description	Part No.	Description
319106	Cover and window (red)	863511	Bulb holder (insulated return)
319107	Cover and window (green)	†54360213	Cover, window and shade (green)
319222	Shade	987	Bulb (12 volt, 2.2 watt)
†319335	Cover, window and shade (red)	990	Bulb (6 volt, 3 watt)
†319383	Cover, window and shade (green)		

* When ordering, quote part number shown in brackets

† Order separately

§ Recommended spares for stock



REFLEX REFLECTORS — BULBS

REFLEX REFLECTORS DETAILED SPARE PARTS

Part No. Model .. Replaced by ..	*57048B RER5 (57131)	57080A RER16	57098A RER22	57110A RER25	57116A RER25	57131A RER25
§ Rim, reflex	573801	575481	575908	54570241	54570241	54570241
Reflector, reflex	574749	574749	575883	575878	575878	575878
Holder, reflex	573871	575480	—	54570242	54570242	54571096
Nut, fixing	—	175300	—	166094	—	—
Washer, fixing	—	188330	—	188412	—	—
Screw, unit fixing	—	—	—	133724	198877	—
Washer, reflector seating	—	—	—	135120	135120	—

BULBS

HEADLAMP (PRE-FOCUS) — DOUBLE FILAMENT

Bulb No.	Illustration Reference	Volts	Watts	BPF Contact	Filament	Replaces Bulb No.
166	C	6	24/24	Double	Transverse, vertical dip	—
307	D	6	36/36	Double	Transverse, right hand dip	—
311	C	6	18/18	Double	Transverse, vertical dip	188
312	C	6	30/24	Double	Transverse, vertical dip	174
350	E	12	35/35	Double	Transverse duplo, vertical dip	—
373	D	6	30/24	Double	Transverse, left hand dip	—
377	E	6	25/25	Double	Duplo, hooded	—
378	E	6	45/40	Double	Transverse duplo, vertical dip	—
403	E	6	35/35	Double	Bow hooded, axial, duplo (Export Europe)	—
425	C	12	24/24	Double	Transverse, vertical dip	—
502	C	6	30/24	Double	Transverse, vertical dip	—

HEADLAMP — DOUBLE FILAMENT

Bulb No.	Illustration Reference	Volts	Watts	Contact	Cap	Filament	Replaces Bulb No.
168	F	6	24/24	Double	SBC	Transverse	101, 102, 115 and 116S.
169	F	6	30/30	Double	SBC	Transverse	61, 69 and 170.
180	F	6	18/18	Double	SBC	Transverse	65.
386	F	6	15/15	Double	SBC	Transverse	—
387	F	6	18/18	Double	SBC	Transverse	—

HEADLAMP (DUPLO — VERTICAL DIP — CLEAR GLASS)

Bulb No.	Illustration Reference	Volts	Watts	Cap	Filament and Balloon Dimension
388	X	6	15/15	Bosch	Duplo, 35.5 mm., hooded pear.
389	Y	6	15/15	SBC, index, offset pin	Duplo, 29 mm., hooded pear.
391	Y	6	15/15	SBC, one long and one short pin	Duplo, 29 mm., hooded pear.
392	X	6	25/25	Bosch	Duplo, 35.5 mm., hooded pear.
393	X	6	35/35	Bosch	Duplo, 35.5 mm., hooded pear.
394	X	12	25/25	Bosch	Duplo, 35.5 mm., hooded pear.
395	X	12	35/35	Bosch	Duplo, 35.5 mm., hooded pear.

FOGLAMP AND DRIVING LAMPS (PRE-FOCUS) — SINGLE FILAMENT

Bulb No.	Illustration Reference	Volts	Watts	BPF Contact	Filament	Replaces Bulb No.
163	B	6	24	Single	Transverse	—
172	A	6	36	Single	Axial	160, 161 and 164.
173	B	6	36	Single	Transverse	193 and 318.
†659	A	6	36	Single	Axial	—

* When ordering, quote part number shown in brackets

† Cadmium yellow

§ Recommended spares for stock

SBC .. Small bayonet cap

BULBS



SIDE, STOP TAIL AND NUMBER PLATE — PILOT, FLASHER AND WARNING LIGHTS

Bulb No.	Illustration Reference	Volts	Watts	Contact	Cap	Filament	Replaces Bulb No.
190	K	6	3/18	Double	SBC	Transverse	—
‡200	G	6	3	Single	SCC	Coil	113
204	G	6	3	Double	SBC	Coil	—
205	G	6	6	Single	SCC	Coil	105
206	G	6	6	Double	SBC	Coil	—
222	H	12	4	Single	MCC	Coil	—
281	—	12	2	Single	BA7S	Coil	—
282	—	6	6	Single	BA7S	Coil	—
317	—	6	18	Single	SCC	Transverse	—
319	—	6	18	Double	SBC	Transverse	—
‡352	J	6	3/18	Double	SBC	Transverse	—
380	J	12	6/21	Double	SBC, offset pin	Transverse	—
382	—	12	21	Single	SCC	Transverse	—
383	K	6	6/18	Double	SBC	Transverse	—
384	J	6	6/18	Double	SBC, offset pin	Transverse	—
640	H	6	1.8	Single	MCC	Coil, 11 mm. ..	—
641	H	6	3	Single	MCC	Coil	—
643	H	12	2.2	Single	MCC	Coil, 11 mm. ..	—
950	L	6	6	Single	MES	Coil	—
951	H	6	6	Single	MCC	Coil	—
955	L shielded balloon	6	2	Single	MES	Coil, 11 mm., shielded	—
956	L shielded balloon	12	3	Single	MES	Coil, 11 mm., shielded	—
970	L	2.5	2 amp.	Single	MES	Coil	—
974	L	3.5	15 amp.	Single	MES	Coil	—
977	L	3.5	3 amp.	Single	MES	Coil	—
987	L	12	2.2	Single	MES	Coil, 11 mm. ..	—
‡988	H	6	3	Single	MCC	Coil	—
989	H	12	6.	Single	MCC	Coil	—
‡990	L	6	3	Single	MES	Coil	—
998	L	6	0.1 amp.	Single	MES	Coil	—

FESTOON BULBS

Bulb No.	Illustration Reference	Volts	Watts	Contact	Cap
262	S	6	3	Double	Festoon, 31 × 8 mm.
263	S	12	3	Double	Festoon, 31 × 8 mm.
264	S	6	10	Double	Festoon, 44 × 15 mm.
265	S	12	10	Double	Festoon, 44 × 15 mm.
266	S	6	15	Double	Festoon, 44 × 15 mm.
267	S	12	15	Double	Festoon, 44 × 15 mm.

‡ For motor cycles rear lamps, up to and including 250 c.c. MES .. Miniature Edison screw cap MCC .. Miniature centre contact
 SBC .. Small bayonet cap SCC .. Single centre contact



FOG AND DRIVING LAMPS

MODEL SFT576 FOGLAMP

Ordering No. 54052141 — 12 volt

Comprises:		Part No.
Foglamp	55128E
Switch, model 65SA	31991A
Knob	314403
and cable (with Lucar connectors)		

Detailed Parts

§ Foglamp	55128E
<i>(All chrome finish—clear glass)</i>		
§ Light unit	554813
§ Bulb holder	54520352
§ Sleeve, terminal	555910
§ Bulb, 12 volt	323
§ Clamp, with cushion, light unit	535009
§ Cushion, clamp	534383
§ Screw, clamp fixing	144921
§ Nut, lamp fixing	180377
§ Washer, lock, fixing nut	188349
§ Base, lamp seating	534386
§ Bolt, lamp fixing	503014
§ Switch, model PS7	31201D
§ Nut, fixing, front	314017
§ Nut, fixing, rear	180093
§ Washer, spring	185081
§ Screw, terminal	120560
§ Switch, model 65SA	31991A
§ Nut, fixing	153601
§ Washer, fixing nut	54148517

Ordering No. 54052140 — 6 volt

Comprises:		Part No.
Foglamp	55127E
With switch and cable as 54052141		

Detailed Parts

§ Foglamp	55127E
<i>(All chrome finish—clear glass)</i>		
§ Bulb, 6 volt	173
<i>Other details as 55128E</i>		

Ordering No. 54052081 — 12 volt

Comprises:		Part No.
Foglamp (Details above)	55128E
Bracket	54052288
Switch, model 65SA, Lucar	31991A
and cable (with Lucar connectors)		

Ordering No. 54052080 — 6 volt

Comprises:		Part No.
Foglamp (Details above)	55127E
with bracket, switch and cable as 54052081		

Ordering No. 55133H — 23 volt

(All chrome finish—amber glass)

Detailed Parts		Part No.
§ Light unit	554820
<i>Other details as 55128E</i>		

Ordering No. 55130E — 6 volt

(All chrome finish—amber glass)

Detailed Parts		Part No.
§ Light unit	554820
§ Bulb, 6 volt	173
<i>Otherwise as 55128E</i>		

MODEL SLR576 DRIVING LAMP

Ordering No. 54052143 — 12 volt

Comprises:		Part No.
Long range driving lamp	55132E
Switch, model 65SA	31991A
and cable (with Lucar connectors)		

Detailed Parts

§ Long range driving lamp	55132E
<i>(All chrome finish—clear glass)</i>		
§ Light unit	554816
§ Bulb holder	54520352
§ Sleeve, terminal	555910
§ Bulb, 12 volt	185
§ Clamp, with cushion, light unit	535009
§ Cushion, clamp	534383
§ Screw, clamp fixing	144921
§ Nut, lamp fixing	180377
§ Washer, lock, fixing nut	188349
§ Base, lamp seating	534386
§ Bolt, lamp fixing	503014
§ Switch, model PS7	31201D
§ Nut, fixing, front	314017
§ Nut, fixing, rear	180093
§ Washer, spring	185081
§ Screw, terminal	120560
§ Switch, model 65SA	31991A
§ Nut, fixing	153601
§ Washer, fixing nut	54148517

Ordering No. 54052142 — 6 volt

Comprises:		Part No.
Long range driving lamp	55131E
With switch and cable as 54052143		

Detailed Parts

§ Long range driving lamp	55131E
<i>(All chrome finish—clear glass)</i>		
§ Bulb, 6 volt	172
<i>Other details as 55132E</i>		

Ordering No. 54052084 — 12 volt

Comprises:		Part No.
Long range driving lamp	55132E
<i>(Details above)</i>		
Bracket	54052288
Switch, model 65SA, Lucar	31991A
and cable (with Lucar connectors)		

Ordering No. 54052143 — 12 volt

Less bracket—otherwise as 54052084

Ordering No. 54052083 — 6 volt

Comprises:		Part No.
Long range driving lamp	55131E
<i>(Details above)</i>		
With bracket, switch and cable as 54052084		

Ordering No. 54052142 — 6 volt

Less bracket—otherwise as 54052083

Ordering No. 55145E — 12 volt

(All chrome finish—amber glass)

Detailed Parts		Part No.
§ Light unit	534365
<i>Other details as 55132E</i>		

Ordering No. 55144E — 6 volt

(All chrome finish—amber glass)

Detailed Parts		Part No.
§ Light unit	534365
§ Bulb, 6 volt	172
<i>Other details as 55132E</i>		

MODEL WFT576 FOGLAMP (back-fixing)

Ordering No. 54052082 — 12 volt

Comprises:		Part No.
Foglamp	55189B
Switch, model 65SA	31991A
and cable (with Lucar connectors)		

Detailed Parts

§ Foglamp	55189B
<i>(All chrome finish—clear glass)</i>		
§ Light unit	554813
§ Bulb holder	54520352
§ Sleeve, terminal	555910
§ Bulb, 12 volt	323
§ Clamp, light unit, with cushion	535009
§ Cushion, clamp	534383
§ Screw, clamp	144921
§ Cap, rubber	572363
§ Nut, lamp fixing	181261
§ Washer, shakeproof, nut fixing	188350
§ Plate, lamp fixing	534732
§ Washer, rubber, lamp seating	534722
§ Switch, model PS7	31201D
§ Nut, fixing, front	314017
§ Nut, fixing, rear	180093
§ Washer, spring	185081
§ Screw, terminal	120560
§ Switch, model 65SA	31991A
§ Nut, fixing	153601
§ Washer, fixing nut	54148517

Ordering No. 55197B — 6 volt

§ Foglamp	55197B
<i>(All chrome finish—clear glass)</i>		
§ Bulb, 6 volt	173
<i>Otherwise as 55189B</i>		

Ordering No. 55199B — 12 volt

§ Foglamp	55199B
<i>(All chrome finish—amber glass)</i>		
§ Light unit	554820
<i>Otherwise as 55189B</i>		

Ordering No. 55198B — 6 volt

§ Foglamp	55198B
<i>All chrome finish—amber glass)</i>		
§ Light unit	554820
§ Bulb, 6 volt	173
<i>Otherwise as 55189B</i>		

MODEL WLR576 DRIVING LAMP (back fixing)

Ordering No. 54052085 — 12 volt

Comprises:		Part No.
Long range driving lamp	55188B
Switch, model 65SA	31991A
and cable (with Lucar connectors)		

Detailed Parts

§ Long range driving lamp	55188B
<i>(All chrome finish—clear glass)</i>		
§ Light unit	554816
§ Bulb holder	54520352
§ Sleeve, terminal	555910
§ Bulb, 12 volt	185

FOG AND DRIVING LAMPS



Model WLR576—continued

Clamp, with cushion, light unit	535009
Cushion, clamp	534383
§ Screw, clamp	144921
Cap, rubber	572363
Nut, lamp fixing	181261
Washer, shakeproof, fixing nut	188350
Plate, lamp fixing	534732
Washer, rubber, lamp seating	534722
§ Switch, model PS7	31201D
Nut, fixing, front	314017
Nut, fixing, rear	180093
Washer, spring	185081
§ Screw, terminal	120560
§ Switch, model 65SA	31991A
Nut, fixing	153601
Washer, fixing nut	54148517

Ordering No. 55200B — 6 volt

§ Long range driving lamp	55200B
<i>(All chrome finish—clear glass)</i>	
§ Bulb, 6 volt	172
<i>Otherwise as 55188B</i>	

Ordering No. 55202B — 12 volt

§ Long range driving lamp	55202B
<i>(All chrome finish—amber glass)</i>	
§ Light unit	534365
<i>Otherwise as 55188B</i>	

Ordering No. 55201B — 6 volt

§ Long range driving lamp	55201B
<i>(All chrome finish—amber glass)</i>	
§ Light unit	534365
§ Bulb, 6 volt	172
<i>Otherwise as 55188B</i>	

MODEL 5FT "FOGRANGER"

Ordering No. 54052086 — 12 volt

<i>Comprises:</i>	
Foglamp	55213D
Bracket, lamp fixing	54520144
Switch, model 65SA	31991A
and cable (with Lucas connectors)	

Detailed Parts

§ Foglamp	55213D
§ Screw, rim fixing	127511
Washer, rim fixing screw	54520195
§ Light unit	54520142
§ Rim	54520057
§ Screw, fixing rim to light unit	198903
§ Bulb, 12 volt	323
§ Sleeve, terminal	555910
Nut, acorn, adjustment bolt	170801
Washer, shakeproof, acorn nut	188436
Bracket, retaining adjustment bolt	54520146
Tube, distance	54520145
Bolt, beam adjustment	54100561
Nut, lamp fixing	170494
Washer, shakeproof, fixing nut	188435
Bolt, lamp fixing	54100206
§ Switch, model PS7	31201D
Nut, fixing, front	314017
Nut, fixing, rear	180093
Washer, spring	185081
§ Screw, terminal	120560

Model 5FT—continued

§ Switch, model 65SA	31991A
Nut, fixing	153601
Washer, fixing nut	54148517

Ordering No. 55225B — 6 volt

<i>Detailed Parts</i>	
§ Bulb, 6 volt	173
<i>Other details as 55213D</i>	

MODEL 4FT FOGLAMP

Ordering No. 55169D — 12 volt

<i>(All chrome finish—clear glass)</i>	
<i>Detailed Parts</i>	
§ Rim or door	535091
§ Screw, rim fixing	127301
Screw, fixing, retaining plate	186137
Bracket, light unit retaining, top	54520655
Bracket, light unit retaining, bottom	54520654
§ Light unit	535303
Connection, earth	535099
§ Sleeve, terminal	188818
§ Bulb	325
Shield, bulb	552492
§ Grommet, cable entry	572363
Nut, bracket fixing	181261
Washer, shakeproof, fixing nut	188409
Washer, plain, fixing bolt	534928
Bolt, bracket fixing	520325
Bracket, lamp fixing	535078
§ Contact, bulb	535080

Ordering No. 55168D — 6 volt

<i>(All chrome finish—clear glass)</i>	
<i>Detailed Parts</i>	
§ Bulb	173
<i>Other details as 55169D</i>	

Ordering No. 55191D — 12 volt

<i>(All chrome finish—amber glass)</i>	
<i>Detailed Parts</i>	
§ Light unit	535182
<i>Other details as 55169D</i>	

Ordering No. 55190D — 6 volt

<i>(All chrome finish—amber glass)</i>	
<i>Detailed Parts</i>	
§ Light unit	535182
§ Bulb	173
<i>Other details as 55169D</i>	

MODEL 5LR "RANGER"

Ordering No. 54052087 — 12 volt

<i>Comprises:</i>	
Long range driving lamp	55212B
Bracket, lamp fixing	54520144
Switch, model 65SA	31991A
and cable (with Lucas connectors)	

Detailed Parts

§ Long range driving lamp	55212B
§ Screw, rim fixing	127511
Washer, rim fixing screw	54520195
§ Light unit	54520077
§ Rim	54520057
Screw, fixing rim to light unit	198903

Model 5LR — continued

§ Bulb, 12 volt	323
§ Sleeve, terminal	555910
Nut, acorn, adjustment bolt	170801
Washer, shakeproof, acorn nut	188436
Bracket, retaining adjustment bolt	54520146
Tube, distance	54520145
Bolt, beam adjustment	54100561
Nut, lamp fixing	170494
Washer, shakeproof, lamp fixing nut	188435
Bolt, lamp fixing	54100206
§ Switch, model PS7	31201D
Nut, fixing, front	314017
Nut, fixing, rear	180093
Washer, spring	185081
§ Screw, terminal	120560
§ Switch, model 65SA	31991A
Nut, fixing	153601
Washer, fixing nut	54148517

Ordering No. 55226B — 6 volt

<i>Detailed Parts</i>	
§ Bulb, 6 volt	173
<i>Other details as 55212B above</i>	

MODEL 4LR DRIVING LAMP

Ordering No. 55171D — 12 volt

<i>(All chrome finish—clear glass)</i>	
<i>Detailed Parts</i>	
§ Rim or door	535091
§ Screw, rim fixing	127301
Screw, fixing, retaining plate	186137
Bracket, light unit retaining, top	54520655
Bracket, light unit retaining, bottom	54520654
§ Light unit	535304
Connection, earth	535099
§ Sleeve, terminal	188818
§ Bulb	162
Shield, bulb	552492
§ Grommet, cable entry	572363
Nut, bracket fixing	181261
Washer, shakeproof, fixing nut	188409
Washer, plain, fixing bolt	534928
Bolt, bracket fixing	520325
Bracket, lamp fixing	535078
§ Contact, bulb	535080

Ordering No. 55170D — 6 volt

<i>(All chrome—clear glass)</i>	
<i>Detailed Parts</i>	
§ Bulb	172
<i>Other details as 55171D</i>	

Ordering No. 55193D — 12 volt

<i>(All chrome finish—amber glass)</i>	
<i>Detailed Parts</i>	
§ Light unit	535183
<i>Other details as 55171D</i>	

Ordering No. 55192D — 6 volt

<i>(All chrome finish—amber glass)</i>	
<i>Detailed Parts</i>	
§ Light unit	535183
§ Bulb	172
<i>Other details as 55171D</i>	



FLASHER SETS AND INSPECTION LAMP

MOTOR CYCLE FLASHER SETS

Part No.	54057021		
Model	628		
<i>Comprising</i>			
§ Flasher lamp			
Part No.	+53918A	‡53919A	‡53920A
	(2 off)		
Model	628	628	628
§ Flasher lamp	53733	53733	53733
§ Lens	535901	535901	535901
§ Nut, lens fixing	526567	526567	526567
§ Gasket, lens seating	535904	535904	535904
§ Bulb	317	317	317
§ Sleeve, terminal	555910	555910	555910
§ Grommet	199000	199000	199000
Base, with bulb holder	54570349	54570349	54570349
Nut, fixing bolt	177076	—	—
Clip, crash bar	54572219	—	—
Liner, crash bar clip	54572217	—	—
Washer, shakeproof	188319	—	—
Screw, backshell fixing	54572534	—	—
Backshell, lamp	54572215	—	—
Bolt, lamp fixing	54101366	—	—
Washer, fixing bolt	54572535	—	—
Screw, lamp fixing	—	54101351	54101351
Washer, fixing screw	—	188341	188341
Bracket, lamp fixing	—	54572021	54572021
§ Plinth, lamp seating	—	54572144	54572144

Flasher unit	Part No.	*35025A
Model		(35013)
		FL5
§ Screw, terminal		132464
§ Washer, terminal screw		185000
Warning light		
Part No.		38193A
Model		WL13
Shade		305569
§ Window		319303
§ Bulb		990
§ Bulb holder		554734
Flasher switch		
Part No.		31993A
Model		52SA
Nut, fixing		153631
Clip		54333714
		Part No.
§ Spring, mounting		54380121
Washer		185040
§ Bolt		106811
Nut		166016
§ Connector		850641
§ Connector		900288
§ Terminal		900269
§ Terminal		861900

SCOOTER FLASHER SET

Part No.	54057078		
Model	628		
<i>Comprising</i>			
Flasher lamp			
Part No.	53974A	‡53919A	‡53920A
Model	628	628	628
§ Lens	535901	—	—
§ Nut, lens fixing	526567	—	—
§ Gasket, lens seating	535904	—	—
§ Bulb	317	—	—
§ Sleeve, terminal	555910	—	—
§ Grommet, cable entry	199000	—	—
Base, with bulb holder	54570349	—	—
§ Gasket, mounting lamp	54571577	—	—
Screw, lamp fixing, short	132527	—	—
Screw, lamp fixing, long	132627	—	—
Washer, fixing screw	188341	188341	188341
§ Flasher lamp	—	53733	53733
§ Lens	—	535901	535901
§ Nut, lens fixing	—	526567	526567
§ Gasket, lens seating	—	535904	535904
§ Bulb	—	317	317
§ Sleeve, terminal	—	555910	555910
§ Grommet, cable entry	—	199000	199000
Base, with bulb holder	—	54570349	54570349
Screw, lamp fixing	—	54101351	54101351
Bracket, lamp fixing	—	54572021	54572021
§ Plinth, lamp seating	—	54572144	54572144

§ Flasher unit	Part No.	*35025A
Model		(35013)
		FL5
§ Screw, terminal		132464
§ Washer, terminal screw		185000
§ Switch		
Part No.		34431A
Model		94SA
Lever, with screw		54339152
Screw		101371
§ Bulb		382
Screw, terminal		122549
Pad, mounting		54336190
Clip, spring mounting flasher unit		54380121
Washer		185040
Bolt		106811
Nut		166016
Connector		850641
Terminal		861900
Terminal		900269
Screw, switch fixing		198871

INSPECTION LAMP

Part No.	060120 (6 volt)
Model	060121 (12 volt)
	100
Screw, bulb guard fixing	635453
Guard, bulb	534790
§ Bulb, 6 volt	109
§ Bulb, 12 volt	5
Nut, hook guide	166160
§ Screw, grub, socket	534781

* When ordering, quote part number shown in brackets † Crash bar fitting ‡ Number plate fitting § Recommended spares for stock || Front fitting

LIGHTING

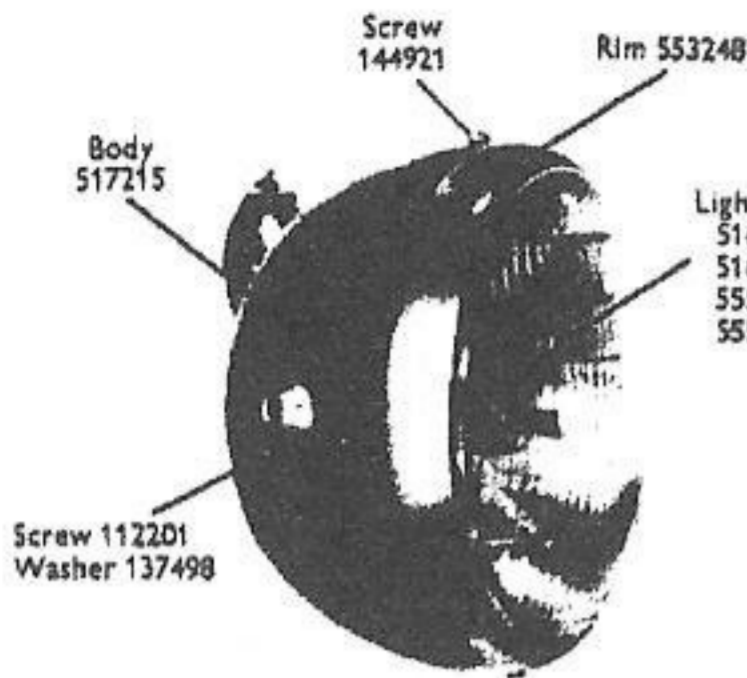

Screw 112201
Washer 137498

MODEL MCH60

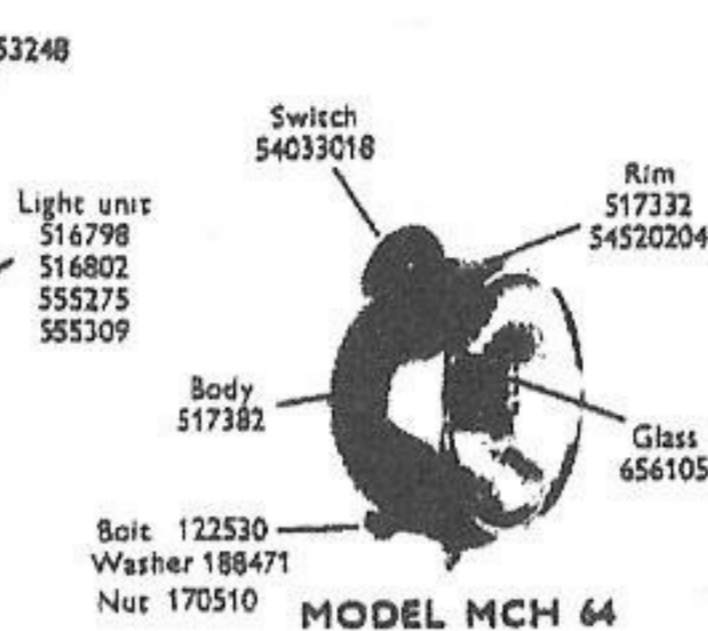

Body 517382
Bolt 122530
Washer 188471
Nut 170510

MODEL MCH 64

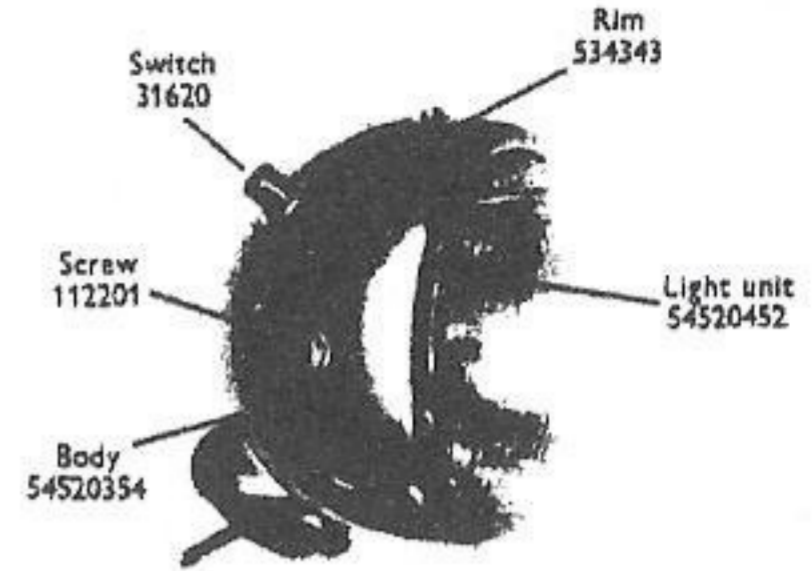

Switch 31620
Screw 112201
Body 54520354

MODEL MCH 66



553780



534296



517333



517296



656118



552943



554602



573828

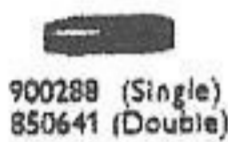

900288 (Single)
850641 (Double)



144921

524911



504665



199003



859060

Clip and screw 562306

562306

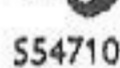

554710

Rubber cushion 517304



517388

Ring 554354

554354

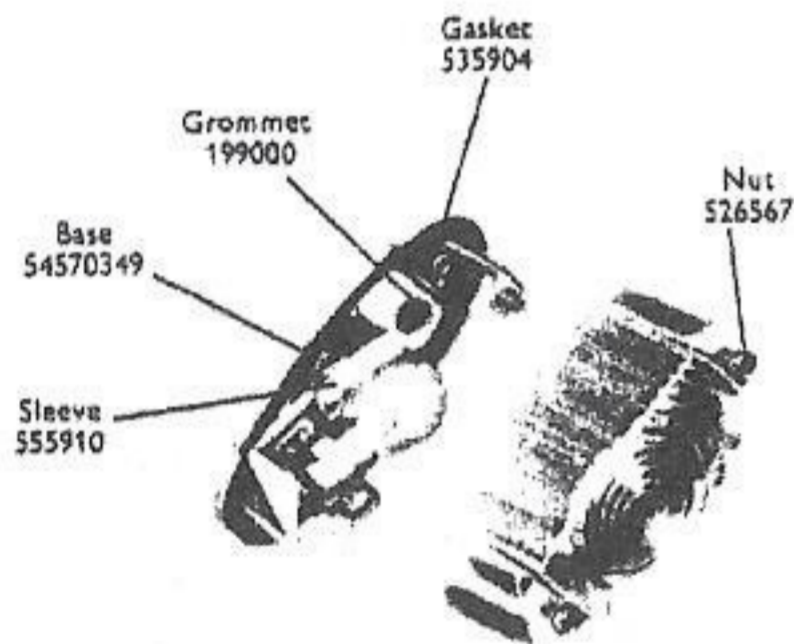

MODEL 628



35013
35020

199002

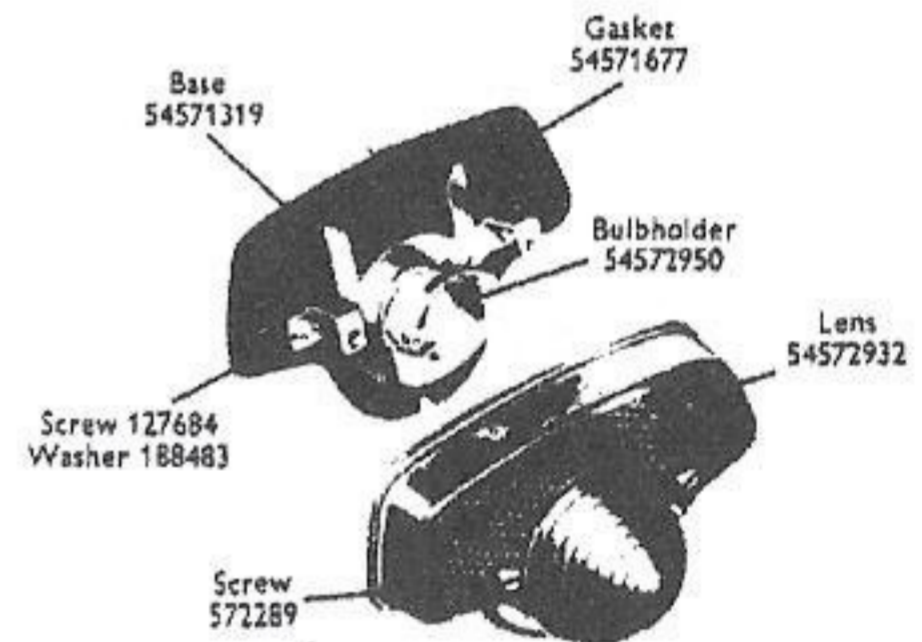

MODEL 679

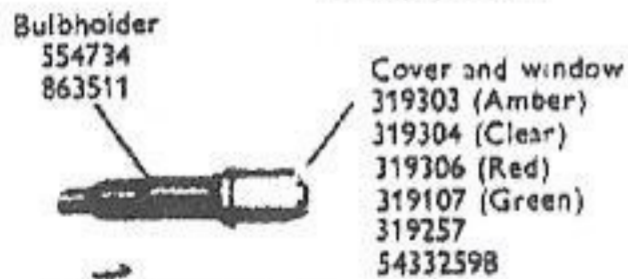

MODEL WL 13



54945043

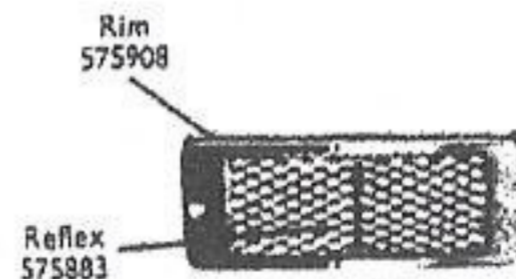

MODEL RER 22

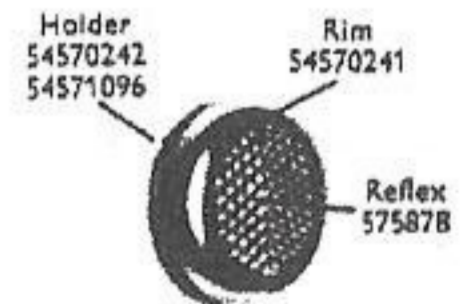

MODEL RER 25



319222



305569



319203



319204



MODEL WL 15



(Red) 319335
(Green) 54360213



319220



319214



X



Y



MODEL WFT 576



MODEL WLR 576

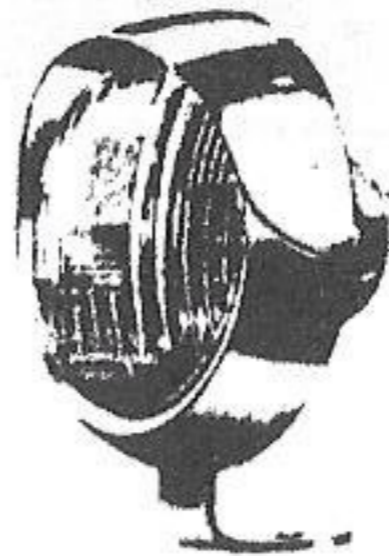

MODEL 4 FT



MODEL 4 LR



MODEL 5 FT



SPOTLIGHT BRACKET FOR CRASH BAR FITTING



MODEL 5 LR

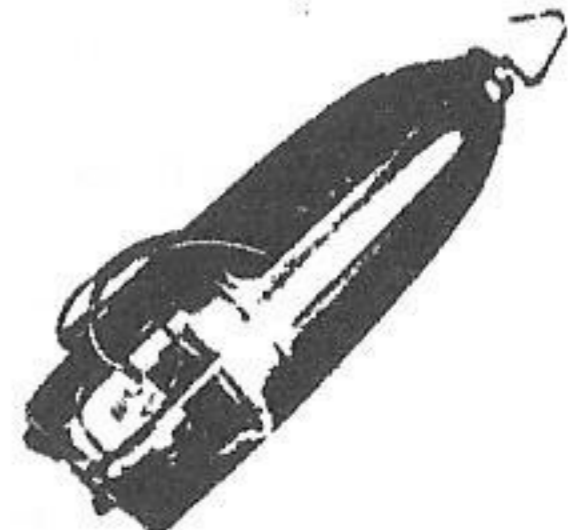

MODEL 100



MODEL 628
MOTOR SCOOTER FLASHER SET

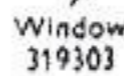
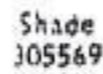
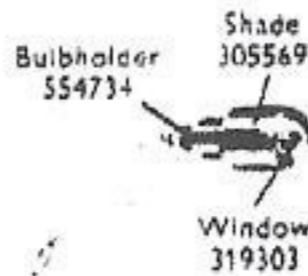

31993



Flasher unit
FL 5



MODEL 628
MOTOR CYCLE FLASHER SET

CONTENTS

<i>Description</i>	<i>Page</i>
Dipper and Indicator Switches	
Detailed parts	H2
Horn Pushes and Dipper Switches	H2
Lighting Switches	
Detailed parts	H2-3
Stop Lamp and Starter Switches	
Detailed parts	H3
Lighting and Ignition Switches	
Detailed parts	H3
Ignition Switches	
Detailed parts	H4
Cutout and Magneto Switches	
Detailed parts	H4



DIPPER, INDICATOR AND LIGHTING SWITCHES—HORN PUSHES

DIPPER AND INDICATOR SWITCHES

DETAILED SPARE PARTS

Part No. Model Replaced by	*31278A 99 (31482)	31482A 9 —	*31549A/B 99 (31482)	31620A/B PS9 —	31820A 68SA —	31823A 52SA —
Clip	380427	380427	380427	—	—	—
§Screw or nut, fixing	121964	—	121964	314540	—	153630
§Screw, terminal	—	120610	—	120560	—	—

HORN PUSHES AND DIPPER SWITCHES

DETAILED SPARE PARTS

Part No. Model	*31563A/D 25SA	76204A/D 4A	76206E 4A	76210A/D 4A
Button and cover	380660	—	—	—
Base and lever	380658	—	—	—
§Screw, terminal	120610	119520	119520	119520
Clip, fixing	—	762229	—	762250
Screw, clip fixing	—	135480	135480	135480
Nut, clip fixing	—	153491	—	153491

NOTE. Horn pushes 76200, *76207, *76209 and *76234 have no serviceable spare parts.

LIGHTING SWITCHES

DETAILED SPARE PARTS

Part No. Model Replaced by	*31276A/B PS6 (31356)	31315A U39 —	31340A U39 —	31356A/B PS6 —	31371A/D RS39 —	*31491A U39 (31684)	*31626A 41SA (31676)
§Handle or knob	—	351724	351567	—	351567	351567	351788
Screw, fixing	—	126544	126544	—	126544	126544	126544
Washer, fixing screw	—	188408	188408	—	188408	188408	188408
Spring or nut, switch fixing	180670	308234	308234	180670	166043	308234	180114
Washer, plain, fixing nut	158350	—	—	158350	—	—	187500
Washer, spring, fixing nut	185188	—	—	185188	185040	—	—
Shaft headpiece or spindle and action plate	—	351501	351501	—	351501	351773	351789
Roller or rotor, contact	—	351660	351660	—	351660	351660	351660
Plunger, contact	—	351661	351661	—	351661	351661	351661
Spring	—	351662	351662	—	351662	351662	351662
Ring, retaining	—	523986	523986	—	523986	523986	—
Lever, contact	—	—	—	—	—	351528	—
§Screw, terminal	121610	120560	120560	121610	120560	120560	120560
Nut, contact stud	—	166103	166103	—	—	166103	—

Part No. Model Replaced by	31676A 41SA —	31684A U39 —	31718A/D 41SA —	31721A/B 41SA —	*31754A/B 41SA (31763)	31758A/D 41SA —	31763A/B 41SA —
§Handle or knob	351788	351724	351815	351815	351815	351815	351815
Screw, fixing	105751	126544	127301	127301	127301	127301	127301
Washer, fixing screw	188408	188408	185038	185038	185038	185038	185038
Spring or nut, switch fixing	180114	308234	173777	173777	173777	173777	173777
Washer, plain, fixing nut	187500	—	188303	188303	188303	188303	188303
Bezel	351768	—	—	—	—	—	—
Shaft headpiece or spindle and action plate	351789	351773	351789	351821	351789	351824	351789
Roller or rotor, contact	351660	351660	351660	351660	351660	351660	351660
Plunger, contact	351661	351661	351661	351661	351661	351661	351661
Spring	351662	351662	351662	351662	351662	351662	351662
Ring, retaining	—	523986	—	—	—	—	—
Lever, contact	—	351528	—	—	—	351528	—
§Screw, terminal	120560	120560	120560	120560	120560	120560	120560
Nut, contact stud	—	166103	—	—	—	—	—

* When ordering, quote part number shown in brackets

§ Recommended spares for stock

LIGHTING, STOP LAMP, STARTER & IGNITION SWITCHES



LIGHTING SWITCHES—continued DETAILED SPARE PARTS

Part No. Model Replaced by	*31766A/D 41SA (54033018)	31777A 41SA	31784A/D 41SA	34289A 88SA	54033004 63SA	54033018 61SA	54033028 63SA	54033109 63SA
§Handle or knob	—	351788	351815	—	—	—	—	—
Screw, fixing	—	105751	127301	—	—	—	—	—
Washer, fixing screw	—	188408	185038	—	—	—	—	—
Spring or nut, switch fixing	180316	180114	173777	180316	—	180316	—	—
Washer, plain fixing nut	—	187500	188303	—	—	—	—	—
Washer, spring, fixing nut	185128	—	—	185128	—	185128	—	—
Shaft headpiece or spindle and action plate	54331427	351794	54330517	—	—	54331427	—	—
Roller or rotor, contact	332489	351660	351660	—	—	332489	—	—
Plunger, contact	—	351661	351661	—	—	—	—	—
Spring	332496	351662	351662	—	—	332496	—	—
Ring, retaining	154390	—	—	—	—	154390	—	—
Lever, contact	—	351528	351528	—	—	—	—	—
§Screw, terminal	—	120560	120560	—	—	—	—	—
§Socket, with cables	—	—	—	‡54930007	—	—	—	—
§Connector, snap	—	—	—	—	900269	900269	900269	900269
§Connector, tube, single	—	—	—	—	900288	900288	900288	900288
§Connector, tube, double	—	—	—	—	—	—	850641	—
Cover, rubber	—	—	—	—	332521	—	332521	332521

STOP LAMP AND STARTER SWITCHES DETAILED SPARE PARTS

NOTE. Stop lamp switches 31383, 31384, †31437, 31511 and 34381 have no serviceable spare parts.

Part No. Model	31281B 54C	31688A/B 6SA	31827A/B 6SA	34257A/B 6SA	34448A 6SA
§Screw, terminal or fixing	120560	—	—	—	—
Cover, rubber, terminal	—	360363	—	360363	360363
§Sleeve, terminal	—	188818	188818	188818	188818

Part No. Model Replaced by	76442A/B 4SA	*76463A 4SA (76442)	54033234 22B	54033235 22B
Fixing bracket	—	—	317578	317578
§Screw, terminal or fixing	—	—	126504	127824
Nut, terminal or fixing	172580	156610	166014	166014
Washer, spring	185053	185053	185040	185040

SPRINGS

For use with 22B and 54C stop lamp switches.

Part No.	315543	315738	315774	317577
Overall dimension	3 $\frac{1}{8}$ "	2 $\frac{1}{8}$ "	1 $\frac{3}{8}$ "	3"

LIGHTING AND IGNITION SWITCHES DETAILED SPARE PARTS

Part No. Model Replaced by	31443A/E PRS8	*31460A PRS8 (31443)	34080A PLC5
§Key	318341	318341	344715
§Screw, terminal	120584	120584	120560
Screw, knob fixing	319333	319333	—
Grommet	318323	318323	—
Rotor, lighting	313053	313053	—
Base, lighting	318314	318314	—
Terminal, lighting	318349	318349	—
Rotor, ignition	313052	313052	—
Terminal, ignition	318316	318316	—
Nut, fixing	180670	180670	—
Cap and plate	318331	318331	—
Screw, body fixing	198887	198887	—
Nut, spindle	169294	169294	—
Ignition cap cover	—	—	344729

* When ordering, quote part number shown in brackets

† See Supersession Chart

‡ Order separately

§ Recommended spares for stock

LUCAS

J

Original Part No.	Replaced by	Original Part No.	Replaced by
20010	20036	47568	47572
26501	54025006	47580	425379
31071	31107	50791	51625
31276	31356	51686	51829
31278	31482	51706	51709
31376	31107	51788	51832
31437	54033234	51801	58091
31460	31443	51876	51954
31491	31684	57048	57131
31549	31482	58209	58224
31626	31676	70037	54068036
31754	31763	70039	54068034
31766	54033018	70106	54068034
36189	36129	70136	70048
36220	36184	70137	70048
38065	38059	70146	70142
38134	38049	70147	70151
38197	38118	70148	70048
39517	301187	70152	70156
40466	40712	70153	70155
40486	40426	70157	70142
40529	40699	76207	76200
40550	40610	76209	76200
40621	40701	76234	76200
40669	40702	76463	76442
42248	42379	319335	319106 and 319222
42263	42380		
42264	42380	319383	319107 and 319222
42330	42281		
42347	42371	468677	466168
47111	47132	839102	839101
47138	47175	54360213	319107 and 319222
47141	47176		
47143	47177	54941657	54033240

LUCAS

K

This section provides a complete record of all part numbers appearing in this catalogue. In the case of complete units, only one reference is made to Section A, Equipment Specifications, although in fact a particular unit may appear many times throughout this section against various motor cycles.

Part No.	Page No.	Part No.	Page No.	Part No.	Page No.	Part No.	Page No.	Part No.	Page No.
5	G30	955	G27	31718	A13, H2	40529	A18, F5	47134	A5, D2
109	G30	956	G27	31721	A12, H2	40550	A10, F5	47135	A5, D2
162	G29	970	G27	31754	A1, H2	40573	A19, F5	47136	A5, D2
163	G26	974	G27	31758	A11, H2	40589	A2, F5	47137	A3, D2
166	G26	977	G27	31763	A1, H2	40599	A6, F5	47138	A5, D2
168	G26	987	A17, G27	31766	A18, H3	40610	A10, F5	47141	A5, D2
169	G26	988	G27	31777	A4, H3	40621	A5, F5	47143	A5, D2
172	G26	989	G27	31784	A2, H3	40628	A16, F5	47149	A20, D2
173	G26	990	A17, G27	31820	A3, H2	40646	A19, F4	47154	A1, D2
180	G26	998	B1, G27	31823	A3, H2	40664	A19, F4	47161	A3, D2
185	G28	GUZ11E	A4, B2	31827	A5, H3	40669	A6, F4	47162	A17, D2
190	G27	LV5E	B2	31991	G28	40690	A21, F4	47164	A8, D2
200	G27	MKZ9E	A11, B2	31993	G30	40699	A6, F4	47165	A20, D2
204	G27	PUZ5E	B2	33141	C1	40700	A19, F5	47171	A21, D2
205	G27	PUZ5E/10	A12, B2	34080	A18, H3	40701	A5, F5	47173	A6, D2
206	G27	PUZ5E/11	A4, B2	34093	A8, H4	40702	A6, F5	47174	A5, D2
222	G27	PUZ7E/4	B2	34257	A6, H3	40710	A20, F5	47175	A5, D2
262	G27	PUZ7E/9	A3, B2	34287	A1, H4	40712	A8, F4	47176	A5, D2
263	G27	PUZ7E/10	A3, B2	34289	A1, H3	40820	A20, F5	47177	A5, D2
264	G27	PUZ7E/11	A1, B2	34381	A20, H3	42123	A6, F9	47178	A21, D2
265	G27	RUZ7E	B2	34427	A3, H4	42133	A21, F7	47181	A16, D2
266	G27	SCZ7E	B2	34431	G30	42157	A4, F9	47182	A16, D2
267	G27	MLZ9E	A1, B2	34448	A7, H3	42183	A18, F7	47183	A21, D2
281	A21, G27	MKZ5E	B2	35013	A3, G30	42230	A2, F7	47502	A20, F6
282	G27	20010	A4, D1	35020	A21	42248	A4, F7	47503	A4, F6
307	G26	20034	A3, D1	35025	G30	42263	A7, F7	47508	A17, F6
311	G26	20035	A2, D1	36084	A1, B1	42264	A2, F7	47545	A21, F6
312	G26	20036	A7, D1	36129	A19, B1	42272	A10, F8	47553	A10, F6
317	G27	20038	A1, D1	36184	A17, B1	42281	A8, F6	47556	A8, F6
319	G27	22011	A4, D1	36189	A19, B1	42298	A20, F8	47568	A5, F2
323	G28	26501	A5, F3	36220	A4, B1	42324	A20, F9	47571	A8, F2
325	G29	26504	A21, F1	36296	A2, B1	42330	A8, F6	47572	A5, F2
350	G26	31071	A17, H4	37097	C1	42344	A20, F8	47574	A13, F2
352	G27	31083	A4, H4	37144	A1, C1	42346	A21, F9	47576	A21, F6
373	G26	31107	A4, H4	37221	A6, C1	42347	A1, F9	47578	A1, F2
377	G26	31201	G28	37225	A2, C1	42348	A6, F9	47579	A1, F2
378	G26	31276	A6, H2	37228	C1	42349	F10	47580	A3, F2
380	G27	31278	A18, H2	37232	A1, C1	42350	A16, F10	47583	A5, F2
382	G27	31281	A7, H3	37252	A2, C1	42364	A10, F6	47591	A21, F2
383	G27	31315	A4, H2	37288	C1	42368	A17, F10	47595	A1, F2
384	G27	31340	A1, H2	38049	A17, G25	42369	A11, F8	50791	A1, G2
386	G26	31356	A6, H2	38059	J1	42371	A1, F10	50943	A8, G18
387	G26	31371	A20, H2	38118	A5, G25	42372	A4, F6	51112	A8, G18
388	G26	31376	A20, H4	38134	A17, G25	42376	A18, F6	51134	A8, G18
389	G26	31383	A16, H3	38184	A4	42379	A7, F7	51519	A5, G18
391	G26	31384	A1, H3	38187	A3, G25	42380	A2, F7	51547	A19, G18
392	G26	31437	A3, H3	38188	A3, G25	42413	A7, F8	51548	A19, G18
393	G26	31443	A1, H3	38192	A21, G25	42417	A14, F10	51625	A1, G2
394	G26	31460	A2, H3	38193	A3, G25	45077	A1, F3	51628	A2
395	G26	31482	A1, H2	38194	A3, G25	45101	A5, F3	51632	A6, G2
403	G26	31491	A8, H2	38197	A5, G25	45112	A6, F3	51634	A19, G19
425	G26	31511	A11, H3	38198	A5, G25	46047	A15, F11	51686	A6, G2
602	G26	31549	A3, H2	39517	A3	46048	A6, F11	51706	A18, G2
640	G27	31563	A1, H2	40145	A18, F4	46049	A8, F11	51709	A18, G2
641	G27	31620	A2, H2	40352	A21, F4	46051	A4, F11	51750	A8, G19
643	G27	31626	A15, H2	40426	A4, F4	47111	A1, D2	51751	A10, G2
659	G26	31676	A15, H2	40449	A21, F4	47122	A1, D2	51756	A8, G19
950	G27	31684	A8, H2	40466	A8, F4	47128	A5, D2	51757	A20, G19
951	G27	31688	A8, H3	40486	A4, F5	47132	A1, D2	51758	A20, G19



NUMERICAL INDEX

Part No.	Page No.	Part No.	Page No.	Part No.	Page No.	Part No.	Page No.	Part No.	Page No.
51788	A6, G2	58016	A16, G4	58418	A5, G22	70164	A5, E2	127584	D1
51801	A18, G3	58017	A16, G5	58419	A5, G22	70169	A3, E2	127684	G24
51820	A3, G19	58018	A16, G5	58420	A5, G22	70174	E3	127824	H3
51829	A6, G2	58019	A15, G5	58421	A5, G22	70175	E3	128013	D2
51832	A6, G2	58020	A15, G5	58422	A5, G22	76200	A3, H2	128433	G11
51845	A5, G3	58021	A15, G5	58423	A5, G22	76204	A1, H2	130251	G3
51846	A5, G3	58037	A18, G6	58424	A5, G22	76206	A6, H2	131023	D2
51847	A5, G3	58091	A18, G6	58432	A2, G13	76207	A3, H2	131674	E1
51854	A6, G3	58092	A18, G6	58442	A18, G13	76209	A8, H2	132464	G30
51856	A8, G19	58094	A11, G6	58470	A17, G13	76210	A18, H2	132504	C1
51860	A20, G19	58103	A16, G6	58471	A17, G14	76234	A3, H2	132527	G30
51876	A15, G3	58104	A16, G6	58472	A17, G14	76442	A5, F3	132627	G30
51890	A5, G3	58111	A12, G6	58475	A17, G22	76463	A5, H3	133231	G24
51892	A20, G3	58112	A13, G6	58477	A2, G14	78105	A11, F3	133303	G2
51929	A3, G20	58124	A16, G6	58483	A17, G14	78106	A4, F3	133551	G24
51930	A3, G20	58125	A16, G6	58514	A1, G14	78118	A11, F3	133724	G26
51931	A3, G20	58126	A16, G6	58515	A1, G14	78119	F3	135120	G26
51932	A3, G20	58127	A16, G8	58516	A2, G14	78120	F3	135423	F9
51954	A15, G4	58135	A1, G8	58517	A2, G15	78134	F3	135444	F9
51997	A13, G4	58136	A1, G8	58518	A2, G15	053271	G28	135480	H2
52233	A7, G25	58137	A1, G8	58519	A2, G15	053272	G28	137060	C1
52234	A8, G25	58138	A1, G8	58552	A17, G23	053276	G28	137141	G2
52268	A6, G25	58147	A5, G9	58556	A3, G15	053277	G28	137497	G11
53256	A8, G24	58149	A12, G9	58583	A16, G15	053311	G28	137498	G2
53324	A7, G24	58150	A13, G9	58584	A16, G15	053312	G28	138453	E1
53331	A11, G24	58151	A2, G9	58586	A2, G15	053315	G29	140074	D1
53394	A3, G24	58152	A2, G9	58597	A16, G15	053316	G29	140079	F6
53428	A19, G24	58153	A2, G9	58598	A16, G15	056117	G28	141666	E1
53429	A1, G24	58154	A2, G9	58599	A16, G15	060120	G30	142725	E3
53432	A1, G24	58155	A12, G9	58627	A21, G23	060121	G30	144406	F6
53454	A5, G24	58156	A16, G9	58670	A3, G16	069239	A4, E2	144426	F6
53555	A4, G24	58157	A16, G10	58672	A3, G16	069424	A8, E2	144500	E1
53733	A3, G25	58158	A6, G20	58673	A3, G16	069446	A1, E2	144769	F6
53825	A6, G24	58159	A6, G20	58702	A1, G16	069468	A6, E2	144921	G2
53918	G30	58160	A6, G20	58704	A2, G16	069482	A7, E2	145231	G25
53919	G30	58161	A6, G20	58761	A17, G16	069483	A6, E2	145389	F6
53920	G30	58162	A11, G10	58829	A2, G23	069498	A18, E2	145481	E1
53972	A14, G24	58169	A6, G10	58830	A3, G16	069508	A5, E2	145491	E1
53974	G30	58170	A6, G10	58831	A3, G16	100384	C1	145904	F2
53977	A21, G25	58171	A6, G10	58832	A1, G17	100394	G24	146240	G25
55127	G28	58172	A6, G10	58833	A1, G17	100521	G25	149010	F11
55128	G28	58174	A11, G11	58859	A6, G17	100614	F7	153491	H2
55130	G28	58177	A23, G11	58878	A20, G17	101270	F8	153601	G28
55131	G28	58178	A2, G11	58885	A16, G17	101371	G30	153630	H2
55132	G28	58179	A2, G11	58892	A3, G17	102494	F6	153631	G30
55133	G28	58180	A2, G11	58893	A3, G17	105751	H2	154390	G18
55144	G28	58180	A2, G11	58893	A3, G17	110714	A18	154660	F6
55145	G28	58197	A16, G11	58896	A3, G17	110734	F11	156610	H3
55168	G29	58198	A4, G11	58897	A3, G23	110739	F8	156654	C1
55169	G29	58204	A3, G21	58898	A3, G23	111591	F7	158350	H2
55170	G29	58208	A6, G11	58899	A3, G23	111704	D1	161020	G24
55171	G29	58209	A6, G11	58900	A21, G23	111950	E3	161353	F2
55188	G28	58210	A6, G11	58934	A20, G17	112201	G2	161385	G21
55189	G28	58211	A6, G12	58935	A19, G17	112756	G11	161673	F7
55189	G28	58215	A13, G12	58937	A14, G17	113030	E1	161681	F7
55190	G29	58216	A13, G12	70037	E1	116141	G25	161728	F11
55191	G29	58224	A1, G11	70039	E1	119520	H2	163343	F7
55192	G29	58234	A5, G21	70048	A1, E1	120560	G2	164334	F7
55193	G29	58241	A16, G12	70106	E2	120584	H3	164680	F11
55197	G28	58258	A3, G21	70136	A2, E1	120610	H2	164724	F7
55198	G28	58259	A13, G12	70137	A1, E1	121610	B1	165033	F6
55199	G28	58339	A11, G12	70140	A16, E1	121964	H2	165498	E1
55200	G29	58348	A13, G13	70141	A21, E1	122160	F7	166014	G21
55201	G29	58349	A13, G13	70142	A1, E1	122530	G18	166016	G30
55202	G29	58354	A2, G13	70145	A4, E1	122549	G30	166019	A18
55212	G29	58374	A16, G13	70146	A1, E1	123022	F4	166032	E1
55213	G29	58382	A5, G21	70147	A11, E1	123063	D1	166043	B1
55225	G29	58383	A12, G21	70148	A19, E1	123154	F4	166094	F2
55226	G29	58391	A5, G21	70151	A11, E1	125533	G24	166103	G2
57048	A8, G26	58392	A5, G21	70152	A5, E1	126504	F2	169160	D1
57080	A19, G26	58395	A6, G13	70153	A5, E1	126544	C1	169194	F2
57098	A11, G26	58396	A3, G21	70155	A5, E1	126589	A18	169294	H3
57110	A7, G26	58397	A3, G21	70156	A5, E1	126881	F2	170090	F9
57116	A1, G26	58404	A16, G13	70157	A3, E2	127301	H2	170104	D1
57131	A8, G26	58409	A1, G13	70162	A11, E2	127511	G29		
58015	A16, G4	58417	A5, G22	70163	A1, E2				

NUMERICAL INDEX



Part No.	Page No.	Part No.	Page No.	Part No.	Page No.	Part No.	Page No.	Part No.	Page No.
170109	D1	189386	F11	261233	F3	391346	C1	423486	F4
170124	F7	189781	C1	291655	F3	391347	C1	423506	A1, D1
170494	G29	198871	G30	301187	A3	391453	C1	423571	F4
170510	G18	198877	G26	305569	G25	391454	C1	423759	F4
170801	G29	198887	H3	308234	G2	397092	G3	424123	F5
171714	F6	198898	G21	312305	H4	397106	G3	424151	F5
172580	F3	198903	G29	313052	H3	400001	F4	424158	F4
173777	H2	199000	G25	313053	H3	400034	F4	424670	F2
173974	F11	199001	G11	314017	G28	400051	F5	424967	F4
175300	G26	199002	G17	314026	G28	400052	F4	424971	F2
177014	G8	199003	G13	314403	G28	400135	F4	424972	F4
177076	G30	199005	G4	314540	H2	400136	F4	424974	F5
178931	E1	199218	B7	315543	A1, H3	400164	F4	425049	F4
180093	G28	199275	B7	315738	A17, H3	400308	F4	425219	F4
180114	H2	199279	B7	315774	A8, H3	400415	F4	425243	F4
180170	G25	199317	B7	317577	A4, H3	400843	F4	425251	F2
180316	G18	200188	D1	317578	A18, H3	401092	F4	425284	F4
180377	G28	200224	D1	318314	H3	401119	F4	425298	F2
180396	D1	200227	D1	318316	H3	402101	F4	425370	F2
180670	H2	200229	D1	318323	H3	404435	F4	425377	F2
180676	H4	200262	D1	318331	H3	405314	F4	425378	F2
181261	G25	200378	D1	318341	H3	405588	F4	425379	A3, F2
184000	E1	200379	D1	318344	G7	406105	F4	425382	F2
184011	H4	200380	D1	318346	A1, G4	406699	F4	425398/S	F4
185000	G30	200382	D1	318349	H3	407019	F6	425444	F4
185012	G2	200609	D1	318352	G28	407131	F2	425498	F4
185026	G3	200708	D1	318864	G25	407256/S	F6	425596	F5
185038	C1	200709	D1	318896	G25	407932	F4	425598	F5
185040	A18, B1	200712	D1	318942	G7	410600	F4	425733	F2
185051	E3	200713	D1	319106	A17, G25	415087	F5	425746	F5
185053	F3	200731	D1	319107	A17, G25	415283	F4	425833	F2
185061	C1	200732	D1	319203	G25	415729	F2	450426	F7
185081	G28	200737	D1	319204	G25	415730	F4	451260	F7
185085	G25	200738	D1	319214	G25	416047/S	F5	451315	F8
185128	G18	200748	D1	319220	G25	416136	F2	451378	F6
185188	H2	200752	D1	319222	A17, G25	417198	F4	451379	F6
186060	F7	200754	D1	319257	G25	417497	F4	452906	F9
186092	D2	200760	D1	319303	G25	419645	F4	452907	F8
186128	G2	200799	D1	319304	G25	419950	F2	454385	F8
186130	G2	200800	D1	319333	H3	420151	F5	454415	F8
186136	G11	200802	D1	319335	A17, G25	420196	F2	454467	F8
186137	G21	200805	D1	319383	A17, G25	420261	F4	454472	F7
186157	G12	200806	D1	332489	G18	420406	F4	454475	F7
186471	F11	200826	D1	332496	G18	420409	F4	454492	F8
187110	G2	200829	D1	332521	H3	420691	F4	454495	D1
187117	G21	200895	D1	335767	C1	421047	F5	454496	F7
187500	H2	200907	F11	336454	C1	421054	F4	454497	F8
188152	G11	200908	D1	344715	H3	421056/S	F4	454694	F8
188303	H2	200911	D1	344729	H3	421102	F4	454697	F8
188319	G30	200912	D1	351501	G2	421103	F4	454969	F7
188327	G24	200923	D1	351528	G2	421106	F4	455190	F7
188329	G8	200924	D1	351567	A4, H2	421109	F4	455191	F7
188330	F3	220197	D1	351660	G2	421112	F4	455233	F9
188341	G30	220383	D1	351661	G2	421327	F4	455340	F7
188349	G28	220475	D1	351662	G2	421414	F4	455347	F8
188350	D1	220480	D1	351724	H2	421415	F4	455361	F7
188408	H2	220487	D1	351768	G7	421457	F2	455622	F7
188409	G29	220498	F4	351773	G2	421538/S	F4	455634	F7
188412	G2	220516	D1	351788	H2	421554	F3	455733	F7
188435	G29	220556	D1	351789	H2	421561	F4	455734	F7
188436	G29	220557	D1	351794	H3	421569	F4	455788	F7
188471	G18	220566	D1	351803	A7, G6	421625	F4	455791	F9
188483	G24	220569	D1	351815	A16, G6	421863	F3	456727	F9
188614	D1	220572	D1	351821	H2	421935	F4	456794	F7
188618	D1	220575	D1	351824	H2	422381	F5	457117	F9
188639	F4	220593	D1	360363	A5, H3	422584	F4	457681	F8
188643	F5	220643	D1	365421	B1	422650	F4	457810	F9
188818	G2	226212	C1	369201	B1	422655/S	F4	458020	F6
189210	D1	226289	C1	380427	H2	422659	F4	458021	F6
189244	F7	226339	C1	380459	A17	423108	F4	458028	F6
189285	D1	226363	C1	380658	H2	423109	F4	458044	F6
189289	F6	226364	C1	380660	H2	423110	F4	458045	F6
189291	F6	253070	F3	390387	C1	423113	F4	458046	F6
189294	F8	253131	F3	390529	C1	423121	F5	458053	F6
189307	D1	261084	F3	390794	C1	423153	F2	458194	F6



NUMERICAL INDEX

Part No.	Page No.	Part No.	Page No.	Part No.	Page No.	Part No.	Page No.	Part No.	Page No.
458333	F7	463932	F8	493836	F8	517408	G18	553435	G2
458339	F7	463944	F7	496005	F2	517513	G6	553470	G21
458346	F7	463983	F8	496085	F4	517515	G6	553568	G3
458356	F7	463989	F11	498131	F6	517516	G6	553780	G2
458361	F7	464056	F11	498157	F6	517518	G9	553921	G19
458364	F11	464092	F8	498303	F6	517519	G9	553925	G2
458367	F7	464205	F11	498339	F6	517527	G21	553940	G18
458368	F7	464240	F11	500181	G2	520325	G25	553948	G18
458370	F7	464242	F11	500291	G18	520395	G25	554354	G2
458375	F8	464243	F11	503014	G28	523986	B1	554408	G8
458389	F7	464247	F11	504665	G2	524215	G19	554440	G21
458514	F7	464255	F11	504801	G2	524911	G18	554539	G25
458613	F7	464256	F11	505980	G2	526404	G24	554602	G2
458619	F7	464277	F9	509191	G2	526406	G24	554626	G21
458622	F7	464317	F8	509484	G2	526408	G24	554710	G2
458647	F7	465717	D2	509753/S	G2	526410	G24	554719	G24
458658	F7	465918	D2	509936	G2	526415	G24	554734	G25
458675	F7	465932	F2	516285	G2	526418	G24	554813	G28
458725	F7	465939	F2	516356	G2	526421	G24	554816	G28
458726	F7	465958	F2	516358	G2	526424	G24	554820	G28
458855	F8	466026	F2	516399	G3	526463	G24	554871	G21
458865	F7	466040	F2	516402	G2	526466	G24	554872	G21
458866	F7	466124	A18, D1	516409	G2	526468	G24	554946	G18
458869	F9	466125	A5, D1	516524	G2	526469	G24	555275	G2
458876	F8	466166	F2	516651	G19	526471	G24	555309	G3
458877	F8	466168	A11, D2	516658	G19	526493	G25	555415	G21
459002	F7	466230	A8, D1	516659	G19	526494	G25	555704	G21
459004	F7	466233	A11, D1	516709	G18	526496	G25	555906	G19
459005	F7	468631	F2	516710	G18	526513	G25	555910	G3
459033	F6	468677	A8, D2	516723	G18	526514	G25	555911	G21
459036	F7	468678	A3, D2	516728	G18	526518	G25	556402	G20
459037	F7	468973	A20, D2	516741	G19	526519	G25	562303	G2
459105	F7	468993	F2	516767	G19	526520	G25	562304	G19
459130	F7	469107	F2	516798	G2	526521	G25	562306	G2
459139	F7	469153	F6	516802	G2	526522	G25	572039	A5
459142	F8	469363	F6	516805	G3	526563	G24	572261	G8
459156	F7	469403	F6	516810	G19	526565	G24	572289	G24
459190	F7	469427	A6, D2	516811	G19	526567	G24	572363	G28
459194	F9	470533	F8	516812	G19	526568	G24	573618	G25
459198	F9	470534	F7	516816	G3	526569	G24	573619	G25
459199	F9	470537	F7	516817	G9	526573	G24	573646	G25
459205	F9	470555	F7	516828	G6	534296	G2	573801	G26
459238	F7	470608	F8	516829	G21	534343	G4	573825	G24
459266	F8	470609	F7	516910	G19	534365	G28	573828	G24
459269	F8	470684	F7	516911	G19	534383	G28	573832	G24
459271	F8	470688	F7	516912	G16	534386	G28	573839	G24
459304	F9	470914	F9	516951	G11	534722	G28	573871	G26
459305	F9	470924	F9	516972	G8	534732	G28	574500	G25
459313	F9	484098	F8	516973	G8	534781	G30	574749	G26
459321	F9	490663	F6	516993	G2	534790	G30	575200	G24
459375	F9	490665	F6	517003	G19	534928	G29	575207	G24
459376	F10	490859	F6	517020	G2	535009	G28	575208	G24
460051	F8	490895	F6	517022	G2	535078	G29	575209	G24
460052	F8	491168	F6	517066	G3	535080	G29	575219	G24
460053	F11	491264	F6	517074	G8	535091	G29	575480	G26
460055	F11	491335	F6	517075	G3	535099	G29	575481	G26
460056	F11	491488	F6	517126	G10	535182	G29	575878	G26
460061	F8	492147	F6	517187	G11	535183	G29	575883	G26
460065	F8	492195	F8	517215	G20	535303	G29	575908	G26
460066	F8	492342	F6	517237	G3	535304	G29	575964	G24
460067	F8	492468	F6	517238	G3	535901	G25	575990	G24
460068	F8	492709	F6	517239	G4	535904	G25	576002	G24
462863	F11	492853	F7	517241	G6	550875	G2	655453	G30
463066	F8	492854	F7	517242	G6	551803	G25	656039	G11
463075	F11	492856	F7	517243	G6	551807	G2	656105	G11
463107	F7	492979	F6	517247	G6	552373	G18	656118	G11
463109	F11	493176	F9	517248	G6	552492	G29	656125	G11
463112	F11	493178	F8	517296	G18	552813	G21	656132	G11
463113	F11	493181	F11	517304	G18	552906	G21	700168	E2
463114	F11	493202	F7	517332	G18	552943	G2	700238	E1
463117	F11	493304	F8	517333	G18	553065	G2	700714	E1
463334	F11	493454	F9	517366	G4	553147	G2	700776	E1
463898	F11	493716	F8	517382	G18	553248	G2	701686	E2
463899	F11	493747	F8	517385	G18	553267	G18	701829	E1
463931	F7	493805	F6	517388	G18	553356	G2	701851	E1

NUMERICAL INDEX



Part No.	Page No.	Part No.	Page No.	Part No.	Page No.	Part No.	Page No.	Part No.	Page No.
703004	E1	842020	B5	54052085	G29	54250479	F3	54440610	A18, F6
703106	E1	842021	B5	54052086	G29	54250509	F3	54440631	F6
703185	E2	842022	B5	54052087	G29	54250595	F3	54440632	F6
703233	E1	842023	B5	54052140	G28	54250596	F3	54440869	F9
703235	E1	842024	B5	54052141	G28	54250639	F3	54440887	F8
703339	E1	842025	B5	54052142	G28	54250751	F3	54440888	F7
703349	E2	842026	B5	54052143	G28	54250753	F3	54441000	A4, F6
703396	E2	842027	B5	54057021	G30	54250763	F3	54441256	F6
703988	E1	850641	A18, G30	54057078	G30	54251434	F3	54441257	F6
705068	E1	857141	B6	54068000	A18	54251629	F3	54441424	F6
705085	E1	857144	B6	54068008	E3	54252305	F3	54441582	A20
705086	E1	857158	B5	54068009	E3	54252306	F3	54480662	D2
705098	E1	857159	B5	54068016	E3	54280994	B4	54520003	G21
705108	E1	859060	G20	54068017	E3	54280996	B4	54520009	G11
705114	E1	859260	G2	54068028	E3	54280997	B4	54520057	G29
749981	A19	861900	G30	54068029	E3	54282497	B4	54520077	G29
762229	H2	862217	G2	54068034	A1, E1	54330485	A6	54520104	G21
762250	H2	863123	G3	54068036	A5, E1	54330486	A6	54520142	G29
831200	A20	863125	A5	54068060	E3	54330517	H3	54520144	G29
837351	A2	863511	A17, G25	54068061	E3	54330576	A5	54520145	G29
837541	A8	863745	A4	54094099	A6	54330641	A3	54520146	G29
837771	A6	865001	A16	54100206	G30	54330642	A3	54520195	G29
838231	A3	865129	A12	54100434	F2	54330662	A3	54520204	G18
838291	A8	865130	A12	54100561	G29	54330663	A3	54520246	G12
838321	A20	865136	A2	54101351	G30	54330934	A1	54520300	G13
838341	A15	865206	A11	54101366	G30	54330935	A21	54520317	G18
838361	A4	865225	A1	54101366	G30	54330935	A21	54520317	G18
838481	A8	865225	A1	54101749	F6	54331313	A18, G18	54520340	G12
838551	A7	865236	A11	54120019	F4	54331351	A5	54520342	G13
838601	A21	865258	A6	54148517	G28	54331427	G18	54520343	G13
838621	A4	865493	A6	54160003	F4	54331482	A5	54520352	G28
838671	A1	865494	A7	54190000	B7	54332498	A1	54520354	G13
838681	A8	900269	G3	54190013	B7	54332598	G25	54520392	G17
838971	A13	900288	G3	54190014	B7	54333714	G30	54520397	G17
838981	A12	24159023	B4	54190015	B7	54336176	H4	54520452	G13
839021	A15	24159028	B4	54190038	B7	54336177	H4	54520510	G13
839101	A18, J1	24159040	B4	54190042	B7	54336178	A3, H4	54520575	G13
839102	A18, J1	24159049	B4	54190043	B7	54336190	G30	54520609	G14
839171	A18	24159062	B4	54190044	B7	54336307	A3	54520610	G14
839401	A18	24159077	B4	54190045	A19	54339152	G30	54520654	G29
839421	A18	24179521	B4	54190076	B7	54360213	G25	54520655	G29
839422	A18	24183604	B4	54190096	B7	54380088	C1	54520728	G14
839441	A18	24188697	B4	54190108	B7	54380121	G30	54520774	G15
839770	A7	24188698	B4	54190119	B7	54380161	C1	54520844	G15
839780	A7	24188740	B4	54190119	B7	54380161	C1	54520844	G15
839800	A10	24188740	B4	54199524	B7	54381654	C1	54520852	G15
839810	A11	24188741	B4	54210167	D2	54381655	C1	54520858	G16
839840	A11	24188743	B4	54210167	D2	54381655	C1	54520871	G16
839850	A6	24188743	B4	54210413	A13, D1	54381656	C1	54520871	G16
839870	A8	24188744	B4	54210937	D1	54410078	F2	54520978	G22
841601	B5	24188778	B4	54210940	A5, D1	54410498	F5	54521021	G16
841602	B5	24188779	B4	54210946	A5, D1	54410545	F5	54521353	G16
841610	B6	24188780	B4	54210946	D2	54410823	F4	54521611	G17
841611	B6	24189045	B4	54211509	A20	54410895	F4	54521617	G23
841612	B6	24189317	B4	54211596	D1	54410896	F2	54521737	G23
841613	B6	24189318	B4	54212005	D1	54411249	F4	54521793	G17
841615	B6	24189333	B4	54212288	D1	54411736	F4	54521860	G18
841617	B6	24189334	B4	54212457	D1	54411737	F4	54521888	G18
841662	B6	24189336	B4	54212537	D1	54412018	F4	54521888	G18
841670	B6	24189603	B3	54213900	D1	54412359	F5	54570241	G26
841672	B6	54025006	A19, F3	54213901	A6, D1	54412359	F5	54570242	G26
841687	B6	54033003	A3, H4	54213902	D1	54412407	F4	54570349	G25
841690	B6	54033004	A3, H3	54213903	A3, D1	54412727	F4	54570388	G24
841698	B6	54033004	A3, H3	54213904	D1	54412731	F4	54570739	G25
841919	B6	54033018	A18, H3	54213904	D1	54412732	F5	54570783	G24
842010	B5	54033027	A1, H4	54213905	D1	54413002	F2	54571021	G24
842011	B5	54033027	A1, H4	54213906	D1	54413002	F2	54571021	G24
842012	B5	54033028	A2, H3	54213907	D2	54413020	F2	54571053	G24
842013	B5	54033056	A2, H4	54214031	A5, D1	54413522	F2	54571096	G26
842014	B5	54033109	A1, H3	54214272	A20	54414381	F5	54571232	G24
842015	B5	54033109	A1, H3	54250141	F3	54414514	F2	54571232	G24
842016	B5	54033234	A3, H3	54250141	F3	54440026	F6	54571319	G24
842017	B5	54033235	A3, H3	54250241	F8	54440029	F2	54571577	G30
842018	B5	54033240	J1	54250271	F3	54440031	F2	54571677	G24
842019	B5	54052019	A18, G23	54250275	F3	54440032	F2	54572021	G30
		54052080	G28	54250289	F3	54440032	F2	54572144	G30
		54052081	G28	54250291	F3	54440090	F8	54572215	G30
		54052082	G28	54250294	F3	54440096	F8	54572217	G30
		54052083	G28	54250347	F3	54440136	A19	54572219	G30
		54052084	G28	54250355	F3	54440357	F6	54572534	G30
				54250427	F3	54440529	F6	54572535	G30



NUMERICAL INDEX

Part No.	Page No.	Part No.	Page No.	Part No.	Page No.	Part No.	Page No.	Part No.	Page No.
54572932	G24	54930094	A10	54941158	B6	54943613	A17	54946920	A3
54572950	G24	54930095	A8	54941159	B6	54943628	A17	54947217	A3
54680620	E3	54930203	A16	54941160	B6	54943631	A17	54947272	A19
54680686	E3	54930207	A16	54941161	B6	54943687	A17	54947622	A10
54680727	E2	54931110	E3	54941180	B6	54943884	A19	54947955	A20
54680729	E2	54931221	A21	54941181	B6	54944147	A2	54947957	A17
54680731	E2	54931222	A20	54941182	B6	54944148	A1	54948006	A7
54680732	E2	54931230	A19	54941183	B6	54944333	A17	54948007	A7
54680850	E2	54931326	A14	54941184	B6	54944350	A2	54948030	A20
54680900	E3	54931371	A7	54941185	B6	54944387	G15	54948258	A20
54680901	E3	54931590	A21	54941186	B6	54944898	B7	54948259	A21
54680902	E3	54940037	G3	54941657	A5, J1	54944902	A17	54948927	A20
54680903	E3	54940078	A13	54941756	A2	54944995	A21	54949610	A5
54680993	E3	54940190	A17	54941768	G11	54945033	A21	54949612	A3
54680994	E3	54940310	A13	54941907	A1	54945036	A21	54949615	A3
54681085	E2	54940461	A16	54942037	A2	54945038	A20	54949736	A7
54681247	E2	54940666	A5	54942078	B7	54945043	A21, G25	54949773	A7
54681248	E2	54940814	A8	54942079	B7	54945334	A2	54949910	A2
54681363	E3	54940852	A16	54942360	A12	54945365	A2	54949911	A2
54681364	E3	54940984	A3	54942678	A18	54945366	A3	54949912	A2
54850133	A21	54941002	A3	54942747	B7	54945941	A17	54949913	A1
54930007	H3	54941154	B6	54943000	A21	54945943	A17	54949914	A2
54930008	H4	54941155	B6	54943001	A20	54946012	G15	54949915	A1
54930013	B5	54941156	B6	54943002	A21	54946189	A7	54949931	A6
54930058	A8	54941157	B6	54943527	A7	54946452	A21	54949940	A16
								54949954	A21