

ASSOCIATED MOTOR CYCLES LTD. PLUMSTEAD ROAD, LONDON, S.E.18

Reprinted from the "Machine-Tool Review", the technical journal published by Alfred Herbert Ltd., Coventry

THIS Company, as the name implies, is an association of five well-known motor cycle manufacturers—Matchless, A.J.S., Norton, Francis Barnett and James. The parent company made the Matchless products—cycles in 1878, the first motor cycle in 1900. In 1931 the Matchless Company acquired the A.J.S. concern, and within a few years the company changed its name to our title which, in recent years, embraced the activities of the three other companies.

The aim of the Associated Company is to produce a range of motor cycles in quantities and at highly competitive prices mainly for the overseas markets; they have been very successful. This joint effort, required for economical reasons, has a centralised production shop at Plumstead in London to augment the individual assembly, sales and service facilities which are still retained at the existing premises of each concern. Matchless and A.J.S. at Plumstead, Norton and James at Birmingham and Francis Barnett at Coventry.

The design and erection of each of the makes of motor cycles has been retained by the respective firms. Standardisation has, however, been adopted as much as possible. A gearbox and a 2½ h.p. 4-stroke engine, for instance, are common to most makers' products. A 2-stroke engine is used for certain models of the James and Francis Barnett range of machines.

Thus we have some of Britain's leading experts in the motor cycle world associated to produce—as is being accomplished—the world's finest and most reliable range of motor cycles.

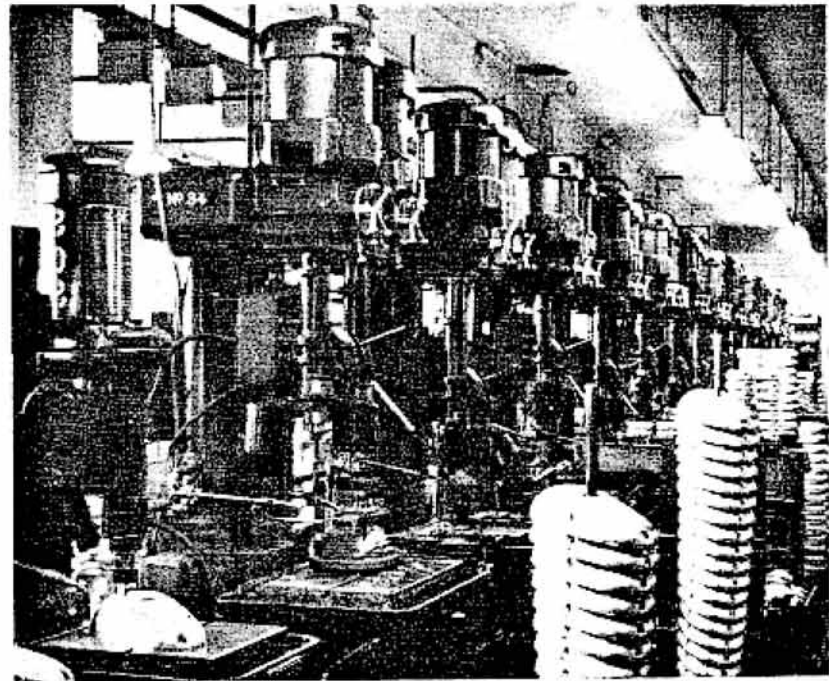

Fig. 1. Some of the 230 Herbert Drilling Machine Spindles in the Plumstead Works of the Associated Motor Cycles Ltd.

The Association has also permitted large capital expenditure both on the extension of the buildings and in the re-equipping of the machine shops at Plumstead. It is estimated that nearly a million pounds has been spent on the project. New equipment required the expenditure of hundreds of thousands of pounds.

This expenditure was necessary to increase production of a 4-stroke engine, to design and manufacture a 2-stroke engine and a new type gearbox for both

types of machine. Prior to the association of the companies, the 2-stroke engines and gearboxes were purchased from other companies.

The Herbert Organisation was virtually appointed as consultants for the whole production project and worked in close co-operation with the production engineers of the Association. The capital expenditure involved was for complete plant and equipment for the production of some 400 engines and 650 gearboxes per week.

During the last five years we have supplied to this Company nearly five hundred machines including 150 Herbert Capstan Lathes, from the smallest to the largest, some 230 Herbert Drilling Machine Spindles and Herbert Auto-Lathes, Milling Machines and Flash Tappers. The Factored Division has supplied several batteries of Archdale Vertical and Horizontal Milling Machines of various capacities, and Brown & Ward Single-spindle Bar Automatics. Other machines included the Cri-Dan High-speed Threading Machine, Archdale Vertical Drilling and Boring Machines, and every conceivable type of machine tool expected to be seen in highly productive and efficient machine shops. The jigs, fixtures and tooling to give the necessary efficiency of production were also supplied.

The accompanying illustrations give a brief indication of the extent of the installation of Herbert-manufactured machine tools.

Apart from the Autos mentioned and twenty other Single- and Multi-spindle Bar Automatics, the whole plant is equipped

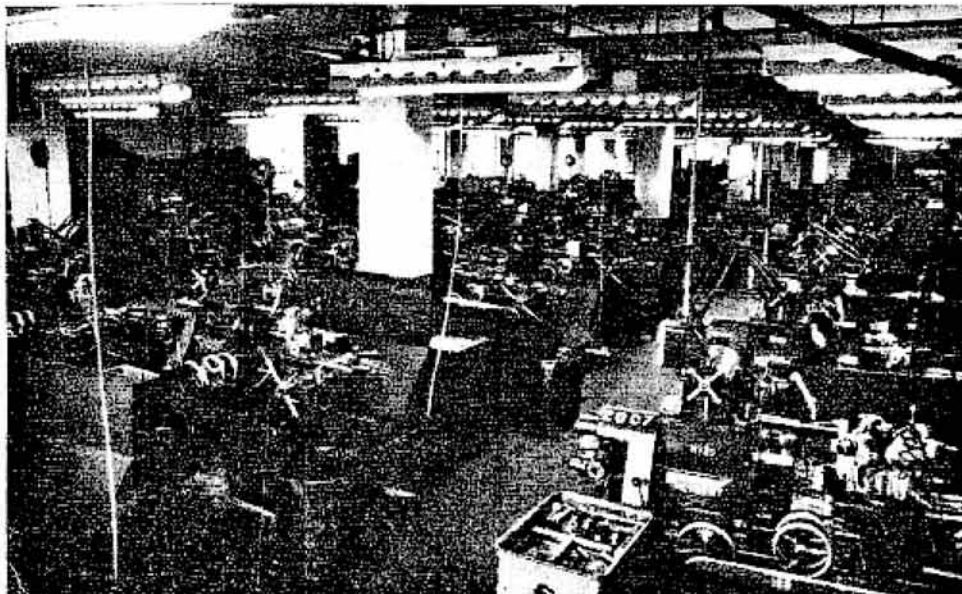

Fig. 2. One section of the lathe department which has 29 Herbert No. 2D Capstan Lathes primarily equipped for chuck work up to 9" swing and adequately tooled to perform the maximum number of operations possible in one set-up.

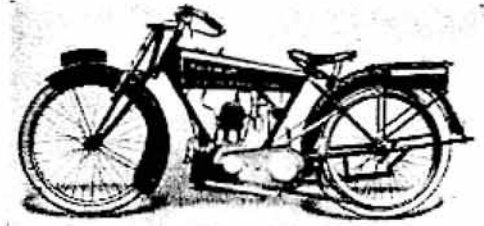

Fig. 3. Early models. (Left) The pioneers with the first A.J.S. machine. (Centre) A 1902 Matchless on the London to Brighton run. (Right) Francis Barnett 1920 "Fanny B".

with the general-purpose type of machines, installed for flow production methods. Handling is reduced to the minimum by grouping different types of machines for the production of a component and its mating parts (see Fig. 9). Machines are also grouped and tooled to produce parts of similar design: thus, tool-setting, storing and servicing are simplified (see Fig. 22).

It is, however, in the drilling and lathe departments that reductions in production costs have been most marked. Modern machines and efficient tooling permit the adoption of the high production techniques made possible by the design features of both machines and tools. Productivity is mainly dependent on the efficiency of the tooling arrangement—the machine provides the power, rigidity and facilities to use the tooling designed for rapid metal removal consistent with concentricity and good surface finish in the work.

The adaptability of the Herbert Capstan Lathes for techniques requiring rapid production of batches up to medium quantities is well-known. They are designed to ensure maximum efficiency with such methods, although they have proved equally economical on very small batches, six to twelve off, and for continuous production techniques. Herbert Lathes are the simplest to operate and set-up, and have the power, rigidity, alignments and wide ranges of speeds and feeds to meet the varying conditions involved in the machining of materials ranging from light alloys to stainless steels, from heavy roughing to light precision finishing opera-

tions. They can be equipped to minimise the number of operations necessary to machine completely a specific component.

Even though drilling and its associated operations are of a straightforward nature and may not appear to offer much opportunity for reducing machining costs, the results obtained by using new machines and equipment is surprising. This is exemplified in the drilling department at Plumstead. Attention is drawn to:—

- (a) the "milling operation" shown in Fig. 25.
- (b) the drill depth indicators of Herbert and of A.M.C. design fitted to practically all the Herbert Drilling Machines.
- (c) the extensive use of the Herbert Quick-change Drill Chuck which virtually converts a single-spindle into a multi-column machine (see Figs. 9 and 19). The drill, the countersinking or radiusing tool, the reamer, the spotfacing tool, can all be interchanged without stopping the spindle and with perfect safety. No spanner, key or tightening is necessary. The chuck can be integral with the spindle where it is desirable to reduce overhang.
- (d) Multi-spindle machines with simple sliding locating fixture (see Figs. 16 and 24).
- (e) work locating jigs providing several approaches to the component (see Fig. 19).
- (f) Automatic reversing tapping attachments. On a type C machine up to

15 holes can be tapped per minute. It is suitable for right- or left-hand tapping and does not interfere with normal drilling. A small diehead can also be fitted for cutting external threads. If a higher tapping rate is required, the Herbert Flash Tapper, which can be reversed up to 30 times per minute, is used.

- (g) Automatic spindle feeds, trips and return traverse, which enable the operator to unload and load on one spindle whilst drilling takes place on another. The pre-selection of a controlled constant feed rate also assists in ensuring long tool life.
- (h) The finger-tip control of instantaneous starting, stopping and reversing of the spindle, have also reduced idle time to the minimum. Speed and feed selection is also very simple. These features are necessary to maintain the higher productivity obtained by using the Quick-change Drill Chuck.

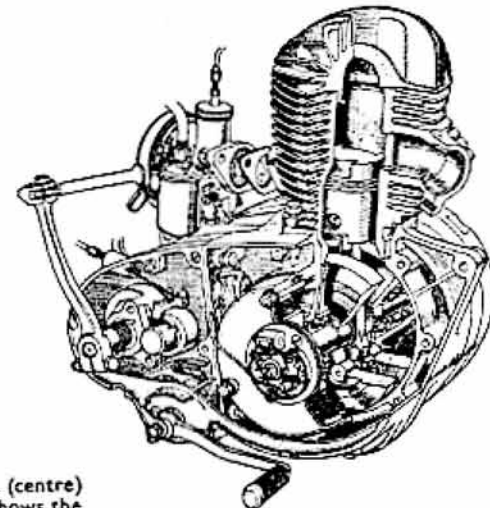
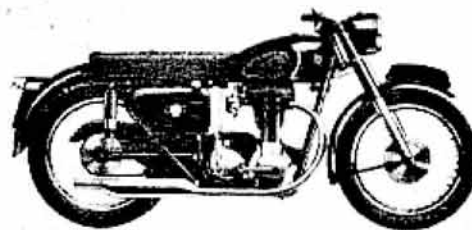
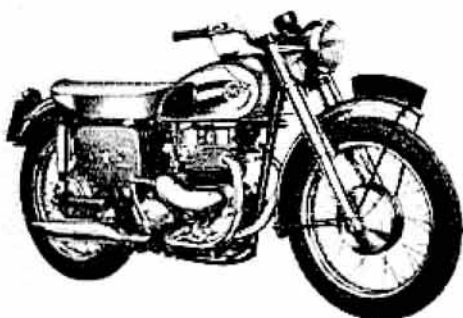

Fig. 4. The 1958 models of the Matchless (left), A.J.S. (centre) and Francis Barnett (right). The sectional drawing shows the compact power unit now built in large quantities in the Plumstead Works of the Associated Motor Cycles Ltd.

Fig. 5. Another section of the Lathe department showing some of the 35 Herbert No. 4 Senior Capstan Lathes installed. The small illustration below shows the latest type Herbert No. 4 Senior Preoptive Capstan Lathe machining wheel hubs in the Norton Works at Birmingham.

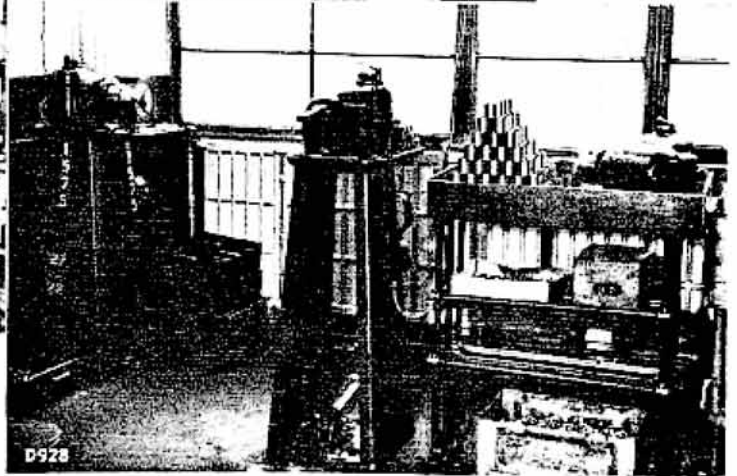

Fig. 6. Three photographs taken in the Plumstead Works showing :—

D930. A battery of Archdale Vertical Milling Machines and, at the far end, Herbert Drilling Machines.

D929. A row of Herbert No. 4 Senior Capstan Lathes set up for machining various aluminium cases. Some of the set-ups are shown in Figs. 7, 8 and 24.

D928. Two column- and one bench-mounted Herbert Utility Heads in the Plumstead Works. These heads are extensively used in the fitting shops and assembly lines of many firms. Excellent time-saving devices they enable small components to be polished, reduced in diameter or length, or burrs to be removed without having to return them to the machine shop. They are fitted with a 3-jaw chuck.

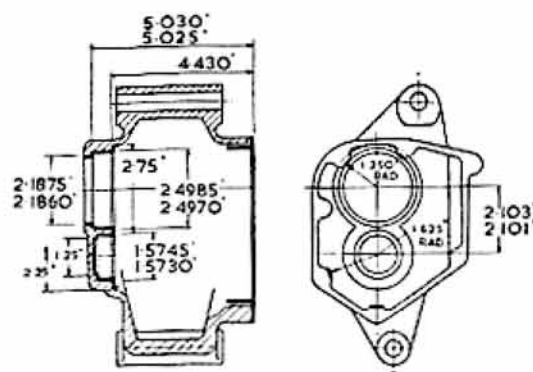
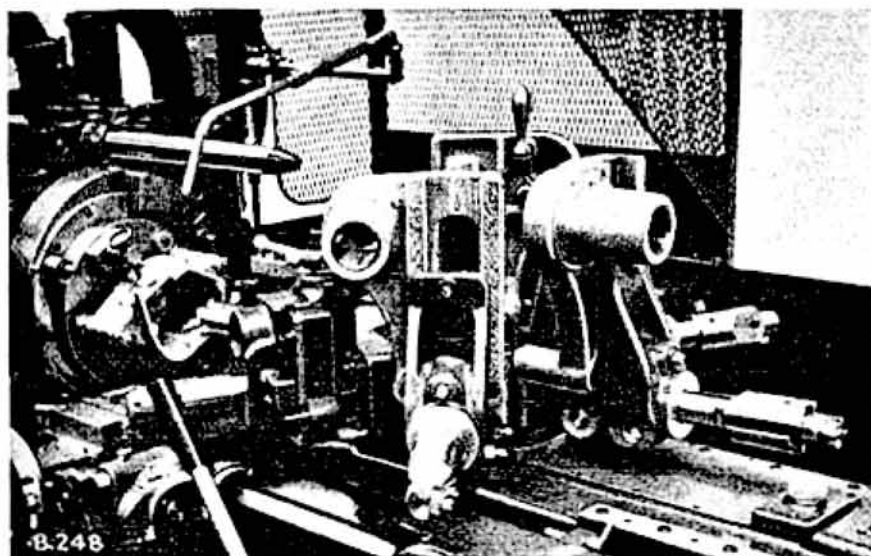

Fig. 7. Machining gearbox shells on a Herbert No. 4 Senior Capstan Lathe. Made from aluminium diecastings, the shells have previously been straddle-milled on the lugs and drilled.

The lathe has no square turret on the cross slide and a 2-position indexing work-holding fixture is bolted directly to the spindle flange. Location is taken from the drilled holes and lugs.

The sequence of operations is as follows:—

- Face end with Ardoloy tool on rear toolpost of cross slide.
- Simultaneously rough bore 2.1875" and 2.4985" diameters and 1.250" radius.
- Simultaneously face the 2.4985" and 2.75" diameters.
- Size-bore 2.1875" and 2.4985" diameters using Microbore Tools.
- Index fixture.
- Simultaneously bore the 1.25" diameter, form the bottom face and flat face the 2.25" diameter.
- Simultaneously rough bore the 1.5745" diameter, remove sharp edge and bore the 1.625" radius.
- Size-bore the 1.5745" diameter using a Microbore Tool.

A single speed of 621 r.p.m. and hand and automatic feeds of 180 (rough bore) and 240 (size bore) cuts per inch are used. Automatic feed of 180 cuts per inch is also applied to the cross slide in machining the end face.

The floor-to-floor time, 6 minutes.

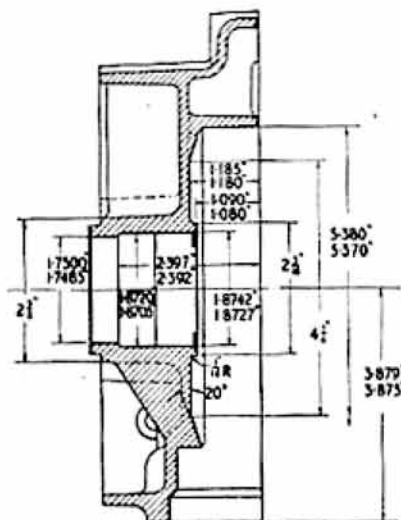
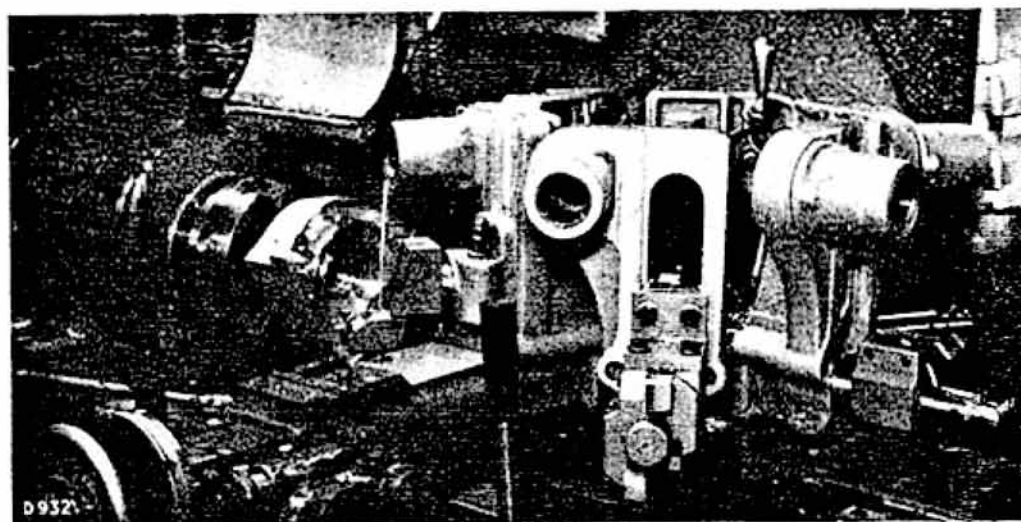

Fig. 8. Machining the flywheel and bearing housings in the timing side of the crankcase on a Herbert No. 4 Senior Capstan Lathe. A full complement of tools is held on the turret, all held in substantial tool blocks in knee turning tool holders to ensure maximum rigidity, sustained by the machine and overhead support steady, for cutting with multi-tooling. The crankcase is gripped on the 2½" diameter boss in a Herbert air-operated chuck. Tooling on the first turret face faces the 2½" diameter boss, rough bores the flywheel housing (5.380 5.370" diameter), forms the 20° angle and faces to the 2½" diameter boss. From the second turret face tooling rough bores the 1.7500" and 1.8720" diameters and chamfers the mouth of the flywheel housing. Simultaneous with this operation, tools in the rear toolpost on the cross slide rough and finish machine the joint face. Microbore tools on the third turret face size bore the 1.7500, 1.7485" diameter and chamfer the 1.8742 1.8727" diameter. Microbore tools are also used to size the 1.8720, 1.8705" and 1.8742, 1.8727" diameters from the fourth and sixth face of the turret respectively. The operation is completed by size boring the flywheel housing to 5.380 5.370" diameter, again using the Microbore unit.

The floor-to-floor time is 8 minutes.

All tooling, including the Microbore units, are tipped with Ardoloy which ensures good surface finish and long life between regrinds.

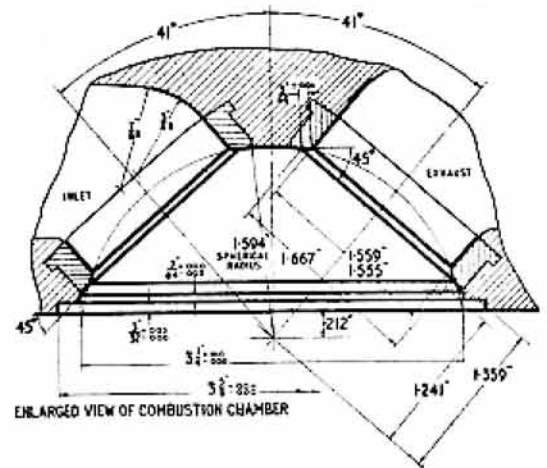
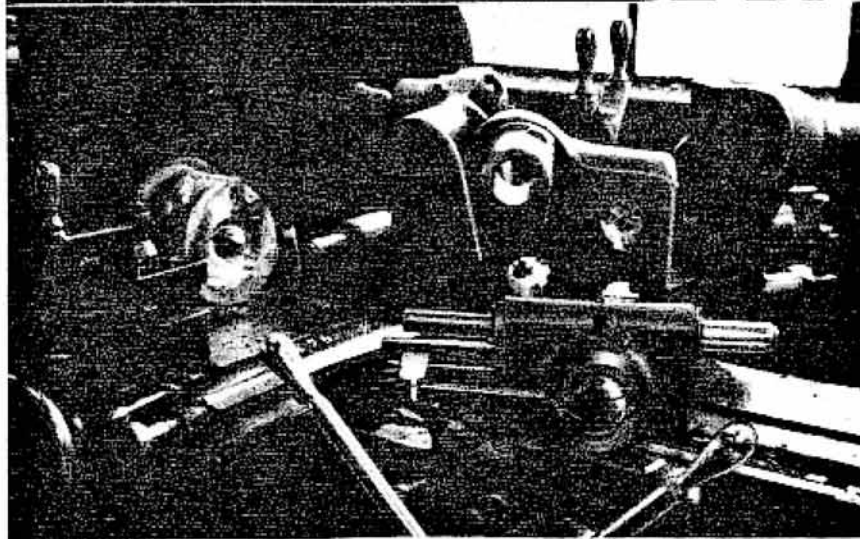
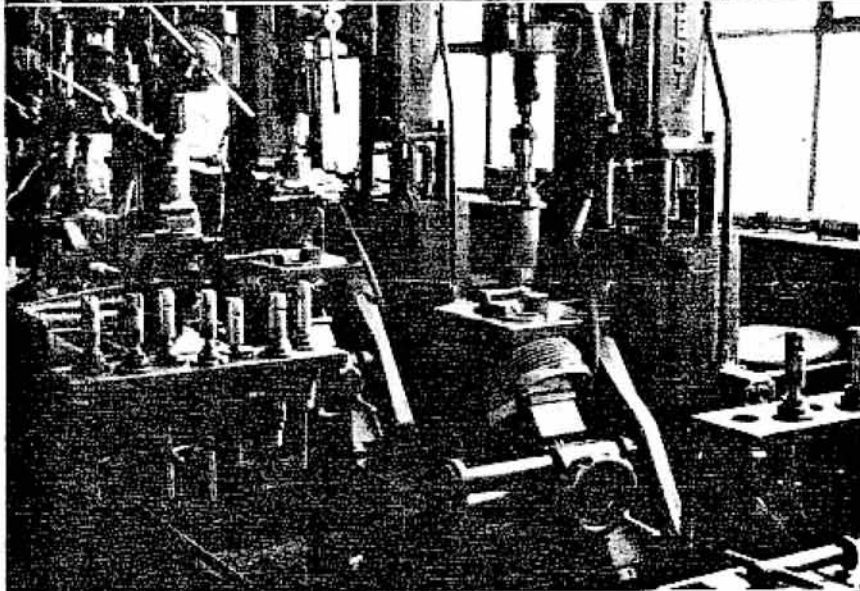
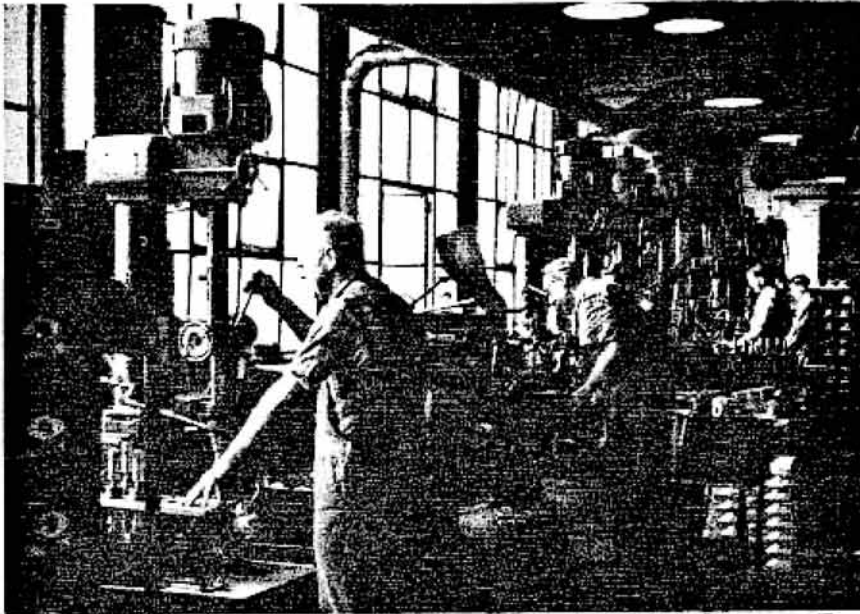

Fig. 9. Eleven Herbert Drilling Machines and a Herbert No. 4 Capstan Lathe are grouped to provide line-production machining of cylinder heads. The sequence of operations is as follows :

2. Mill the valve head joint face.
3. Skim cylinder joint face.
4. Drill 18 holes, from $\frac{3}{16}$ " to $\frac{1}{8}$ " diameter, tap 4 holes, ream 2 holes and counterbore 1 hole.
5. (See bottom illustration). Machine the joint face, rough and finish machine the internal spherical dome (1.594 radius), bore the piston clearance and form the 45° chamfer. Special profiling attachments are used on a Herbert No. 4 Capstan Lathe for rough and finish machining the internal spherical dome. The cutting tool is mounted in pivoting jaws actuated by a pusher in the square toolpost on the cross slide which is automatically fed transversely. Spring action reverses the movement of the cutter when the turret is withdrawn and the cross slide movement reversed.
6. Finish drill two $\frac{1}{8}$ " dia. bolt holes.
7. (See centre illustration). Form the valve guide relief in the inlet port, drill four $\frac{1}{8}$ " dia. holes, form taper in the inlet valve throat, form radius in the inlet valve throat, form the exhaust valve throat, bore the valve guide holes, ream the valve guide holes, and form the valve seats. A simple work locating indexing fixture and Herbert Quick-change Drill Chuck for rapid changing of the different tools, reduce idle time. Some of the tools have extensions for piloting in a support bush in the work-holding fixture. All tools are supported at the approach end.
8. Tap nine $\frac{9}{16}$ " 22 t.p.i. $\times \frac{1}{2}$ " long holes and counterbore tappet-tube recess.
9. Finish tap nine $\frac{9}{16}$ " 22 t.p.i. holes.
10. Face the valve guide holes.
11. Drill the valve-spring seat locating holes.
12. Drill a $\frac{1}{2}$ " dia. $\times 4\frac{1}{8}$ " long oil hole through to inlet valve guide hole, open out this hole with No. 3 drill to depth of $\frac{3}{4}$ ", spot face, counterbore and tap $\frac{1}{4}$ " 26 t.p.i. to depth of $\frac{1}{2}$ ".
13. Drill the exhaust valve guide oil hole.
14. Mill the carburettor flange.
15. Drill and bore the $1\frac{1}{8}$ " guide bush.
16. Open out the inlet port to $1\frac{3}{16}$ " dia. and drill, tap and counterbore two $\frac{3}{16}$ " B.S.F. holes in the carburettor flange.
17. Drill, spot-face, counterbore and tap the sparking plug hole.
18. Bore and spot-face the exhaust port outlet.

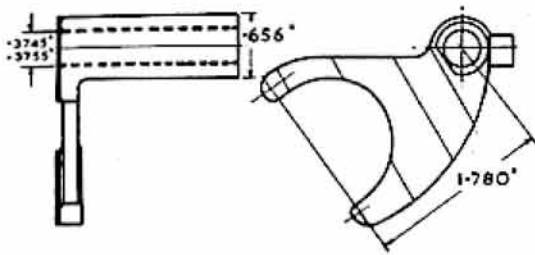

Fig. 10. Machining a selector fork from a steel stamping on a Herbert No. 2D Capstan Lathe fitted with a Herbert 6" 3-jaw chuck provided with a work support block and two balance weights. The chuck sector-plate screw holes are used for securing purposes. The component is gripped on the .656" diameter, the stem locating endwise against the face of a jaw and the prongs of the fork locating on spring-loaded pins held in the support block. The drive to the work is provided by the chuck jaw contacting the boss on the stem.

The operation commences with centring the stem and drilling a .375" hole from the solid. The face of the fork is then machined and the .3745/.3755" diameter is finish machined and size reamed.

Two spindle speeds are used—455 r.p.m. for all operations except reaming, which is done at a speed of 175 r.p.m. Hand feeds for centring and drilling and automatic feeds of 160 (facing) and 80 (reaming) cuts per inch are used.

Floor-to-floor time, 3½ minutes.

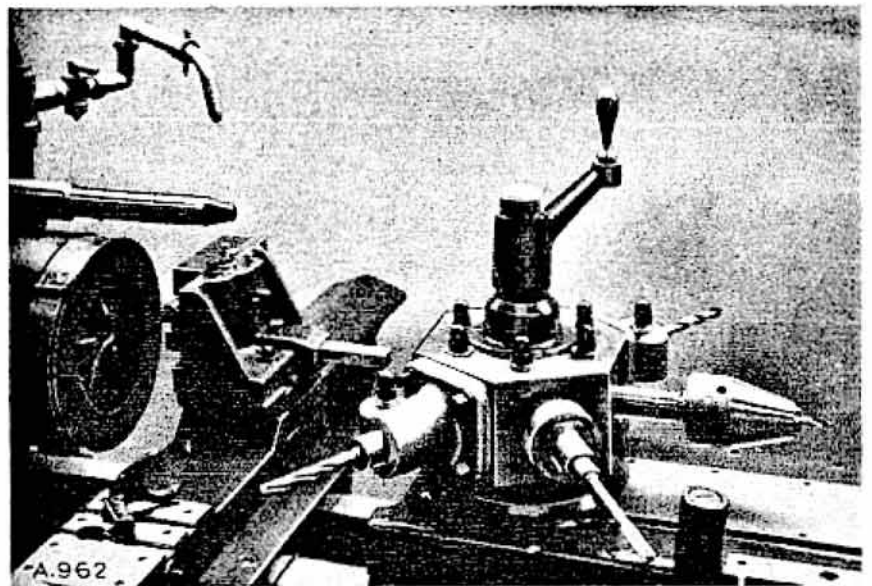

Fig. 11. (Centre illustration). Machining the cast-iron cylinder barrel on a Herbert No. 4 Capstan Lathe. The cast spigot on the cylinder head joint face of the barrel is gripped in a Coventry 3-jaw Chuck. The operation includes rough boring the cylinder barrel to a depth of 3¼", rough and finish turning the 2½" and 3¼" diameters and, whilst supporting the barrel with a revolving steady, rough and finish machine the face of the bore, relief and chamfer the mouth of the bore.

The tools for finish machining the 50° chamfer, the cylinder bore and finishing the 2½" and 3¼" diameters are held in boring bars provided with a pilot which is supported in a steady bush inserted in the chuck bore and with a revolving steady which supports the barrel.

The cylinder barrel is subsequently finish bored to $2.598 \pm .0005$ " dia. \times 5" long.

The floor-to-floor time is 8.5 minutes.

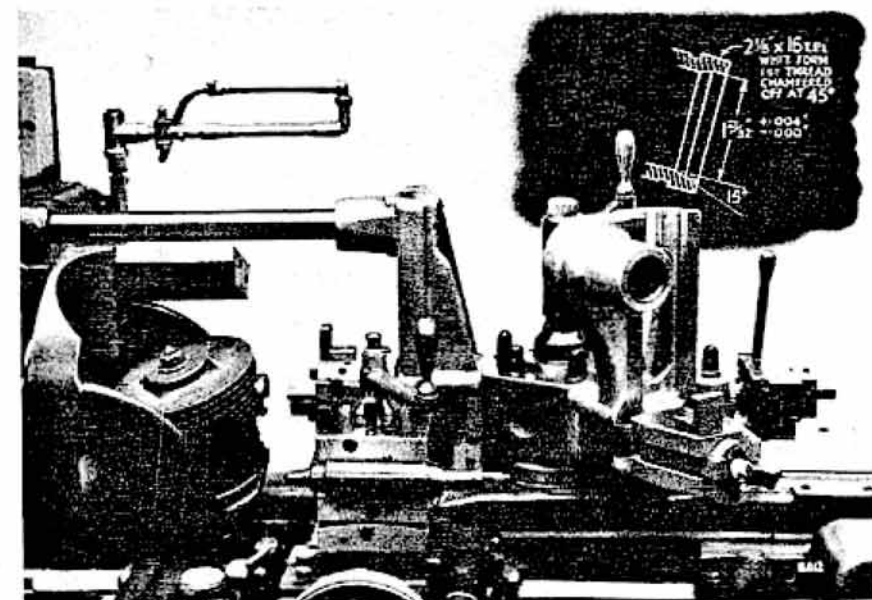
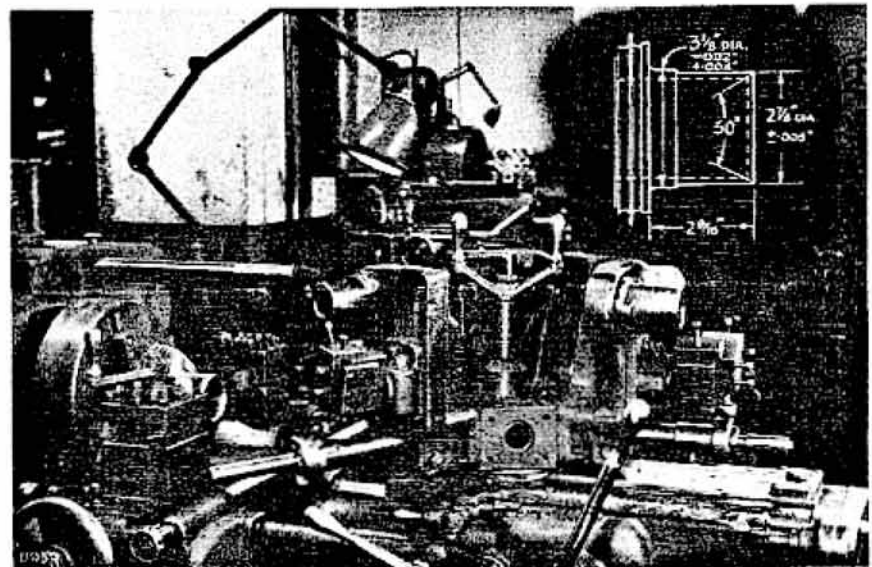

Fig. 12. On a Herbert No. 4 Capstan Lathe two sets of cluster tooling mounted in knee turning tool-holders, rough and finish machine the external and internal diameters, and the face of the exhaust port. A recessing tool slide on the turret is used to form a $2" \pm .005$ " dia. \times ¼" recess behind the 2½" threaded diameter. The 2½" \times 16 t.p.i. thread is chased from the square turret using the Barson rapid chasing attachment which permits internal or external threading up to a shoulder at high rates of production. The movement of the tool is automatically arrested from the turret and is not dependent on the vigilance of the operator, thus high speeds can be used. The telescopic connection between the chasing holder and turret is removed after the chasing operation.

Floor-to-floor time, 9 minutes.

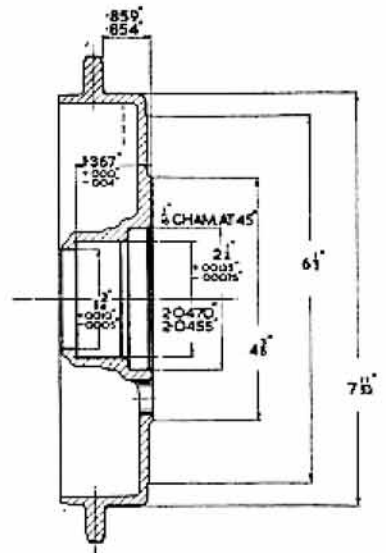
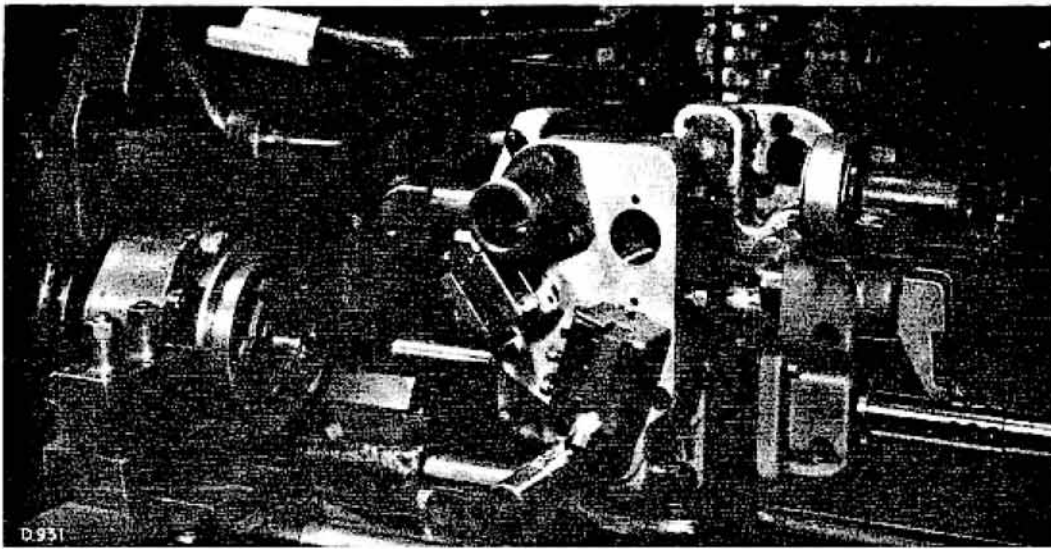

Fig. 13. Wherever conditions are favourable, Herbert Auto-Lathes are installed in the Plumstead Works to provide the greatest output per foot of floor space at lowest labour cost per piece. A row of No. 3A's is shown below. Machining a rear brake drum from a malleable-iron casting on a Herbert No. 3A Auto Lathe is shown above.

Each face of the turret is fitted with a combination tool-holder for holding a piloted boring bar and toolholders for : (1st turret face) rough turn the outside and $7\frac{1}{2}$ " diameters, rough face the boss and rough bore the $1\frac{3}{4}$ " diameter ; (2nd turret face) finish turn the $7\frac{1}{2}$ " diameter and rough bore the 2.047" and $2\frac{1}{4}$ " diameters (during this operation the side faces of the tooth blank and $6\frac{1}{2}$ " diameter clearance are machined from the rear cross slide) ; (3rd turret face) finish turn outside diameter, finish face the boss and finish bore the $1\frac{3}{4}$ " and $2\frac{1}{4}$ " diameters. Simultaneously with forming the radii on the tooth blank from the front cross slide (4th turret face). Finish bore and chamfer the 2.0470, 2.0455" diameter and chamfer the $2\frac{1}{4}$ " diameter.

Floor-to-floor time, 9 minutes.

Fig. 14. Cluster tooling on three of the turret faces and a facing tool on both the front and rear cross slides on a Herbert No. 4 Auto-Lathe, machine the timing side of the aluminium-alloy diecasting crankcase, as indicated by the heavy lines on the drawing. Rough, semi-finish and finish cuts on the $1\frac{1}{2}$ " and 2.998-2.997" bores, rough and finish cuts on the joint face and $8\frac{1}{2}$ " diameter are taken. Tooling on the turret also removes all sharp corners, machines the $2\frac{5}{8}$ " diameter recess and faces the $3\frac{3}{4}$ " diameter. The boring bars are piloted by a steady bush in the work-holding fixture bore.

Floor-to-floor time, 7 minutes.

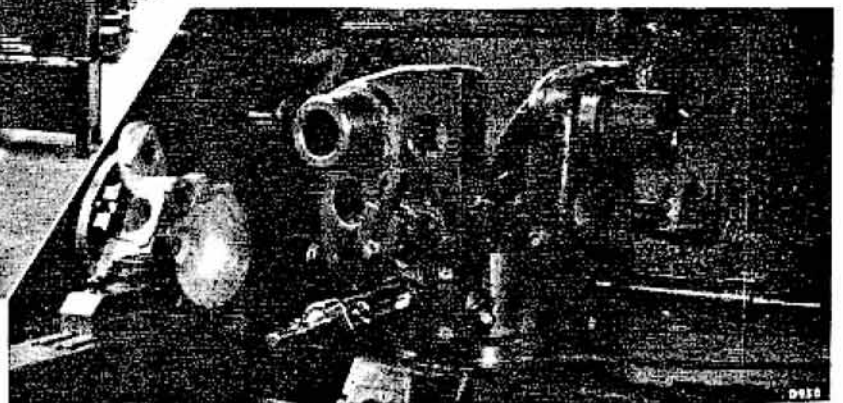
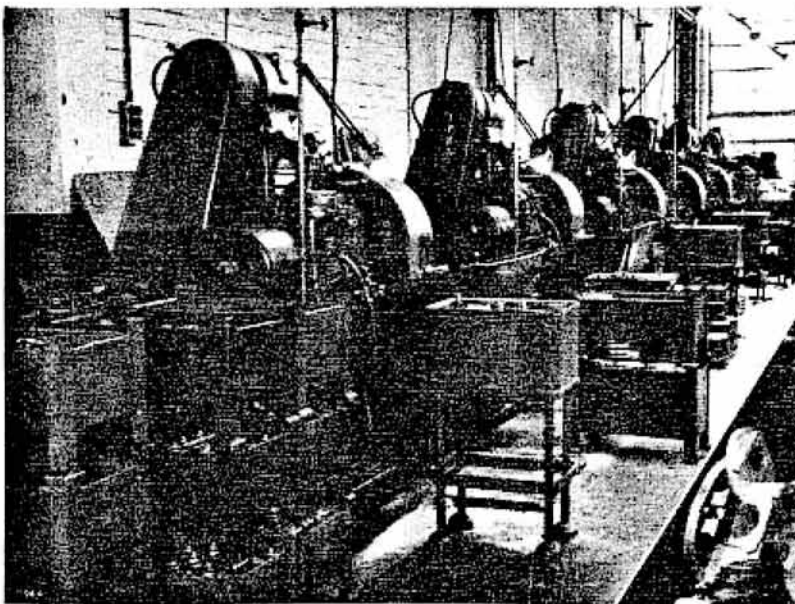
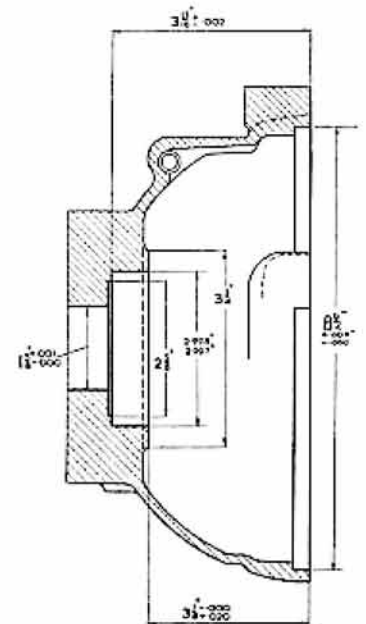

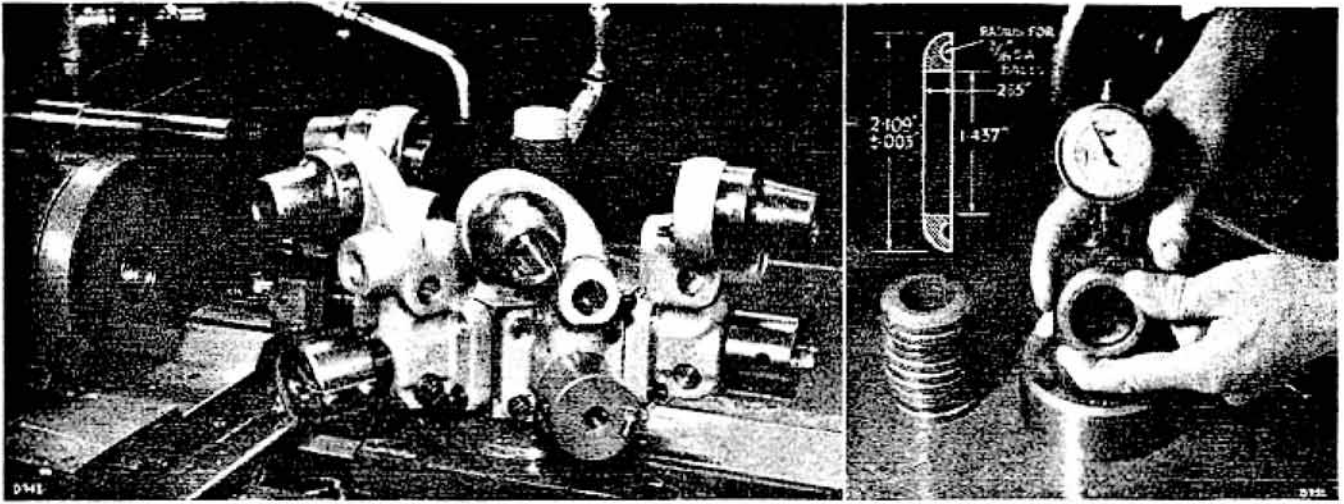

Fig. 15 (above). Precision machining the ball radii in top and bottom races on a Herbert No. 2D Capstan Lathe. The operation includes facing to remove the parting-off burr and rough, semi- and finish-machining the radius. The operator inspects the pitch diameter with the dial gauge shown.

The cutting tools are clamped in substantial holders, held on knee turning tool-holders on the turret provided with overhead support steadies. The tool-holders are of the light-metal type to reduce weight on the turret indexing mechanism and operational fatigue on operations of short duration but requiring continual turret indexing.

The floor-to-floor time for the operation is 1.1 minutes.

The gauge has three locating balls, two are fixed and the other is spring-loaded against an anvil contacting the moving plunger of the dial indicator. Rotating the race in contact with the locating balls indicates any error in pitch diameter.

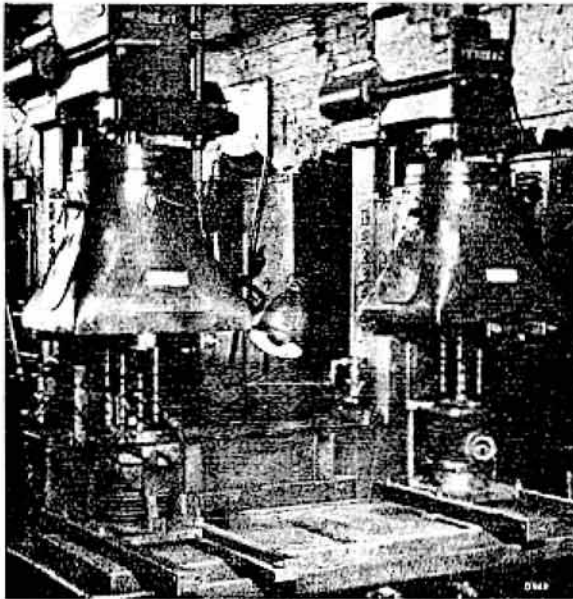

Fig. 16. Two top columns of Herbert Type M Multi-spindle Drilling Machines mounted on a four-spindle base for drilling and countersinking four $\frac{7}{16}$ " diameter holes in the cylinder barrel flange and four $\frac{1}{8}$ " B.S.F. tapped holes, 1.063-1.031" deep, in the cylinder head joint face. The quick-acting, sliding fixtures are located against a back stop.

Floor-to-floor time, 2 minutes.



Fig. 17. In the foreground of the top illustration are two of a forest of Herbert Single-spindle Drilling Machines equipped for two operations on a motor cycle handle-bar lug. Holes up to $1\frac{1}{2}$ " diameter are drilled from the solid, counterbored, spot-faced and reamed. Simple indexing fixtures speed up machining. The wide ranges of speeds and feeds available are of great value in these operations.

In the lower illustration, a Herbert Type C Drilling Machine is efficiently used for performing fifteen different operations—drilling, reaming, tapping, spot-facing and counterboring—on an aluminium outer cover. The Quick-change Drill Chuck has proved a great time saver and the ease of speed and feed changing has reduced operational fatigue in an operation which is performed in 13 minutes.

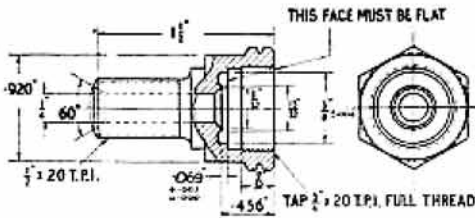

Fig. 18. Efficient, rigid tooling on a Herbert No. 2D Capstan Lathe performing the second operation on a shock absorber bolt produced from a nickel-chrome molybdenum hexagon bar, .920" across flats. The operation includes gripping on the .920" diameter in a Herbert air-operated 3-jaw chuck, centring, drilling and forming countersink, bottoming with flat drill, forming the $\frac{3}{8}$ " diameter recess, boring the thread diameter, facing to ensure .069" length, capping the $\frac{3}{8}$ " x 20 t.p.i. thread and finish bore the thread diameter.

Floor-to-floor time, 2 minutes.

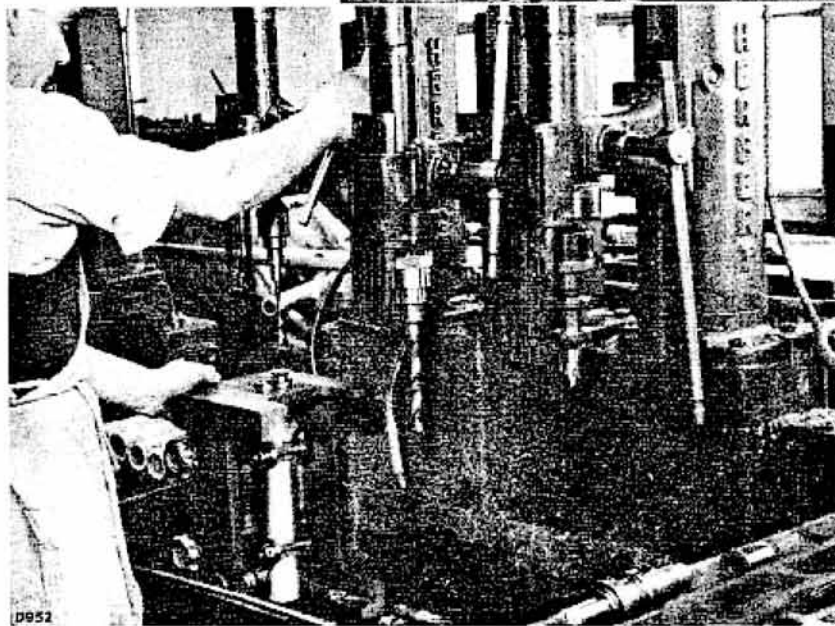
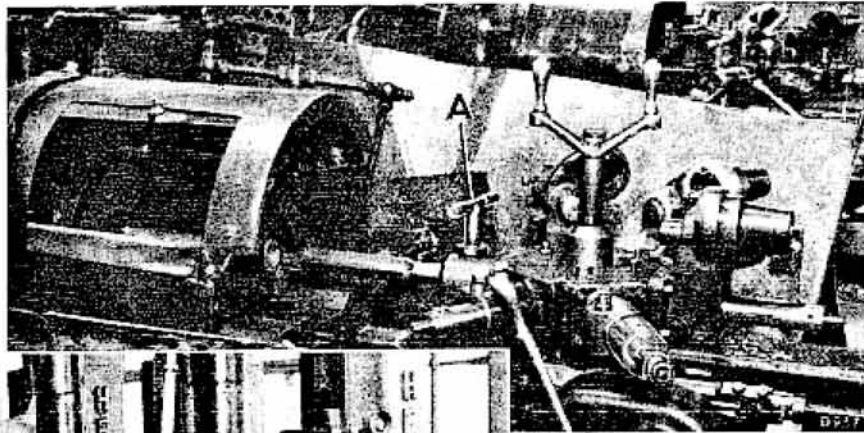
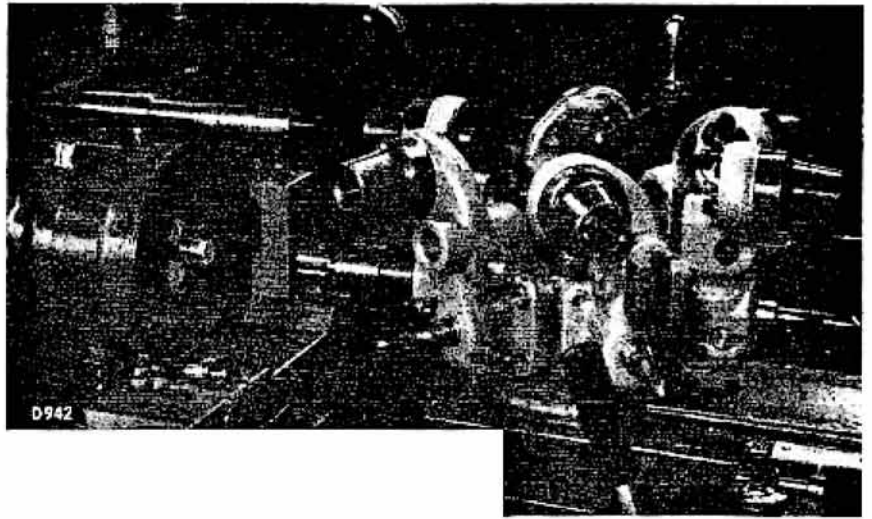
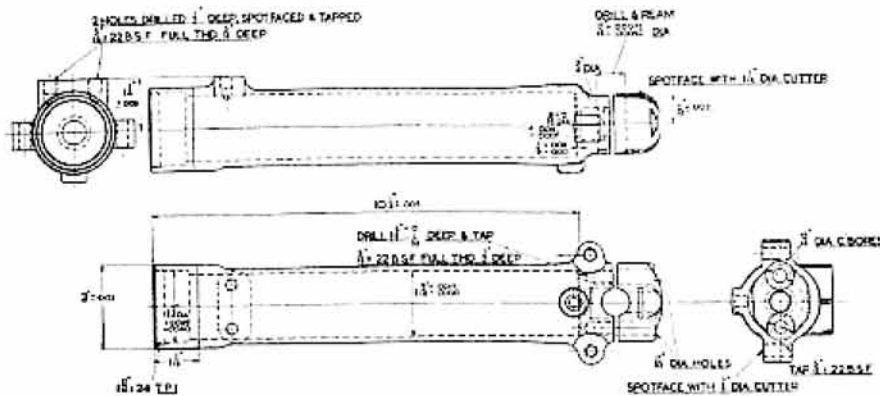

Fig. 19. The two principal operations on the front fork slider machined from an alloy diecasting. The set-up on the Herbert No. 4 Capstan turns the 2" diameter to a length of $1\frac{1}{16}$ ", machines the front face, bores the $1\frac{1}{8}$ " and the long $1\frac{1}{16}$ " diameters and taps the $1\frac{1}{8}$ " x 24 t.p.i. thread.

Rough and finishing cuts are taken on the $1\frac{1}{8}$ " diameter using piloted cutters, and three cuts—rough and finish boring and reaming—on the $1\frac{1}{16}$ " diameter. The tools for the latter operation are interchanged after successive cuts, thus enabling the operation to be completed in one set-up. The handle A assists in rapid clamping of the boring bars and the reamer.

The floor-to-floor time is 11 minutes.

The drawing shows some of the holes drilled, spot-faced, countersunk, tapped and/or reamed, whilst the slider is held in a simple turnover fixture, on a Herbert three-spindle Drilling Machine. Cutting tools are changed on two spindles, taking advantage of the quick-change chuck. Drill and other tool guides are inserted in four faces of the work holding fixture. The operation, including loading and unloading, takes 6 minutes.



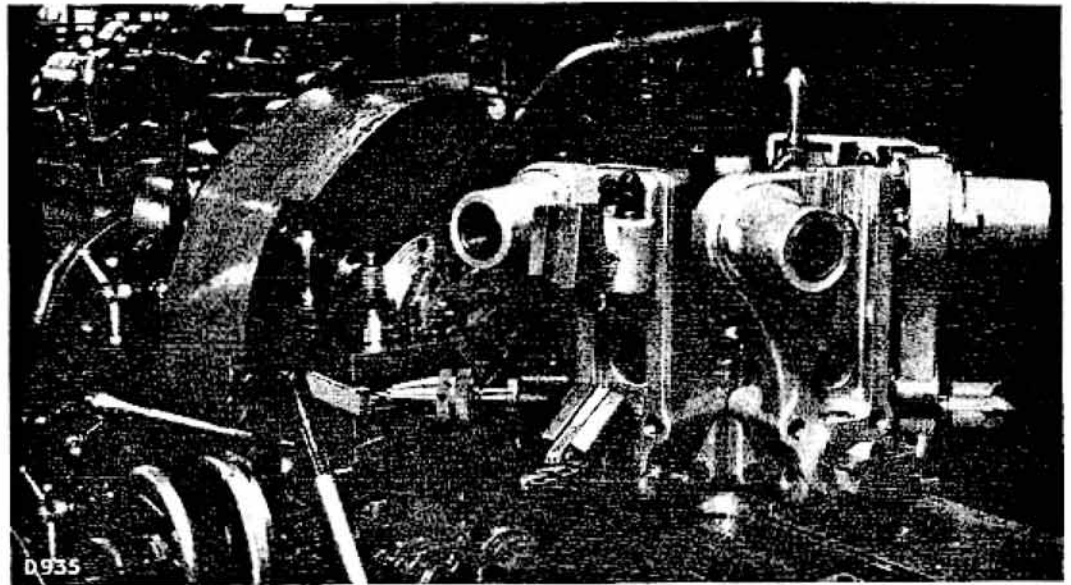
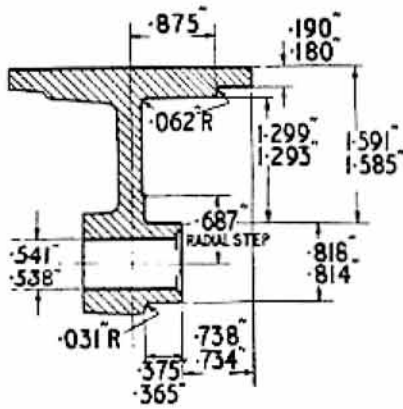

Fig. 20 (above). A cam segment is gripped in a Herbert 9" air-operated 3-jaw chuck on to which has been bolted support blocks, balance weight and adjusting screw for axial location, for its machining on a Herbert No. 4 Senior Capstan Lathe. The sequence of operations is as follows:—

Centre drill; simultaneously drill through and rough turn the $\cdot 818$ " boss; rough turn the outside diameter from the rear toolpost simultaneously with rough boring the two internal radii from the turret; rough and finish face the rim and boss; finish bore the two internal radii and chamfer mouth of the $\cdot 541$ " bore; using tools in the square turret face the web, traversing from the $\cdot 687$ " radial step towards the internal radii and face from the radial step to obtain the $\cdot 375$ -. 365 " dimension, simultaneously finish turn the boss to $\cdot 814$ -. 818 " diameter, semi-finish and chamfer the $\cdot 541$ -. 538 " bore with Microbore tools held in the turret and chamfer both edges of the rim; the $\cdot 541$ -. 538 " diameter is sized with a Coventry Adjustable Reamer.

The floor-to-floor time, 10 minutes.

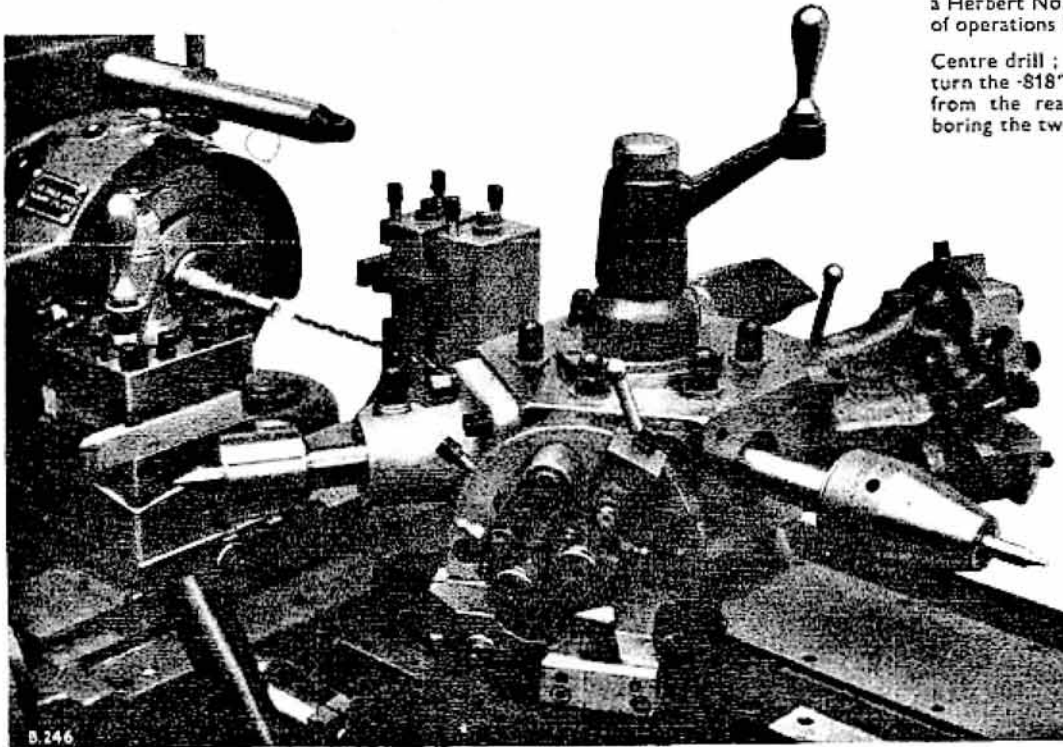

Fig. 21. The tooling (2nd operation) on a Herbert No. 2D Capstan Lathe for turning five diameters, recessing, facing, centring and drilling halfway a gearbox mainshaft. Produced from 1" diameter bright-drawn steel bar, EN.351, the mainshaft is gripped on the $\cdot 701$ -. 697 " diameter in a hand-operated dead-length bar chuck locating against the shoulder of the outside diameter. The $\cdot 638$ " and $\cdot 763$ " diameters are turned in one cut, by Chipstream Boxtools on the turret at a spindle speed of 695 r.p.m. and automatic feed of 320 cuts per inch; the shaft is supported by a live centre after centre drilling, whilst the $\cdot 798$ " and $\cdot 514$ " diameters and the recess are formed with tools held on the two toolposts on the rear of the cross slide. A parallel shank drill of special length drills a $\frac{1}{16}$ " diameter hole from the solid to a length of $4\frac{3}{8}$ " with a spindle speed of 930 r.p.m. and hand feed.

Floor-to-floor time, $4\frac{1}{2}$ minutes.

Ardoloy-tipped tools are used throughout and it will be seen that the Chipstream Boxtool is fitted with a chip deflector which diverts the long coiled turning produced into the tray of the machine. The Chiprupter fitted to the machine enables these turnings to be broken into convenient lengths for disposal whilst cutting is in progress.

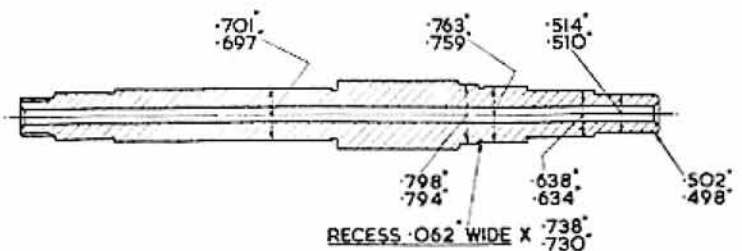
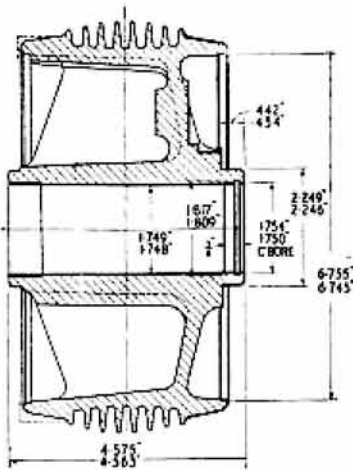

Fig. 22. At the Plumstead Works of the Associated Motor Cycles Co., two Herbert No. 4 Senior Capstan Lathes are permanently tooled for performing the two major operations on each of the front and rear hub shells. Machined from aluminium-alloy diecastings with a cast-in malleable-iron brake liner, the first operation is on the brake liner side (see D.934), the machined faces of which are used in the 2nd operation for location against studs bolted to the sector plate of the Coventry Chuck, and the faces of the three special chuck jaws. The heavy lines on the drawing indicate the surfaces machined in the 2nd operation on the rear hub shell with the set-up shown at D.933. As with all set-ups at these works, tooling is substantial—large diameter fluted boring bars with detachable multi-edged boring cutters, and adjustable floating reamers for precision machining the 1.749/1.748" diameter. Apart from the overhead support feature, extra support is provided by a live centre locating in the bore of the shell, when the outside diameter and radius are formed from the cross slide.



The floor-to-floor time for this operation is 10 minutes.

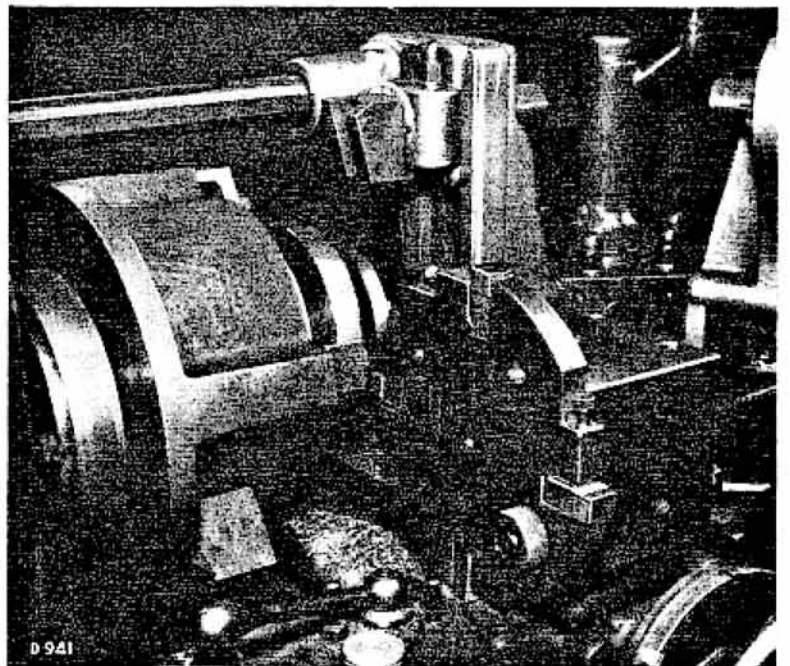
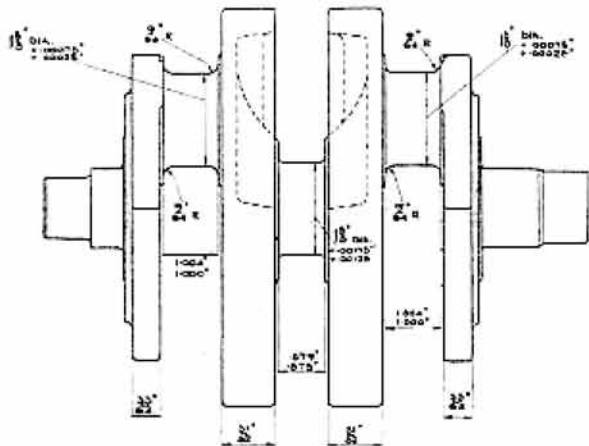
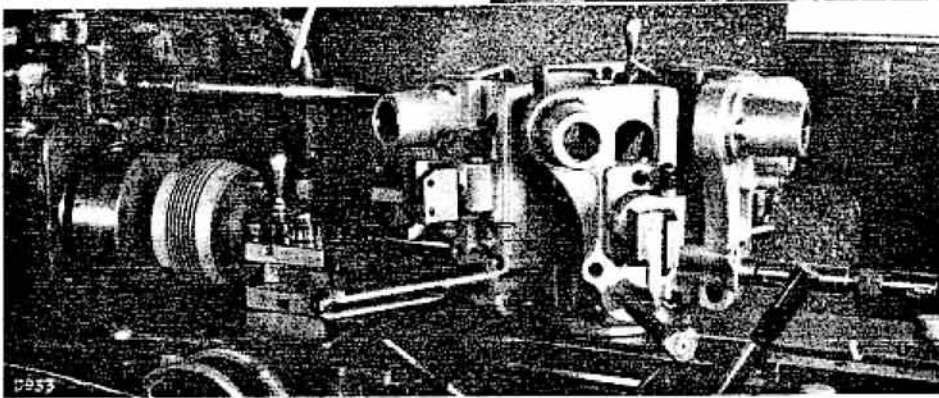
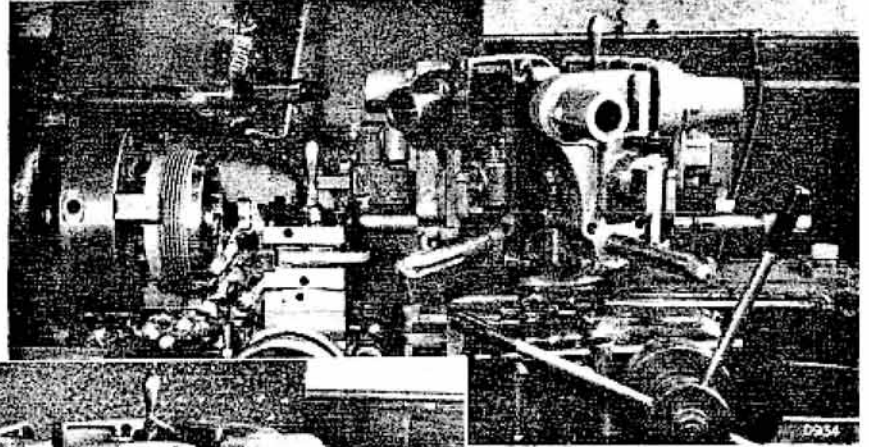

Fig. 23. An unusual vertical turret mounted on the front of the cross slide of a Herbert No. 4 Capstan Lathe, set-up for machining crankshafts. The main bearing and crankpin diameters and widths of the shrouds on single- and twin-throw crankshafts can be machined with this equipment; the chucking arrangement differs to locate either the axis of the crankpin or bearing in line with the machining axis. The illustrations show the machining of the shrouds and crankpin of a two-throw crankshaft which is set on the machine, to the crankpin axis. The front face is machined and centred, after which a live centre in the turret supports the shaft whilst the faces between the shrouds and the 1 1/2" crankpin diameter and 3/4" radii are machined.

The widths of the Ardoloy-tipped cutter blades are of a size to permit roughing and finishing cuts to produce the 1.004/1.000" and 1 1/2" + .00075/+ .00025" dimensions.

After machining, the crankshaft is reversed to repeat the operation on the other crankpin and shroud faces.

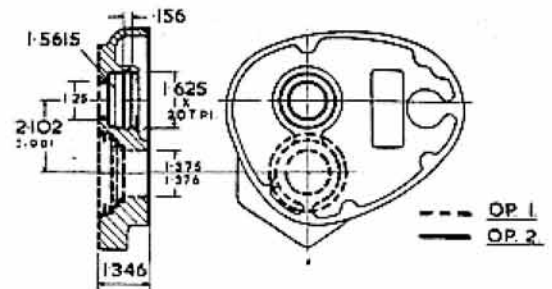
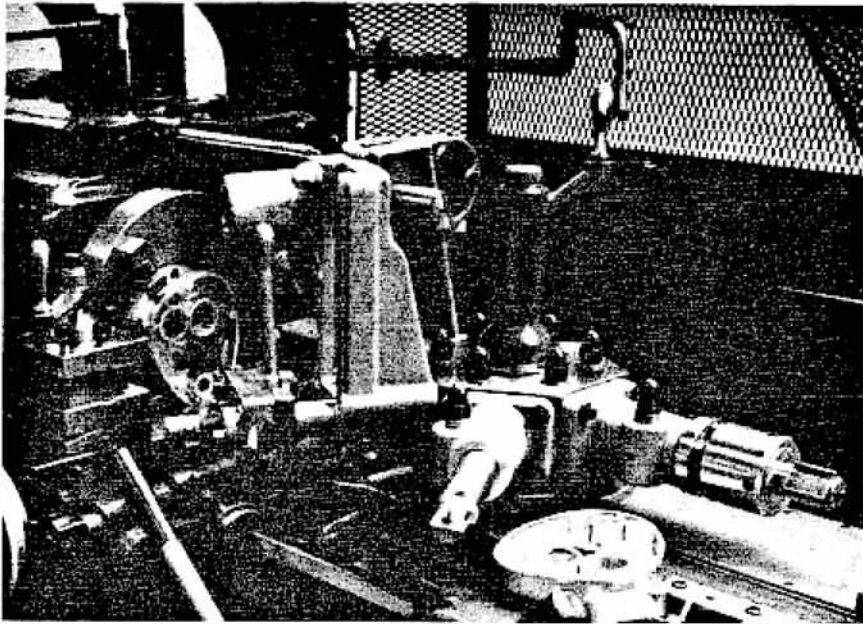

Fig. 24. The 2nd operation on a gearbox inner cover using a Herbert No. 4 Senior Capstan Lathe fitted with a hand-operated fixture bolted to the spindle flange. The aluminium-alloy diecasting is located on a plug by a previously reamed $1\frac{3}{8}$ " diameter hole and radially, on the profile, between clamping and adjusting screws.

The sequence of operations is simultaneously bore the 1.25" and 1.5615" diameters and counterbore the threaded diameter; simultaneously face the bottom of the 1.5615" diameter, form the .156" wide recess and chamfer the mouth of bore; size-bore the 1.5615" diameter, using Microbore Unit, and tap the $1\frac{3}{8}$ " \times 20 t.p.i. thread with Herbert Ground Thread Tap.

Machine the front joint face.

A spindle speed of 1,000 r.p.m. (tapping 40 r.p.m.) and either hand or automatic feed (tapping, size boring and facing) of 240 cuts per inch are used.

The floor-to-floor time, 5 $\frac{1}{2}$ minutes.

The illustration on the left shows the three Herbert Type M Multi-drill top columns mounted on a common base for drilling seven .328" diameter holes and drilling and tapping five $\frac{3}{4}$ " diameter 26 t.p.i. holes in the gearbox inner cover. The cover is clamped in a single fixture which is located by a back rail and fingers as it is moved from one operating position to the next. Floor-to-floor time for complete operation is 3 minutes.

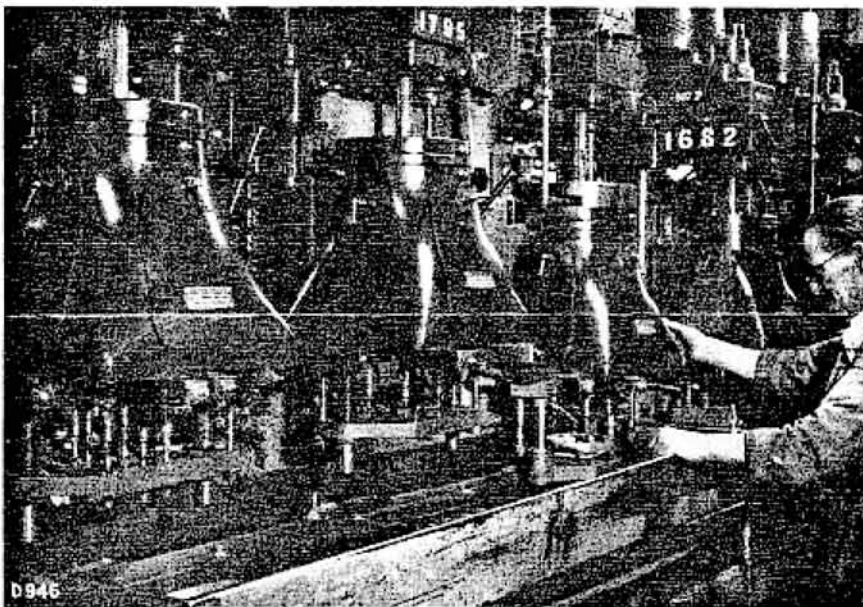

Fig. 25 (right). The operator is shown using a Herbert Single-spindle Type C Drilling Machine equipped with a work holding fixture and jig for drilling four $\frac{1}{4}$ " diameter oil holes in the timing side of the crankcase. The standard machine table has been removed to increase the vertical capacity of the machine and the drill depth indicator, of A.M.C.'s own design, assists in drilling to close limits on depth. A drill steady is bolted to the bottom column of the machine and drill guide bushes are inserted in the cross plate.

When the crankcase halves are assembled, a $1\frac{1}{2}$ " radius is milled the full width of the case to accommodate the dynamo in the power unit. This operation is also shown. Two complete crankcases are milled simultaneously; the cases are located radially on pegs fitted to the fixture which is also provided with a steady bush to pilot the milling cutter spindle as the cutter is fed down to remove approximately $\frac{3}{32}$ " of metal.

The former operation is done in 3.5 minutes, the latter in 1.33 minutes.

